

Desktop Repeater VXR-7000 (VHF) Service Manual

©2006 VERTEX STANDARD CO., LTD. E136790B

VERTEX STANDARD CO., LTD.
4-8-8 Nakameguro, Meguro-Ku, Tokyo 153-8644, Japan

VERTEX STANDARD
US Headquarters
10900 Walker Street, Cypress, CA 90630, U.S.A.

YAESU EUROPE B.V.
P.O. Box 75525, 1118 ZN Schiphol, The Netherlands

YAESU UK LTD.
Unit 12, Sun Valley Business Park, Winnall Close
Winchester, Hampshire, SO23 0LB, U.K.

VERTEX STANDARD HK LTD.
Unit 5, 20/F., Seaview Centre, 139-141 Hoi Bun Road,
Kwun Tong, Kowloon, Hong Kong

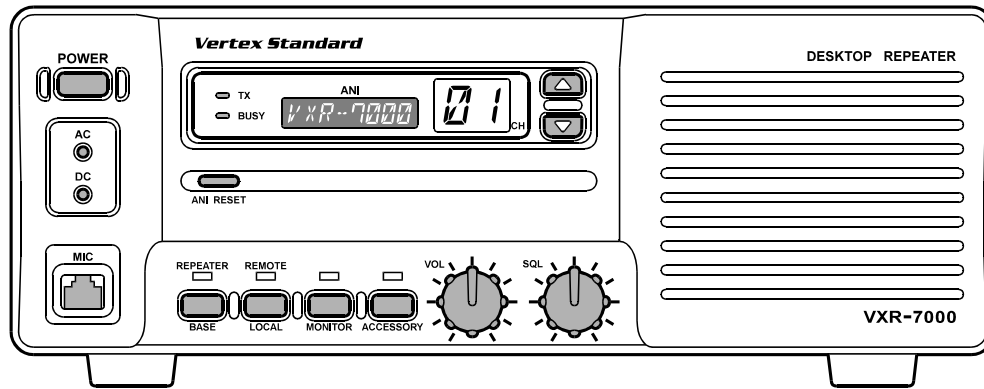

Introduction

This manual provides technical information necessary for servicing the VXR-7000 FM Land Mobile Repeater.

Servicing this equipment requires expertise in handling surface-mount chip components. Attempts by non-qualified persons to service this equipment may result in permanent damage not covered by the warranty, and may be illegal in some countries.

Two PCB layout diagrams are provided for each double-sided circuit board in the repeater. Each side of is referred to by the type of the majority of components installed on that side (“leaded” or “chip-only”). In most cases one side has only chip components, and the other has either a mixture of both chip and leaded components (trimmers, coils, electrolytic capacitors, ICs, etc.), or leaded components only.

While we believe the technical information in this manual to be correct, VERTEX STANDARD assumes no liability for damage that may occur as a result of typographical or other errors that may be present. Your cooperation in pointing out any inconsistencies in the technical information would be appreciated.

Contents

Operating Manual Reprint.....	2
CE27 Programming Software Instruction	10
Specifications	14
Exploded View & Miscellaneous Parts	15
Block Diagram	17
Interconnection Diagram.....	20
Circuit Description	21
Alignment	23

Board Unit (Schematics, Layouts & Parts)	
PA Unit (Lot.1~91)	27
PA-2 Unit (Lot.92~)	27a
TX Unit	35
RX Unit	43
CNTL Unit	55
LPF Unit (Lot.1~5)	73
Display Unit	75
Key Unit	79
Filter Unit	87
VR Unit	95
SQL Unit	97
PS Unit	99

Operating Manual Reprint

Controls & Connectors

Front Panel

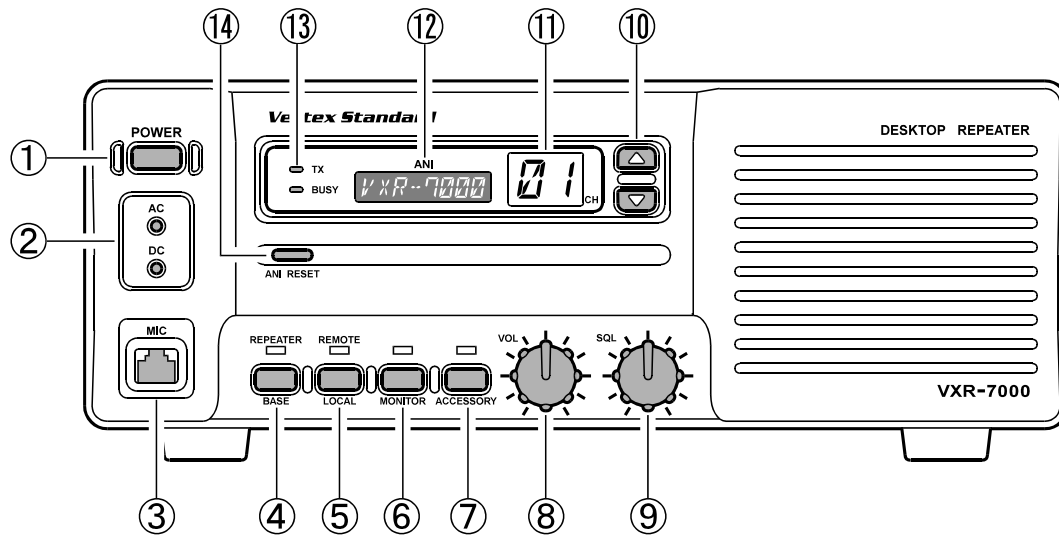

① POWER Switch

This is the main power switch for the repeater.

② LED Indicators

AC: This LED glows green during AC operation.

DC: This LED glows yellow during DC operation.

③ MIC Jack

This 8-pin modular jack accepts the microphone input, and provides a standby control line to activate the transmitter when using the “**BASE**” mode of operation. This jack also provides a “Hook” control line, as well as a “Clone Data” line.

④ BASE/REPEATER Switch

This switch toggles the operating mode between the “**REPEATER**” mode and the “**BASE**” transceiver mode. When the “**REPEATER**” mode is selected, the LED above it glows green. While in the “**BASE**” mode (the green LED is off), you can speak into the microphone to use it as a transceiver. For normal repeater operation, set this switch to the “**REPEATER**” mode.

⑤ LOCAL/REMOTE Switch

This switch toggles the control mode between the “**REMOTE**” mode and “**LOCAL**” mode. When the “**LOCAL**” mode is selected, the LED above it is off, and the repeater operates according to the control data programmed into the repeater. While in the “**REMOTE**” mode, the LED glows green, and the repeater operates according to the control instructions received from an external device (connected to the **ACC** jack on the rear panel).

⑥ MONITOR Switch

This switch selects the “**Squelch**” (receiver mute) mode. When the green LED above it is off, “**Tone**” or “**Coded**” squelch is active. When you press this switch *momentarily*, the green LED will glow steadily; in this condition, only “**noise squelch**” is active, and any signal present on the channel will be heard. If you *press and hold* this switch for more than 2 second, the green LED will blink and the squelch will open; in this condition, background noise will be heard if no signal is present.

⑦ ACCESSORY Switch

This switch can be set up for special applications, such as High/Low power selection, as determined by your Vertex Standard dealer. The LED above it glows green when this function is activated. For further details, contact your Vertex Standard dealer.

⑧ VOL Knob

This control knob adjusts the receiver volume level from the front panel speaker. If desired, this control knob may be set fully counterclockwise when repeater monitoring is not needed.

⑨ SQL Knob

This control knob selects the noise squelch threshold level. Set it to a position just above the point where the **BUSY** lamp goes out when no signal is present.

⑩ Channel Selector Buttons (▲ and ▼)

Press one of these buttons to select the operating channel.

⑪ Channel Indicator

This seven-segment LED indicates the operating channel number.

- ⑫ **ANI Display**
The ANI LCD (Liquid Crystal Display) indicates the pre-programmed ANI message according to the ANI code received.
- ⑬ **TX/BUSY Indicator**
The **BUSY** indicator glows green when the channel is busy, and the **TX** indicator glows red when the repeater is transmitting.

- ⑭ **ANI RESET Button**
 - (1) ANI
Press this button to clear the message on the ANI display, and turn off the LCD backlight.
 - (2) ENI
Press this button to turn off the Alert tone.
Press this button again to clear the message on the ANI display, and turn off the LCD backlight.

Rear Panel

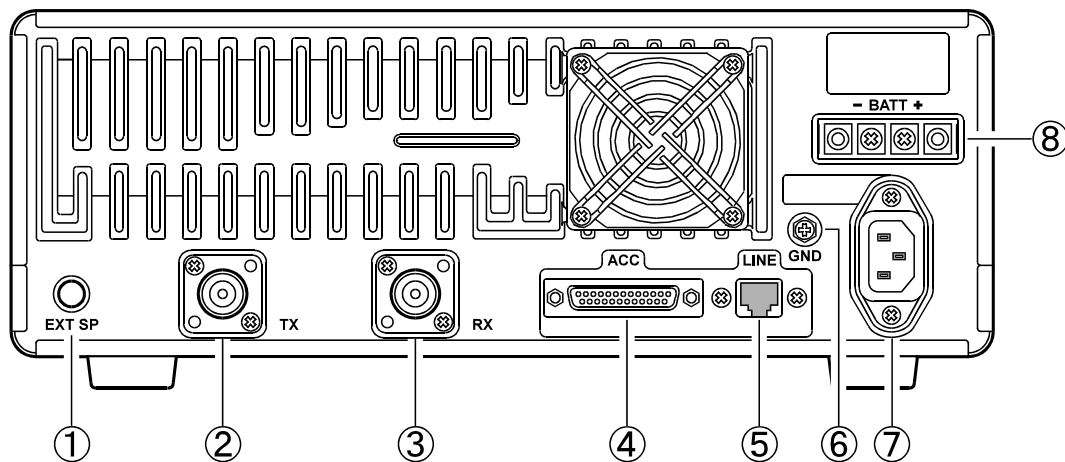

- ① **EXT SP Jack**
This 3.5-mm, 2-pin jack provides variable audio output for an external speaker. The audio output impedance at this jack is $4\ \Omega \sim 16\ \Omega$, and level varies according to the setting of the front panel's **VOL** control.
- ② **TX Antenna Jack**
This N-type coaxial jack provides the transmitting output signal for connection to the transmitting antenna or TX jack on the duplexer, if used. The output impedance requirement is $50\ \Omega$.
- ③ **RX Antenna Jack**
This N-type coaxial jack accepts the receiver input signal from the receiving antenna or RX jack on the duplexer, if used. The input impedance requirement is $50\ \Omega$.
- ④ **ACC Jack**
This DB-25 connector provides a data interface between the microprocessor in the VXR-7000 and peripheral devices (such as the VX-TRUNK Unit).
- ⑤ **LINE Jack**
This 8-pin modular jack is used for remote control. It provides TX and RX audio, TX keying, and squelch status output. The TX and RX audio impedance is $600\ \Omega$.
- ⑥ **GND Terminal**
For best performance and safety, the GND terminal should be connected to a good earth ground using a short, heavy, braided cable.
- ⑦ **AC Jack**
This receptacle accepts the AC power cord, which should be connected to the AC mains supply or wall outlet. The AC line voltage must match that for which the repeater is wired.
- ⑧ **BATT Terminal**
These terminal posts accept 12~15 VDC for operating the repeater from a battery or other DC source. When operating from AC mains, a small trickle current is present at these terminals to maintain battery charge. A battery rated for 12 volts, 55 Ah (minimum) is recommended for short-term emergency/backup operation.

Operating Manual Reprint

ACC Connector Port

The VXR-7000 repeater is provided with a 25-pin DB-25F female connector for interconnections to accessories. Use a DB-25M 25-pin male connector to connect accessories to the repeater. The pins on the accessory connector are explained in detail as follows:

Pin 1: **GND**

Chassis ground for all logic levels and power supply return.

Pin 2: **+13.8 V** [Power Supply]

This pin provides 13.8 Volts, 1.0 A, regulated DC from the repeater supply. Use a 1 A fuse in the external device's DC line to prevent damage to the repeater.

Pin 3: **TX AF IN** [Analog Transmitter Input]

(Voice Band: 300 ~ 3,000 Hz)

Input impedance is approx. 600 Ω . This audio is injected before the splatter filter stage, so excess signal input levels are clipped.

Use shielded cable to connect to this pin, and connect the shield to **GND**.

Pin 4: **TONE IN** [Transmitter Input]

(Sub-audible Band: 6 ~ 250 Hz)

The input is high impedance (approx. 22 k Ω). Injecting too high a voltage here causes over-deviation of CTCSS or DCS, degrading performance. Use shielded cable to connect to this pin, connecting the shield to **GND**.

Pin 5: **N.C.** (No connection.)

Pin 6: **DISC OUT** [Analog Output]

(Wide-Band: 0 ~ 3,000 Hz)

Received signals with standard deviation produce approx. 1 V_{P-P} audio at this pin. The output impedance is approx. 600 Ω , and is extracted before the de-emphasis and squelch circuitry. Use shielded cable to connect to this pin, and connect the shield to **GND**.

Pin 7: **GND**

Chassis ground for all logic levels and power supply return.

Pin 8: **RSSI** [Analog Output]

A DC voltage proportional to the strength of the signal currently being received (**R**eceiver **S**ignal **S**trength **I**ndicator) is provided on this pin. This low impedance output is generated by the receiver IF sub-system and buffered by an internal op-amp. Typical voltages are graphed as follows:

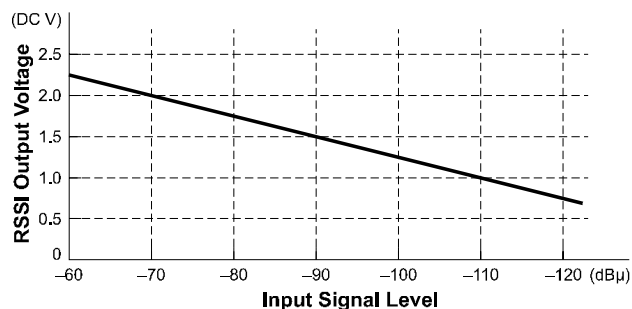

Pin 9: **COAX. SW** [Logic Output (Active Low)]

This output is intended for controlling an external coaxial switching relay. It is an open collector output which can sink approx. 10 mA when active. This signal only switches if the repeater has been programmed for "**SIMPLEX**" mode. If programmed for "**DU-PLEX**," the signal remains open (high impedance) at all time.

Pin 10: **N.C.** (No connection.)

Pin 11: **NSQ DET**

This is an open-collector, active-low output capable of sinking about 10 mA. It indicates that the receiver squelch is open. If the squelch control is properly set, this indicates a carrier on the receiver channel.

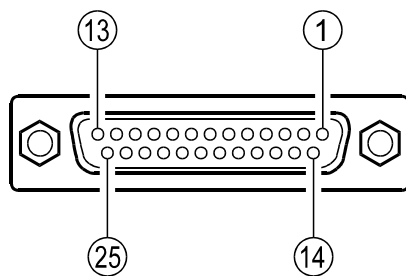

**ACC Jack
DB-25 Pin Numbering**

Operating Manual Reprint

Pin 12: EXT PTT

This input is internally pulled up to 5 VDC. When pulled low by an external device, it keys the repeater transmitter while the repeater is operating in the “*BASE*” mode. Avoid voltage in excess of 5 V on this pin, or internal damage to the microprocessor on the repeater CNTL Unit may result.

Pin 13: GND

Chassis ground for all logic levels and power supply return.

Pin 14: GND

Chassis ground for all logic levels and power supply return.

Pin 15: N.C. (*No connection.*)

Pin 16, 17, 18, & 19: REMOTE CH DATA

[Logic Inputs D3, D2, D1, and D0] (*Active Low*)

These inputs are internally pulled up to 5-V DC. When pulled low by an external device, they select one of the 16 pre-programmed repeater operating channels. The logic truth table below shows the combinations for selecting all 16 channels.

In the truth table, “1” represents no connection, and “0” represents a ground connection on the pin.

The channel selection logic is not inhibited while the transmitter is keyed: the repeater will change frequency when instructed, even while transmitting.

Avoid voltage in excess of 5 V on these pins or internal damage to the microprocessor on the repeater CNTL Unit may result.

Channel	Pin 16 (D3)	Pin 17 (D2)	Pin 18 (D1)	Pin 19 (D0)
1	1	1	1	1
2	1	1	1	0
3	1	1	0	1
4	1	1	0	0
5	1	0	1	1
6	1	0	1	0
7	1	0	0	1
8	1	0	0	0
9	0	1	1	1
10	0	1	1	0
11	0	1	0	1
12	0	1	0	0
13	0	0	1	1
14	0	0	1	0
15	0	0	0	1
16	0	0	0	0

Pin 20: GND

Chassis ground for all logic levels and power supply return.

Pin 21: A-OUTPUT [Logic Output] (*Active Low*)

This open collector logic output is pulled low when the front panel’s **ACCESSORY** key is turned on. It can sink approx. 10 mA when active.

Pin 22: RXD LOW

[Digital Output for DATA Communications]
(300 ~ 3,000 Hz)

This pin is an output for low speed receiving data signals, with the data being extracted after the de-emphasis and low pass filter stages.

Pin 23: RXD HI

[Digital Output for DATA Communications]

This pin is an output for high speed receiving data signals, with the data being extracted immediately after the discriminator prior to any de-emphasis).

Pin 24: TXD LOW

[Digital Input for DATA Communications]
(300 ~ 3,000 Hz)

This pin is intended to be used as a low speed digital data signal input to the repeater. This digital data signal is injected before transmitter pre-emphasis and limiting stage, so excess signal input levels are clipped.

Pin 25: TXD HI

[Digital Input for the DATA Communications]

This pin is intended to be used as a high speed digital data signal input to the repeater. This digital data signal is injected after transmitter splatter filter stage.

Operating Manual Reprint

LINE Interface Port

The VXR-7000 is provided with an 8-pin modular jack for line interfacing applications. A Western Electric® modular-type RJ45 plug should be used to connect to this jack. The **LINE** jack pin-out is shown below.

Note that there are both 4-line and 8-line types of modular plugs. If a 4-line modular plug is used, only the **LINE OUT** and **LINE IN** connections will be made. An 8-line plug is required to access all lines. In accordance with standard telecommunications interface, the line connections on the **LINE** interface jack are impedance balanced, and are described as follows.

Pins 1 & 2: [**RX SQ(+)**, **RX SQ(-)**]

(max voltage: 20 V, max current: 7 mA)

An opto-isolator is provided to facilitate E (EAR) signaling. The opto-isolator comes on when a signal exceeding the receiver squelch appears on the receiver channel (with correct CTCSS tone or DCS code, if enabled). The **RX SQ(-)** pin is the emitter, and **RX SQ(+)** is the collector.

Pins 3 & 4: [**LINE IN** (*Tx Line Audio*)]

Analog signals between 300 and 3000 Hz supplied to this pair are fed to the transmitter when the repeater is set to the BASE mode (the **REPEATER** LED is turned off) and keyed either by the **TX KEY** input signal (see below), or by the **EXT PTT** signal on pin 12 of the rear panel's **ACC** jack. Standard deviation is obtained with a line level of -10 dBm.

Pins 5 & 6: [**LINE OUT** (*Rx Line Audio*)]

Receiver audio is available from this pair, subject to internal CTCSS or DCS decode if the received signal strength is above the squelch threshold.

As shipped from the factory, a 1-kHz receiver signal with standard deviation gives -10 dBm on the line, but this can be varied by **VR4002** and **S4001** (on the repeater's CNTL Unit).

Pins 7 & 8 [**TX KEY(+)**, **TX KEY(-)**]

(max voltage: 20 V, max current: 4 mA)

An opto-isolator is provided to facilitate M (MIC) signaling. That is, a voltage presented to these pins turns on the opto-isolator and keys the transmitter. The **TX KEY(+)** pin is the anode of the opto-isolator, and **RX SQ(-)** is the cathode of the opto-isolator.

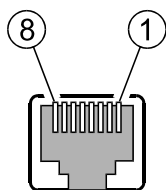

LINE Jack
Modular Jack Pin Numbering

Installation

Antenna Considerations

Repeater operation without a duplexer requires that two antennas be installed, one for receiving and one for transmitting, so that the receiving antenna does not absorb energy from the transmitting antenna. There are a number of ways to do this, depending on the TX/RX frequency separation, and on the locations available for antenna mounting. If a duplexer is used, a single antenna suffices for both transmitting and receiving. If using a reduced-size duplexer, a six-cavity model (minimum) is recommended. Vertex Standard recommends the use of the duplexer. For further details, contact your Vertex Standard dealer.

Regardless of the above choice, it is of paramount importance that the antenna(s) be mounted as high and in the clear as possible, preferably within line-of-sight to all repeater users. Furthermore, losses in the feedline(s) must be minimized, so the feedline(s) should be high quality, and as short as possible. If a long feedline is necessary, use coaxial "hardline" cable to reduce losses.

Repeater antennas should have an impedance of 50 Ω at the operating frequency. When separate receive and transmit antennas are used, high-Q narrow-band types may serve to minimize interaction. However, when a single antenna is used with a duplexer, it should be a low-Q wide-band type.

NEVER TRANSMIT WITHOUT HAVING A TRANSMIT ANTENNA CONNECTED TO THE TX ANTENNA JACK OF THE REPEATER.

AC Power Supply Voltage Selection

Each repeater is wired for a particular AC mains voltage between 100 and 253 VAC. This should be indicated by a label near the AC jack on the rear panel. If no label is present, or if the AC voltage on the label is different from the local AC line, check the wiring inside the Switching Regulator Unit of the repeater, and change the connections (and label) if necessary, as shown page 8.

Changing the AC input voltage wiring also requires changing the fuse on the FILTER Unit if the voltage is changed from 100 VAC (100-127 VAC) to 200 VAC (207-253 VAC), or vice-versa. Use a 5-amp fuse for 100 VAC, or a 3-amp fuse for the 200 VAC.

DC Power Supply Backup

For uninterrupted operation during power failures, a 12 volt rechargeable type battery (55-Ah or more recommended) may be connected to the **BATT** terminal posts on the rear panel. While the repeater is operating from the AC source, a slight charging current will maintain battery charge. In the event of an AC power outage, the automatic power control circuit will automatically switch the repeater to the backup battery, and operation will not be interrupted.

After prolonged operation from the battery, it should be disconnected from the repeater and recharged separately before re-connecting, as the trickle charge is not sufficient for recharging a completely discharged battery.

Never reapply AC power to the repeater with a discharged battery connected, as the DC startup current can damage the repeater and battery.

While operating from a battery or DC supply, the repeater requires approximately 7 amperes at 12 Volts during transmit.

Equipment Location

While the operating temperature range of the repeater is quite broad, the best location is one in which the air temperature does not approach the extremes of the specified range, and one that does not change rapidly. Make sure to allow for free air flow around the heatsink on the rear apron at all times. In warm climates, the repeater should not be sealed in a small closed room.

Protect the repeater from wind and rain, and extremes in temperature or humidity that may shorten the useful life of the equipment. Try to locate the repeater in an environment that is also comfortable for service personnel, if possible.

Operating Manual Reprint

Changing Switching Regulator unit AC Mains Jumper Wiring

Before attempting this jumper wire change, remove the AC power cord from the AC jack on the rear panel.

- ❑ Referring to Figure 1, remove the 14 screws affixing the top and bottom covers of the repeater, and remove the covers.
- ❑ Remove the eight screws affixing the shield cover for the FILTER Unit, and remove the cover (see Figure 1).
- ❑ Disconnect all wires and connectors from the FILTER Unit, then remove the six screws affixing the Switching Regulator Unit, and remove it (the Switching Regulator Unit is mounted with the FILTER Unit: Figure 2).
- ❑ Referring to Figure 3, remove the four screws and remove the heatsink from the Switching Regulator Unit.

- ❑ Referring to Figure 4, perform the correct jumper wiring on the Switching Regulator Unit for the AC Mains voltage used in your area (100-127 VAC or 207-253 VAC).
- ❑ Replace the heatsink onto the Switching Regulator Unit, then replace the Switching Regulator Unit onto the chassis, and connect all wires and connectors to the FILTER Unit.
- ❑ Replace the AC fuse (**FH6001**) on the FILTER Unit according to the AC Mains voltage range:
 - 100 VAC (100-127 VAC): 5A
 - 200 VAC (207-253 VAC): 3A.
- ❑ Replace the shield cover and replace the top and bottom covers. This completes the wiring change.

Important!: If you change the AC voltage range, you must also change the AC fuse on the FILTER Unit. Do not replace with a slow-blow type fuse.

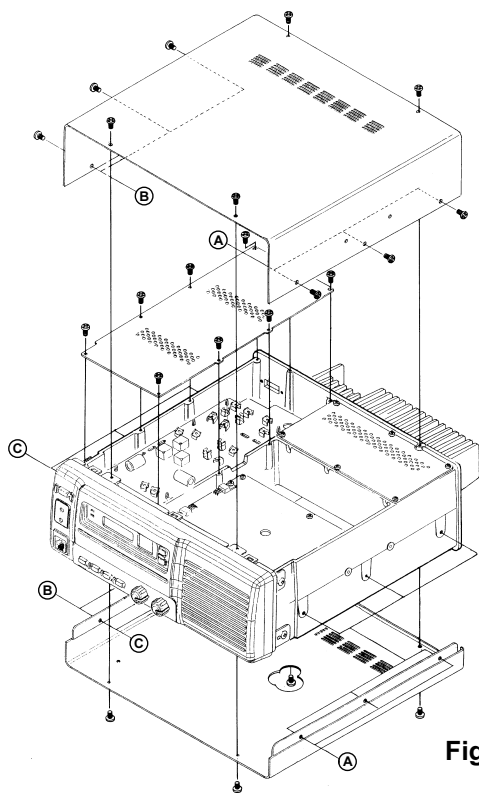

Figure 1

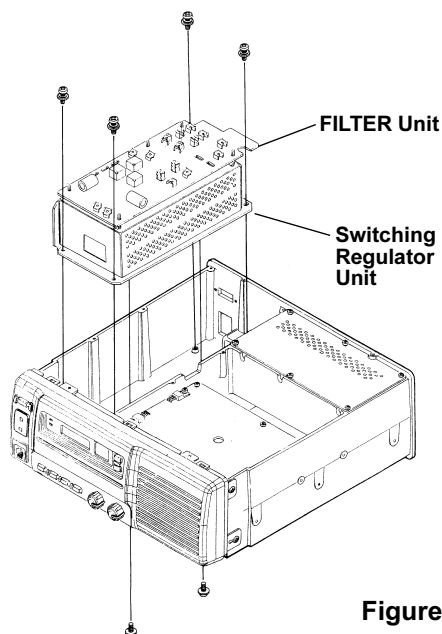

Figure 2

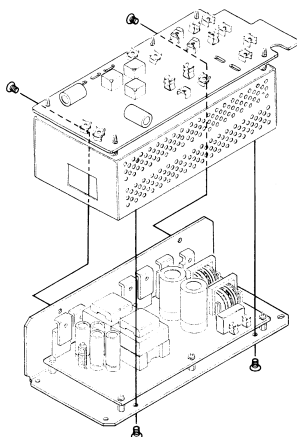

Figure 3

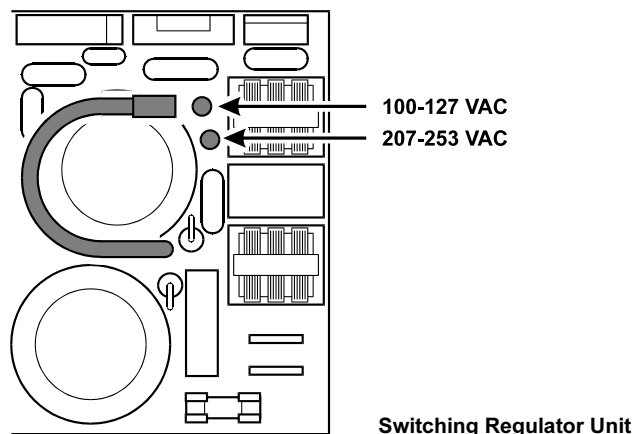

Figure 4

CE-27 Programming Software Instruction

With the CE27 Programming Software, you can quickly and easily program the Vertex Standard VXR-7000 repeater's channels and configuration from your personal computer. In the event of an accidental memory failure, repeater memory and configuration data may be re-loaded in a matter of minutes.

The CE27 Programming Software diskette contains the following files:

- CE27.EXE
- CE27.HLP

Before connecting the VXR-7000 for programming, turn off both the computer and the VXR-7000. Now connect the VPL-1 Connection Cable to the computer's serial port and the VXR-7000.

Then it will be safe to restart the computer; turning off the equipment during interconnection avoids the potential for damage to the electronics caused by voltage spikes.

Insert the distribution diskette into your 3½" drive (after booting DOS), and make a copy of the diskette; use the distribution diskette for archive purposes, and use the disk copy for programming.

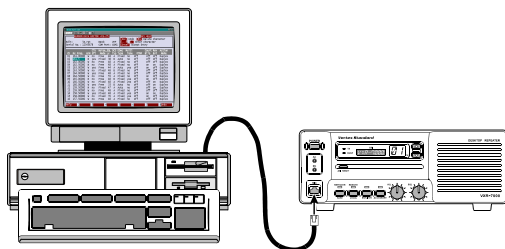

VXR-7000 Programming Setup

Place the CE27 (copy) diskette into your 3½" drive (usually "Drive A"), and log onto this drive by typing "A: [ENTER]", then load the contents of the CE27 diskette into a directory named CE27, using the COPY command (e.g. "COPY A:*.* C:\CE27").

Now type "CE27 [ENTER]" to start the program. The introductory screen will appear, and you may press any key to enter the main screen.

Choose the "Help" contents option (F1) from the program's Menu for assistance with channel programming or setting of parameters.

Important Note!

- Do not run the CE27 programming software directly from the original distribution diskette. Copy the programming software to your computer's hard disk, then run the software from the hard disk only. Keep the original distribution diskette in a safe place in case you need to make another copy of it at a later date.
- Before creating the programming data for your VXR-7000 via the CE27 programming software, upload the current factory hardware environment data from the VXR-7000, using the [F5] (ReadRom) command. Use this data profile to create the programming data for this repeater.

MS-DOS - CE27

EEPROM DATA EDITOR <CE-27> KEY HELP

Edit: noname rpt Band: VHF 0.9 Input Frequency
 Serial No.: 12345678 COM Port: COM1 [.] Enter 100kHz Digit...

Ch	Rx Freq.	Decoders	Clk	NSQ	Court	Rev	DCS	DDec	Multi	CHID
		CTCSS DCS W/N Sft	Mode	Lv	Blip	Bst	Typ	Type	Tone	ANI/ENI
01	161.00000	88.5 off	W	no	off	off	A	Fixed	no	off
02	161.05000	100.0 off	W	no	off	off	A	Fixed	no	off
03	161.01000	off	W	no	off	off	A	Fixed	no	off
04	161.01500	off	W	yes	off	off	A	Fixed	no	off
05	161.02000	off	W	no	off	off	A	Fixed	no	off
06	161.02500	88.5 on	W	no	off	off	A	Fixed	no	off
07	161.03000	114.0 on	W	no	off	off	A	Fixed	no	off
08	161.03500	off	W	no	off	off	A	Fixed	no	off
09	161.04000	off	W	no	off	off	A	Fixed	no	off
10	161.04500	off	W	no	off	off	A	Fixed	no	off
11	161.05000	100.0 off	W	no	off	off	A	Fixed	no	off
12	161.05500	88.5 on	W	no	off	off	A	Fixed	no	off
13	161.06000	100.0 off	W	no	off	off	A	Fixed	no	off
14	161.06500	off	W	no	off	off	A	Fixed	no	off
15	161.07000	off	W	yes	off	off	A	Fixed	no	off
16	161.07500	off	W	no	off	off	A	Fixed	no	off
		79.7 off	W	no	off	off	A	Fixed	no	off
		off	W	no	User	127	off	Fixed	no	off

1Help 2Common 3DiskLoad 4DiskSave 5Read ROM 6WriteROM 7PrintOut 8Quit

CE27 Main Screen (Left)

Operating Manual Reprint

Channel Data Items

Ch: Channel Number

This 2-digit number (01 - 16) is used to identify the channel. Channel numbers occur in sequence, and their order can not be changed.

Rx Freq.: Edit Receive (or simplex) Frequency

Use the [0] - [9] keys to enter the desired channel frequency directly, and press the [ENTER] key.

CTCSS Decoders: Toggle CTCSS Decoder ON/OFF, sets CTCSS Frequency

Press the [SPACE] bar to toggle the CTCSS Decoder “on” or “off,” or press the [ENTER] key to display the “TONE SELECT” window, from which

you may select a CTCSS frequency using the [ARROW] key; press [ENTER] again to accept the selected tone, or press [Esc] key to cancel.

Tone	Select	71	74
67.0	off	off	off
67.2	off	off	off
67.4	off	off	off
67.6	off	off	off
67.8	off	off	off
68.0	off	off	off
68.2	off	off	off
68.4	off	off	off
68.6	off	off	off
68.8	off	off	off
69.0	off	off	off
69.2	off	off	off
69.4	off	off	off
69.6	off	off	off
69.8	off	off	off
70.0	off	off	off
70.2	off	off	off
70.4	off	off	off
70.6	off	off	off
70.8	off	off	off
71.0	off	off	off
71.2	off	off	off
71.4	off	off	off
71.6	off	off	off
71.8	off	off	off
72.0	off	off	off

DCS Decoders: Toggle DCS Decoder ON/OFF, sets DCS Code #

Press the [SPACE] bar to toggle the DCS Decoder ON or OFF, or press the [ENTER] key to display the “CODE SELECT” window, from which you

may select a DCS code using the [ARROW] key; press [ENTER] again to accept the selected code, or press the [Esc] key to cancel.

Code	Select	031	032	035	043	047
023	off	off	off	off	off	off
025	off	off	off	off	off	off
026	off	off	off	off	off	off
031	off	off	off	off	off	off
032	off	off	off	off	off	off
035	off	off	off	off	off	off
043	off	off	off	off	off	off
047	off	off	off	off	off	off
052	off	off	off	off	off	off
054	off	off	off	off	off	off
056	off	off	off	off	off	off
057	off	off	off	off	off	off
059	off	off	off	off	off	off
062	off	off	off	off	off	off
064	off	off	off	off	off	off
067	off	off	off	off	off	off
073	off	off	off	off	off	off
703	off	off	off	off	off	off
712	off	off	off	off	off	off
723	off	off	off	off	off	off
731	off	off	off	off	off	off
732	off	off	off	off	off	off
734	off	off	off	off	off	off
743	off	off	off	off	off	off
754	off	off	off	off	off	off

W/N: Wide/Narrow Channel Spacing

This function selects the channel spacing environment in which the VXR-7000 operates.

W (Wide) = 25 kHz Channel Spacing, ±5 kHz Deviation.

N (Narrow) = 12.5 kHz Channel Spacing, ±2.5 kHz Deviation.

Press the [SPACE] bar to select the desired channel spacing environment.

Clk Sft: Enable/disable the CPU Clock Shift

This function is only used to move a spurious response “birdie” should it fall on a current frequency.

Press the [SPACE] bar to toggle “yes” or “no.”

NSQ Mode: Noise Squelch Mode

This command selects the manner of setting of the Squelch threshold level.

User = The squelch threshold level is fixed via the “NSQ Lv” parameter (**NSQ Lv:** 0 [min.] ~ 255 [max.]).

Prpgram = The squelch threshold level determined via the dealer programming.

Press the [SPACE] bar to select the desired NSQ Mode.

NSQ Lv: Noise Squelch threshold level

Use the [0] - [9] keys to enter the desired Squelch threshold level directly, and press the [ENTER] key. Available values are 0 (min.) ~ 255 (max.).

Court Blip: Courtesy Blip

When this parameter is set to “on,” this function causes the VXR-7000 to send out a “blip” on the portable/mobile radio is frequency each time the portable radio is unkeyed. This provides audible confirmation to the user that the VXR-7000 was able to receive the transmission from the portable.

Press the [SPACE] bar to toggle “on” or “off.”

Rev Bst: Reverse Burst.

When this parameter is set to “on,” the CTCSS tone signal’s phase is inverted just before the repeater turns to receive. This allows the portable/mobile station’s CTCSS Decoder to begin switching off, thus reducing the transition time required.

Press the [SPACE] bar to toggle “on” or “off.”

DCS Typ: DCS Format

This command is effective only when DCS is chosen for squelch control.

A = “Normal” DCS

B = “Inverted” (complement) DCS

Press the [SPACE] bar to select the desired DCS Type.

DDec Type: DCS Decoder Type

This command selects the manner in which DCS is to be decoded.

Fixed = Decodes only the type selected in above parameter (**DCS Typ:** Normal or Inverted).

Auto = Both types (Normal and Inverted) will be decoded.

Press the [SPACE] bar to select the desired DCS Decoder Mode.

Ch	Action Mode	Tx Freq.	Encoders CTCSS DCS	Base TOT	Base Guard	Base LOUT	TX Pwr	TOT Mute	Rpt Use	TOT Beep	RPT HT	RPT GT
01	Duplex	161.50000	88.5 off	no	no	off	Hi	off	no	no	no	no
02	Duplex	161.55000	100.0 off	no	no	off	Lo	off	no	no	no	no
03	Duplex	161.60000	off	no	no	BTL0	Lo	off	no	no	no	no
04	Duplex	161.65000	off	no	no	off	Hi	off	no	no	no	no
05	Duplex	161.70000	off	no	no	off	Hi	off	no	no	no	no
06	Duplex	161.75000	88.5 off	no	no	off	Hi	off	no	no	no	no
07	Duplex	161.80000	114.0 off	no	no	off	Hi	off	no	no	no	no
08	Duplex	161.85000	off	no	no	off	Hi	off	no	no	no	no
09	Duplex	161.90000	off	no	no	off	Hi	off	no	no	no	no
10	Duplex	161.95000	off	no	no	BCL0	Hi	off	no	no	no	no
11	Duplex	162.00000	100.0 off	no	no	off	Hi	off	no	no	no	no
12	Duplex	162.05000	100.0 off	no	no	off	Hi	off	no	no	no	no
13	Duplex	162.10000	100.0 off	no	no	off	Hi	off	no	no	no	no
14	Duplex	162.15000	off	no	no	off	Hi	off	no	no	no	no
15	Duplex	162.20000	79.7 off	no	no	off	Hi	off	no	no	no	no
16	Duplex	162.25000	off	yes	yes	BCL0	Hi	on	yes	yes	yes	yes

CE27 Main Screen (Scrolled Right)

Operating Manual Reprint

Multi Tone: Enable/disable Multi Tone Operation

Press the [SPACE] bar to toggle Multi Tone Operation between selections “yes” and “no.”

Press the [ENTER] key to display the “MULTI TONE SELECT” window, from which you may select a CTCSS tone or DCS code; move the cursor to the appropriate field

Multi Tone Select(CH-1)			
Tone	01	DCS	003
Tone	02	108	003
Tone	03	110	023
Tone	04	115	003
Tone	05	120	003
Tone	06	135	003
Tone	07	150	003
Tone	08	155	003

you using the [ARROW] key, then press the [ENTER] key to open the “TONE SELECT” or “CODE SELECT” window. Now select the desired CTCSS tone or DCS code using the [ARROW] key, then press the [ENTER] key again to accept the selected tone or code, or press the [Esc] key to cancel. You may set as many as 16 CTCSS tones and/or DCS codes.

Note that, if you do not yet program a CTCSS tone or DCS code in the “MULTI TONE SELECT” window (when the “MULTI TONE SELECT” window data is not programmed), press the [SPACE] bar to display the “MULTI TONE SELECT” window directly.

CWID ANI/ENI: Select the Identifier mode

Press the [SPACE] bar to toggle the selections “CW ID,” “ANI/ENI,” or “off.” To select this feature to the “CW ID” or “ANI/ENI,” the “CW ID” parameter must be enabled via the dealer programming.

Action Mode: Select the repeater operation mode

Press the [SPACE] bar to toggle between “Duplex” operation or “Simplex” operation.

Tx Freq.: Edit Transmit Frequency

Use the [0] - [9] keys to enter the desired channel frequency directly, and press the [ENTER] key.

CTCSS Encoders: Toggle CTCSS Encoder ON/OFF, sets CTCSS Frequency

Press the [SPACE] bar to toggle the CTCSS Encoder “on” or “off,” or press the [ENTER] key to display the “TONE SELECT” window, from which you may select a CTCSS frequency using the [ARROW] key; press [ENTER] again to accept the selected tone, or press the [Esc] key to cancel.

Tone	Select
67	71
69	74
70	77
71	80
72	83
73	86
74	89
75	92
76	95
77	98
78	101
79	104
80	107
81	110
82	113
83	116
84	119
85	122
86	125
87	128
88	131
89	134
90	137
91	140
92	143
93	146
94	149
95	152
96	155
97	158
98	161
99	164
100	167
101	170
102	173
103	176
104	179
105	182
106	185
107	188
108	191
109	194
110	197
111	200
112	203
113	206
114	209
115	212
116	215
117	218
118	221
119	224
120	227
121	230
122	233
123	236
124	239
125	242
126	245
127	248
128	251
129	254
130	257
131	260
132	263
133	266
134	269
135	272
136	275
137	278
138	281
139	284
140	287
141	290
142	293
143	296
144	299
145	302
146	305
147	308
148	311
149	314
150	317
151	320
152	323
153	326
154	329
155	332
156	335
157	338
158	341
159	344
160	347
161	350
162	353
163	356
164	359
165	362
166	365
167	368
168	371
169	374
170	377
171	380
172	383
173	386
174	389
175	392
176	395
177	398
178	401
179	404
180	407
181	410
182	413
183	416
184	419
185	422
186	425
187	428
188	431
189	434
190	437
191	440
192	443
193	446
194	449
195	452
196	455
197	458
198	461
199	464
200	467

DCS Encoders: Toggle DCS Encoder ON/OFF, sets DCS Code

Press the [SPACE] bar to toggle the DCS Encoder “on” or “off,” or press the [ENTER] key to display the “CODE SELECT” window, from which you may select a DCS code using the [ARROW] key; press [ENTER] again to accept the selected code, or press the [Esc] key to cancel.

Code	Select
02	026
03	031
04	036
05	041
06	046
07	051
08	056
09	061
10	066
11	071
12	076
13	081
14	086
15	091
16	096
17	101
18	106
19	111
20	116
21	121
22	126
23	131
24	136
25	141
26	146
27	151
28	156
29	161
30	166
31	171
32	176
33	181
34	186
35	191
36	196
37	201
38	206
39	211
40	216
41	221
42	226
43	231
44	236
45	241
46	246
47	251
48	256
49	261
50	266
51	271
52	276
53	281
54	286
55	291
56	296
57	301
58	306
59	311
60	316
61	321
62	326
63	331
64	336
65	341
66	346
67	351
68	356
69	361
70	366
71	371
72	376
73	381
74	386
75	391
76	396
77	401
78	406
79	411
80	416
81	421
82	426
83	431
84	436
85	441
86	446
87	451
88	456
89	461
90	466
91	471
92	476
93	481
94	486
95	491
96	496
97	501
98	506
99	511
100	516

Base TOT: Enable/disable the Time-Out Timer while in the “BASE” station mode

Press the [SPACE] bar to toggle the TOT feature selects “yes” and “no.”

The TOT time is determined via dealer programming.

Base Guard: Enable/disable the Base Guard Feature

When this parameter is set to “yes,” the transmitter will be inhibited for a few seconds before the repeater (in the “BASE” station mode) turns to receive.

The inhibit time is determined via dealer programming.

LOUT: Select the Lock Out Feature’s mode

Press the [SPACE] bar to toggle the Lock Out Feature between “BCLO,” “BTLO,” or “off,” then press the [ENTER] key to accept the setting. “BCLO” inhibits transmitting while there is carrier present. “BTLO” inhibits transmitting while there is carrier present unless there also is a valid tone present.

TX Pwr: Transmitter Power Output Selection

This parameter selects the desired power output from the VXR-7000 on the current channel. The available values are HIGH and LOW.

Press the [SPACE] bar to select “Hi” or “Lo.”

TOT Mute: Enable/disable the TOT (Time-Out Timer) beep monitoring

When this parameter is set to “on,” the alert beep will sound from the front panel speaker before the repeater turns itself off.

RptTOT Use: Enable/disable the Time-Out Timer while operating in the repeater mode

Press the [SPACE] bar to toggle the Repeater TOT selects “yes” or “no.”

The TOT time is determined via dealer programming.

RptTOT Beep: Enable/disable the TOT beep Transmission

Press the [SPACE] bar to toggle the TOT beep selects “yes” or “no.”

When this parameter is set to “yes,” the alert beep will be sent out on the air before the repeater turns itself off, while operating in the “REPEATER” mode.

RPT HT: Enable/disable the Repeater Hang-on Timer

Press the [SPACE] bar to toggle the Repeater Hang-on Timer selects “yes” or “no.”

When this parameter is set to “yes,” the repeater will remain keyed for a desired seconds after a receiving carrier is dropped.

The Hang-up time is determined via dealer programming.

RPT GT: Enable/disable the Repeater Guard

When this parameter is set to “yes,” the transmitter inhibit few second before the repeater is unkeyed.

The inhibit time is determined via dealer programming.

Operating Manual Reprint

Duplexer Installation

Important Note

Be certain to observe the specifications for Frequency Separation and Maximum Transmitter Power of the duplexer connected to the VXR-7000. The Frequency Separation should be 5 MHz (min.) to 10 MHz (max.), and the Maximum TX Power Rating should be at least 40 Watts.

If the VXR-7000 TX output power or frequency specification is out of the range of the duplexer's capability, you may re-program the Tx/Rx frequency pair and/or reduce the TX output power of the VXR-7000, so as to allow temporary operation of the VXR-7000 until a duplexer of proper ratings can be obtained.

Please consult with your Authorized Vertex Dealer for assistance with procurement of a suitable duplexer.

1. Connect the VXR-7000's TX antenna port to a watt-meter and dummy load (the duplexer must not be connected at this point). Connect any Vertex Standard microphone to the **MIC** jack, and place the **BASE/REPEATER** switch in the "**BASE**" position. Select Channel 1 for alignment purposes.
2. Press and hold in the **ACCESSORY** switch for two seconds to enter the adjustment mode. The channel number will begin to blink.
3. Press and hold in the **PTT** key on the microphone. The display will indicate "Po" while transmitting. Observe the power output as indicated on the wattmeter.
4. Press the ▲ (UP: increment) or ▼ (DOWN: decrement) button (to the right of the channel display) repeatedly to adjust the TX output power to 40 Watts (or less) while holding in the **PTT** key.
5. Once the desired power level has been obtained, release the **PTT** key. Now press and hold in the **ACCESSORY** button for at least two seconds to save the new setting and exit to the normal operation.
6. Repeat steps 2. through 5. (above) for any other channels (2 through 16) if they are to be used.
7. Re-test each channel in the normal operating mode to confirm the proper power output. You may now disconnect all test equipment.
8. The duplexer may now be installed.

The above procedure should only be performed by your Authorized Vertex Standard Dealer or a qualified radio technician, in order to ensure accurate calibration. Please consult with your Authorized Vertex Standard Dealer for assistance with procurement of a suitable duplexer.

Installations

1. Remove the 14 screws affixing the top and bottom covers of repeater, and remove the covers (Figure 1).
2. Turn the repeater upside down.
3. Referring to Figure 2, remove the upper screw in either side of the front panel, and loosen the lower screw in either side of the front panel, then slide the front panel forward slightly.
4. Remove the coaxial cables connected to the TX and RX antenna jacks of the repeater.
5. Mount the duplexer to the bottom side of the repeater, using the four screws supplied with the optional Antenna Cable **CT-68** (Figure 3).
6. Connect the optional Antenna Cable **CT-68** between the TX antenna jack of the repeater and ANT (center) jack of the duplexer.

7. If your repeater's Tx/Rx frequency relationship is "upper shift" type ($TXf > RXf$), connect the coaxial cable from the RX Unit to the LOW PASS jack of the duplexer and connect the coaxial cable from the PA Unit to the HIGH PASS jack of the duplexer.
If your repeater's Tx/Rx frequency relationship is "lower shift" type ($TXf < RXf$), connect the coaxial cable from the RX Unit to the HIGH PASS jack of the duplexer and connect the coaxial cable from the PA Unit to the LOW PASS jack of the duplexer.
Note: Route the TX coaxial cable from the PA Unit as far as possible from the RX coaxial cable from the RX Unit.
8. Duplexer installation is now complete. Replace the front panel back into place, and replace the top and bottom covers.

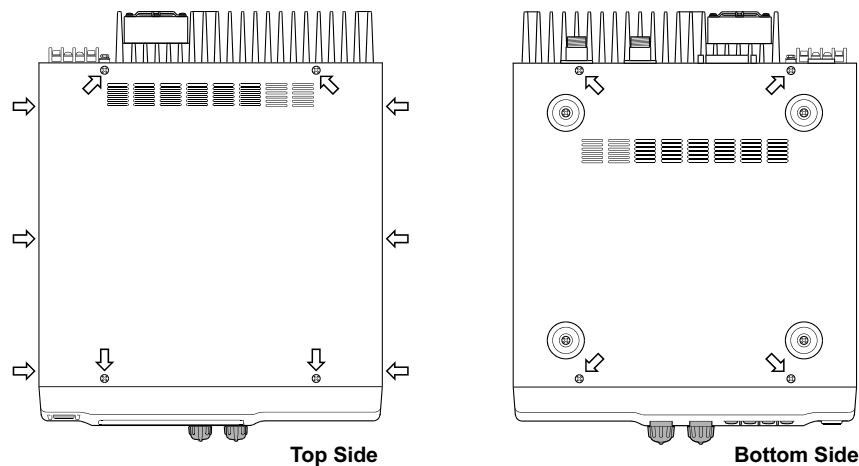

Figure 1

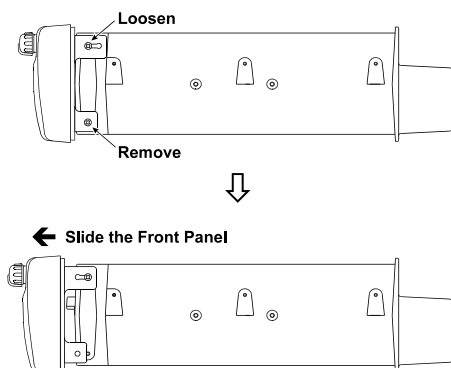

Figure 2

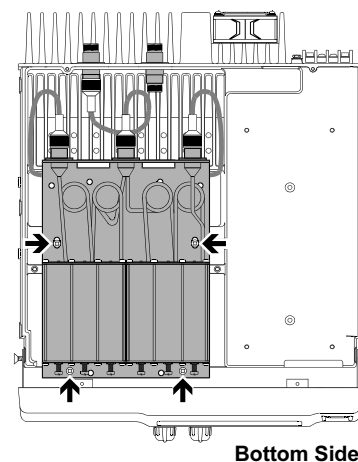

Figure 3

Specifications

General

Frequency Range:	136 ~ 150 MHz (A) or 150 ~ 174 MHz (C)
Number of Channels:	16
Channel Spacing:	12.5/25 kHz
Frequency Stability:	±2.5 ppm
Antenna Impedance:	50 Ω (N-Type)
Tx Activation System:	Carrier-operated, CTCSS tone operated, DCS operated, or remote control
Power Requirements:	115/230 V AC ±10%, 50/60 Hz or 13.8 VDC
Ambient Temperature Range:	-30 °C ~ +60 °C
Dimensions (w/o knobs):	325 x 115 x 391.5 mm (12.8 x 4.5 x 15.4 inches)
Weight (approx.):	10 kg (22 lbs.)

Receiver

Receiver Type:	Double-conversion Superheterodyne
Sensitivity:	0.35 μV for 12 dB SINAD, 0.45 μV for 20 dB NQ
Selectivity:	75 dB
Intermodulation:	75 dB
Spurious & Image Rejection:	80 dB
Audio Output:	4 W @ 4 Ω

Transmitter

RF Output:	10 ~ 50 W (Adjustable)
Duty Cycle:	100 %
Maximum Deviation:	±5.0 kHz (25 kHz spacing), ±2.5 kHz (12.5 kHz spacing)
Modulation Type:	16K0F3E/11K0F3E
Audio Distortion:	Less than 2.5 % @ 1 kHz
Spurious Emissions:	Better than 75 dB below carrier

Specifications are subject to change without notice.

Exploded View & Miscellaneous Parts

Ref.	YAESU P/N	Description	Qty.
①	U04308001	SEMS SCREW HSM3×8	5
②	U30312012	FLAT HEAD SCREW M3×12BSNI	1
③	U04408001	SEMS SCREW HSM4×8	4
④	U30306012	FLAT HEAD SCREW M3×6BSNI	9
⑤	U30314012	FLAT HEAD SCREW M3×14BSNI	5
⑥	U30308012	FLAT HEAD SCREW M3×8BSNI	2
⑪	U04306002	SEMS SCREW HSM3×6NI	12

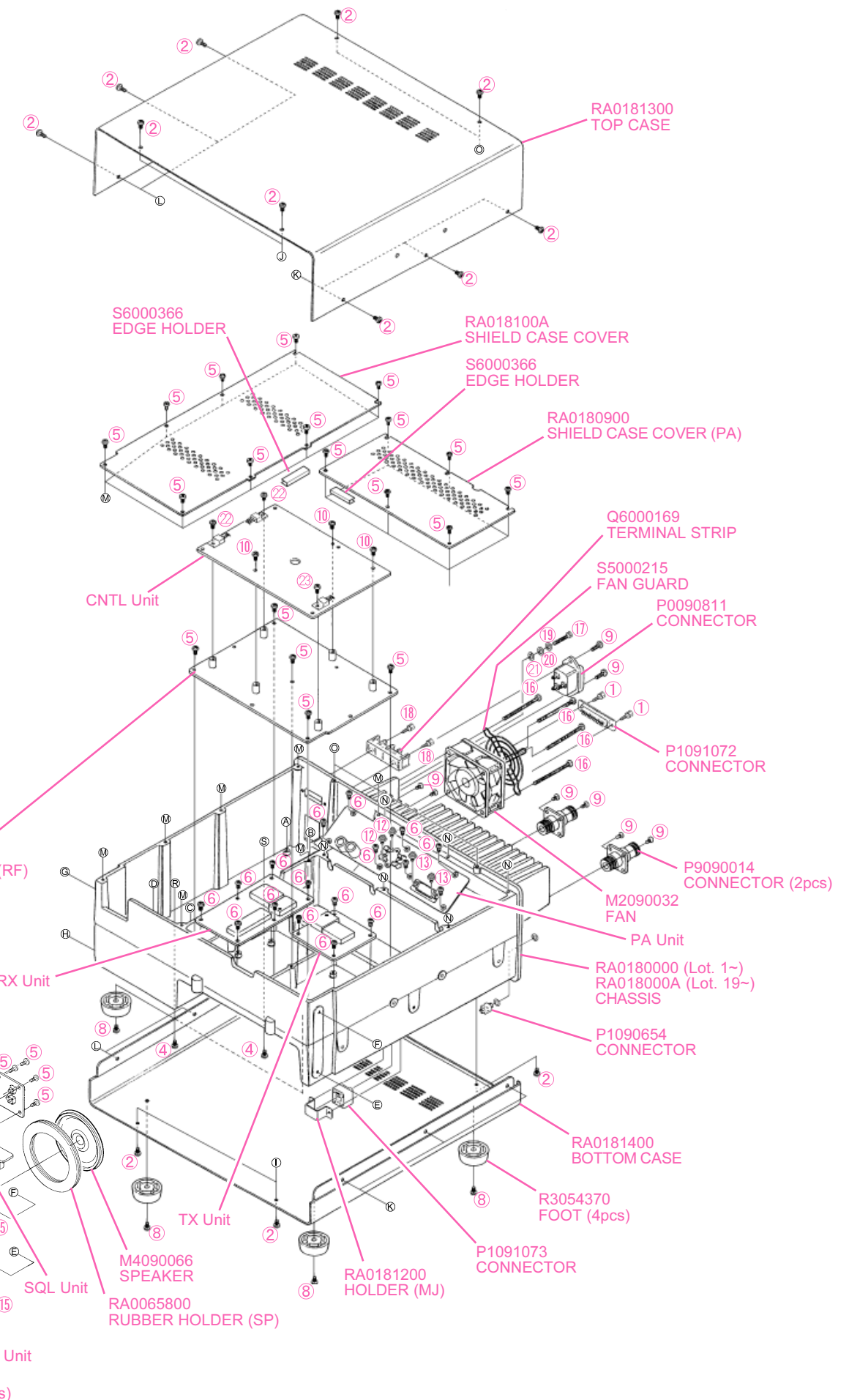
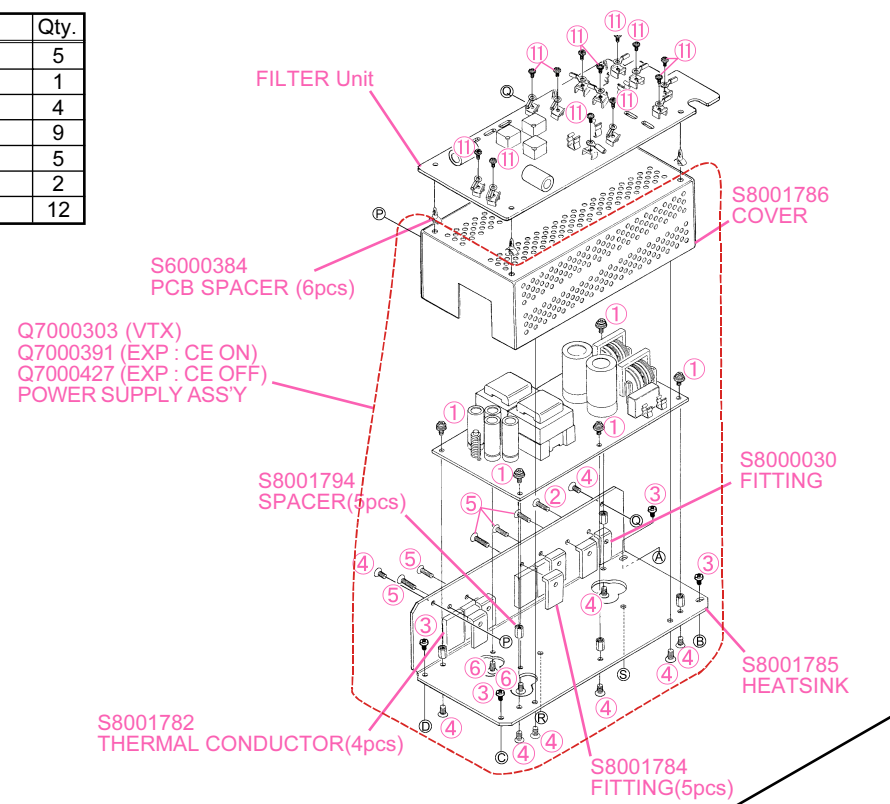

Ref.	VXSTD P/N	Description	Qty.
①	S5000182	SCREW JFS-4S-B1WM	2
②	U10306007	TRUSS HEAD SCREW M3×6B	14
③	U04408001	SEMS SCREW HSM4×8	4
④	U04308001	SEMS SCREW HSM3×8	2
⑤	U24306001	TAPTITE SCREW M3×6	34
⑥	U24308001	TAPTITE SCREW M3×8	18
⑦	U23308001	TAPTITE SCREW M3×8	1
⑧	U20406007	BINDING HEAD SCREW M4×6B	4
⑨	U20308002	BINDING HEAD SCREW M3×8NI	8
⑩	U20306001	BINDING HEAD SCREW M3×6	6
⑪	U04306002	SEMS SCREW HSM3×6NI	12
⑫	U02308002	SEMS SCREW SM3×8NI	2
⑬	U02206002	SEMS SCREW SM2.6×6NI	2
⑭	U00206002	PAN HEAD SCREW M2.6X6NI (Lot. 3-)	2
⑮	U00305001	PAN HEAD SCREW M3×5	2
⑯	U30308001	FLAT HEAD SCREW M3×8	4
⑰	U01330007	SEMS SCREW HSM3×30B	4
⑱	U04335007	SEMS SCREW HSM3×35B (Lot. 17-)	4
⑲	U52408002	HEX HEAD BOLT M4×8NI	1
⑳	U51416007	HEX SOCKET BOLT M4×16B	2
㉑	U70004002	PLAIN WASHER FW4NI	1
㉒	U71004002	SPRING LOCK WASHER SW4NI	1
㉓	U72004002	TOOTHED LOCK WASHER OW4NI	1
㉔	U20308001	BINDING HEAD SCREW M3×8	3

Non-designated parts are available only as part of a designated assembly.

Exploded View & Miscellaneous Parts

Note:

Exploded View & Miscellaneous Parts (Lot.92-)

Ref.	VTX P/N	Description	Qty.
①	U04308001	SEMS SCREW HSM3×8	5
②	U30312012	FLAT HEAD SCREW M3×12BSNI	1
③	U04408001	SEMS SCREW HSM4×8	4
④	U30306012	FLAT HEAD SCREW M3×6BSNI	9
⑤	U30314012	FLAT HEAD SCREW M3×14BSNI	5
⑥	U30308012	FLAT HEAD SCREW M3×8BSNI	2
⑪	U04306002	SEMS SCREW HSM3×6NI	12

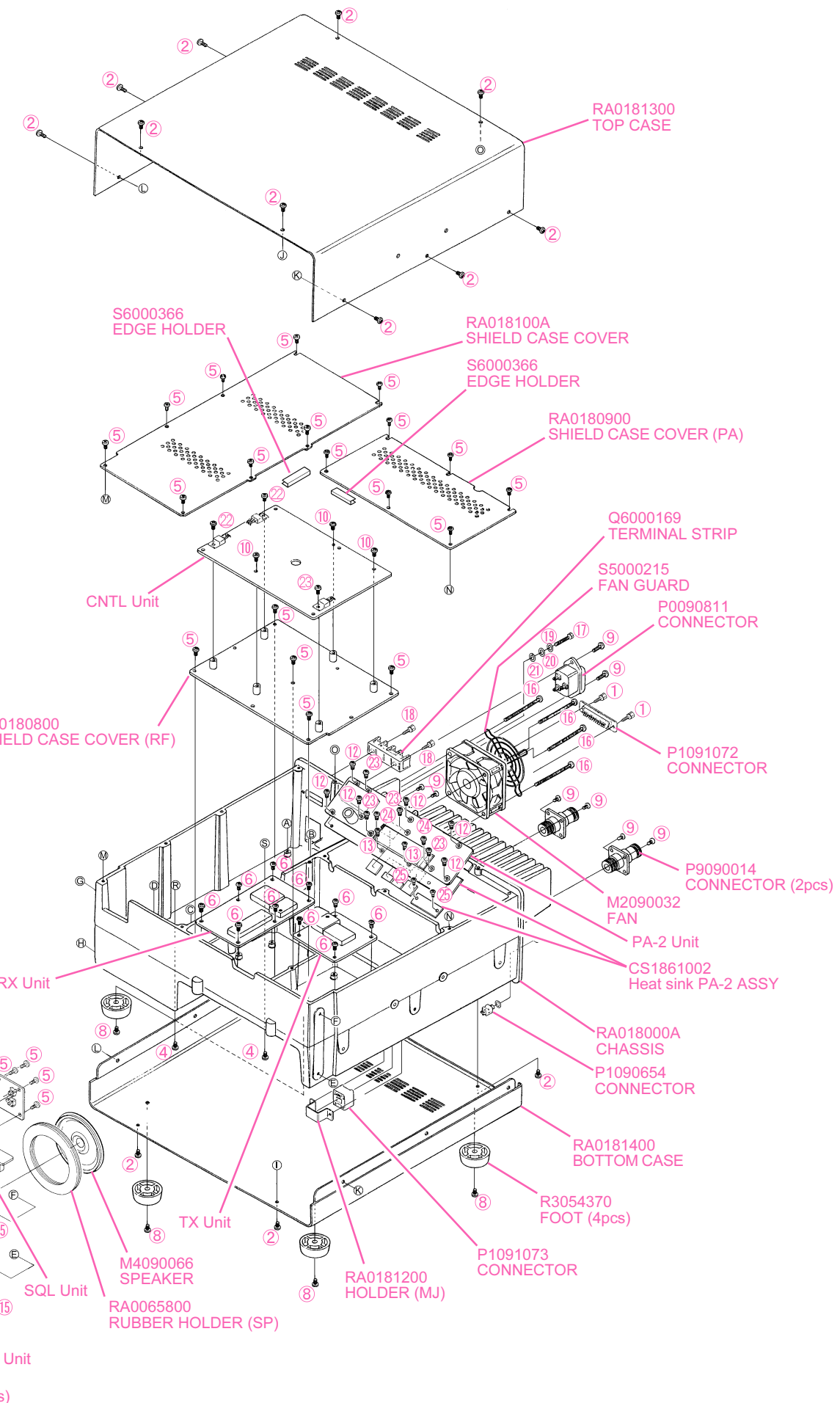
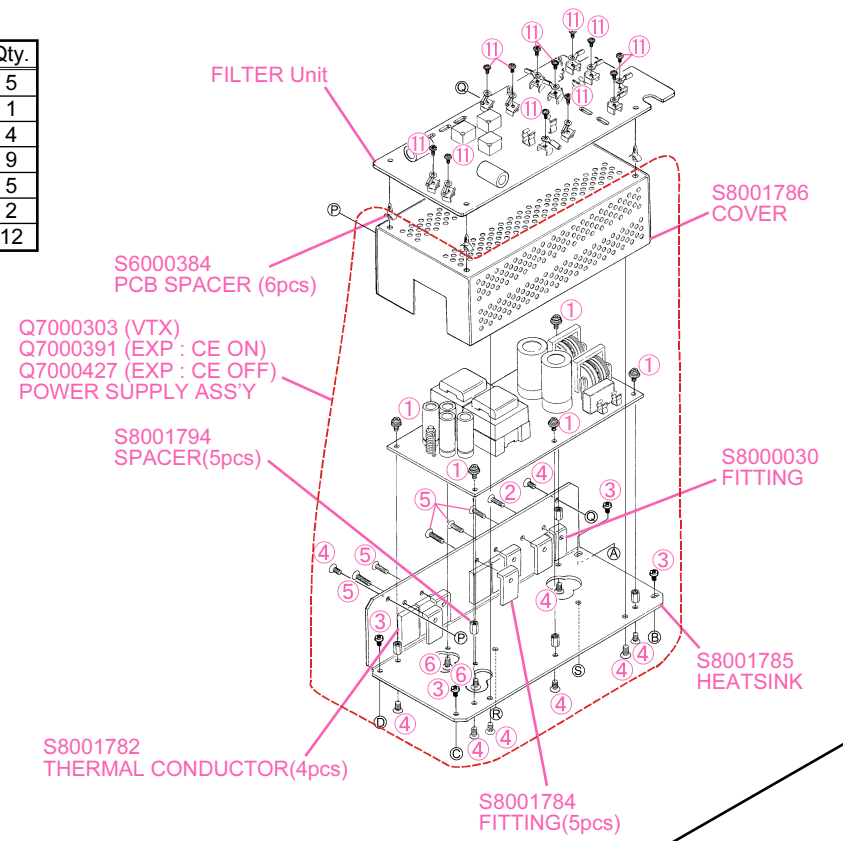

Ref.	VXSTD P/N	Description	Qty.
①	S5000182	SCREW JFS-4S-B1WM	2
②	U10306007	TRUSS HEAD SCREW M3×6B	14
③	U04408001	SEMS SCREW HSM4×8	4
④	U04308001	SEMS SCREW HSM3×8	2
⑤	U24306001	TAPTITE SCREW M3×6	34
⑥	U24308001	TAPTITE SCREW M3×8	13
⑦	U23308001	TAPTITE SCREW M3×8	1
⑧	U20406007	BINDING HEAD SCREW M4×6B	4
⑨	U20308002	BINDING HEAD SCREW M3×8NI	8
⑩	U20306001	BINDING HEAD SCREW M3×6	6
⑪	U04306002	SEMS SCREW HSM3×6NI	12
⑫	U24310001	TAPTITE SCREW M3×10	6
⑬	U34306001	TAPTITE SCREW M3X6	2
⑭	U00305001	PAN HEAD SCREW M3×5	2
⑮	U30308001	FLAT HEAD SCREW M3×8	4
⑯	U04335007	SEMS SCREW HSM3×35B	4
⑰	U52408002	HEX HEAD BOLT M4×8NI	1
⑱	U51416007	HEX SOCKET BOLT M4×16B	2
⑲	U70004002	PLAIN WASHER FW4NI	1
⑳	U71004002	SPRING LOCK WASHER SW4NI	1
㉑	U72004002	TOOTHED LOCK WASHER OW4NI	1
㉒	U20308001	BINDING HEAD SCREW M3×8	3
㉓	U20304001	BINDING HEAD SCREW M3×4	7
㉔	U20305001	BINDING HEAD SCREW M3X5	2
㉕	U32450001	FLAT HEAD SCREW M2.6X5	2

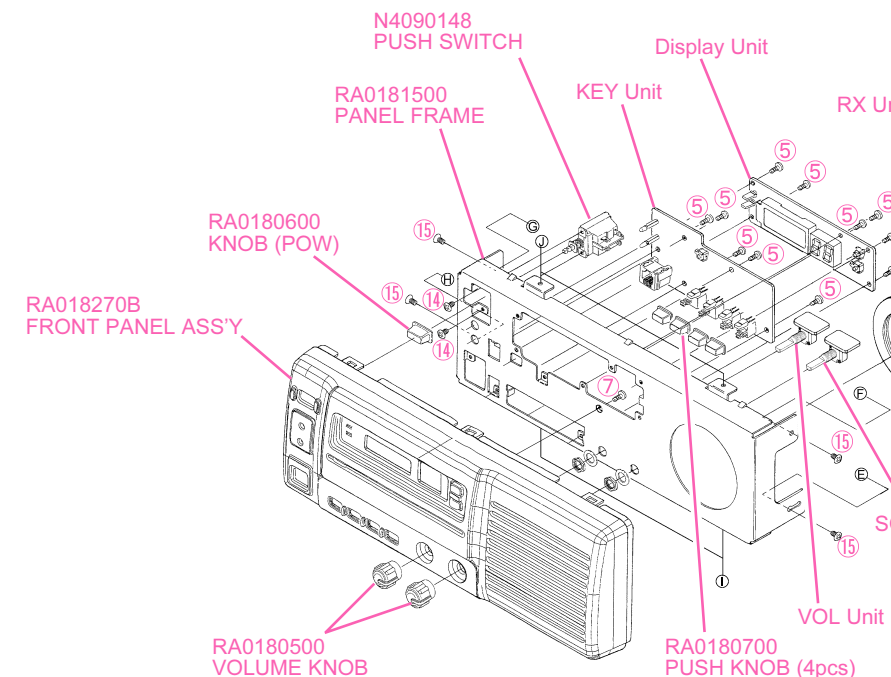

Non-designated parts are available only as part of a designated assembly.

Exploded View & Miscellaneous Parts (Lot.92-)

Heat sink PA-2 ASSY (vxstd p/n: CS1861002)

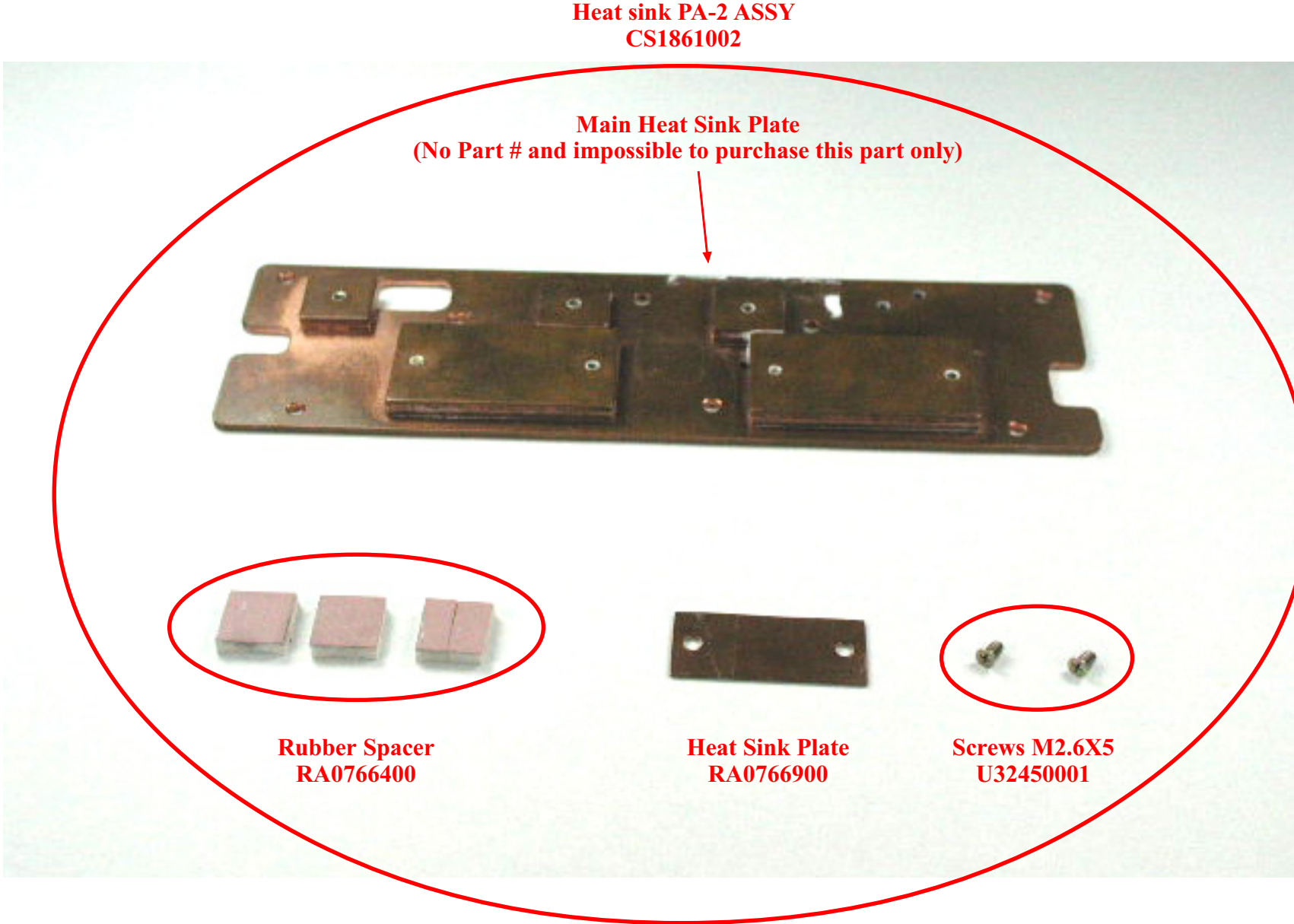

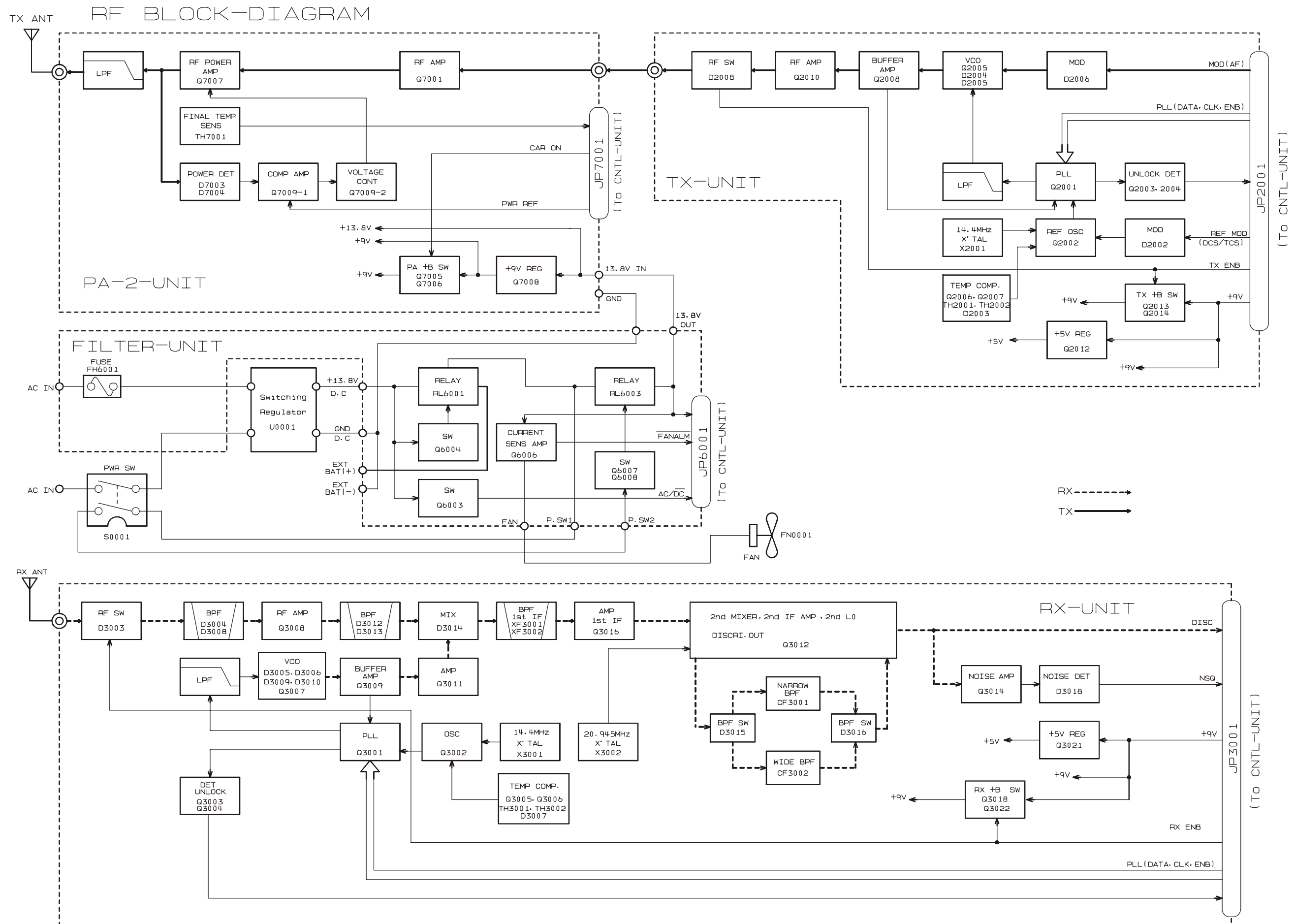

Block Diagram

CNTL BLOCK-DIAGRAM

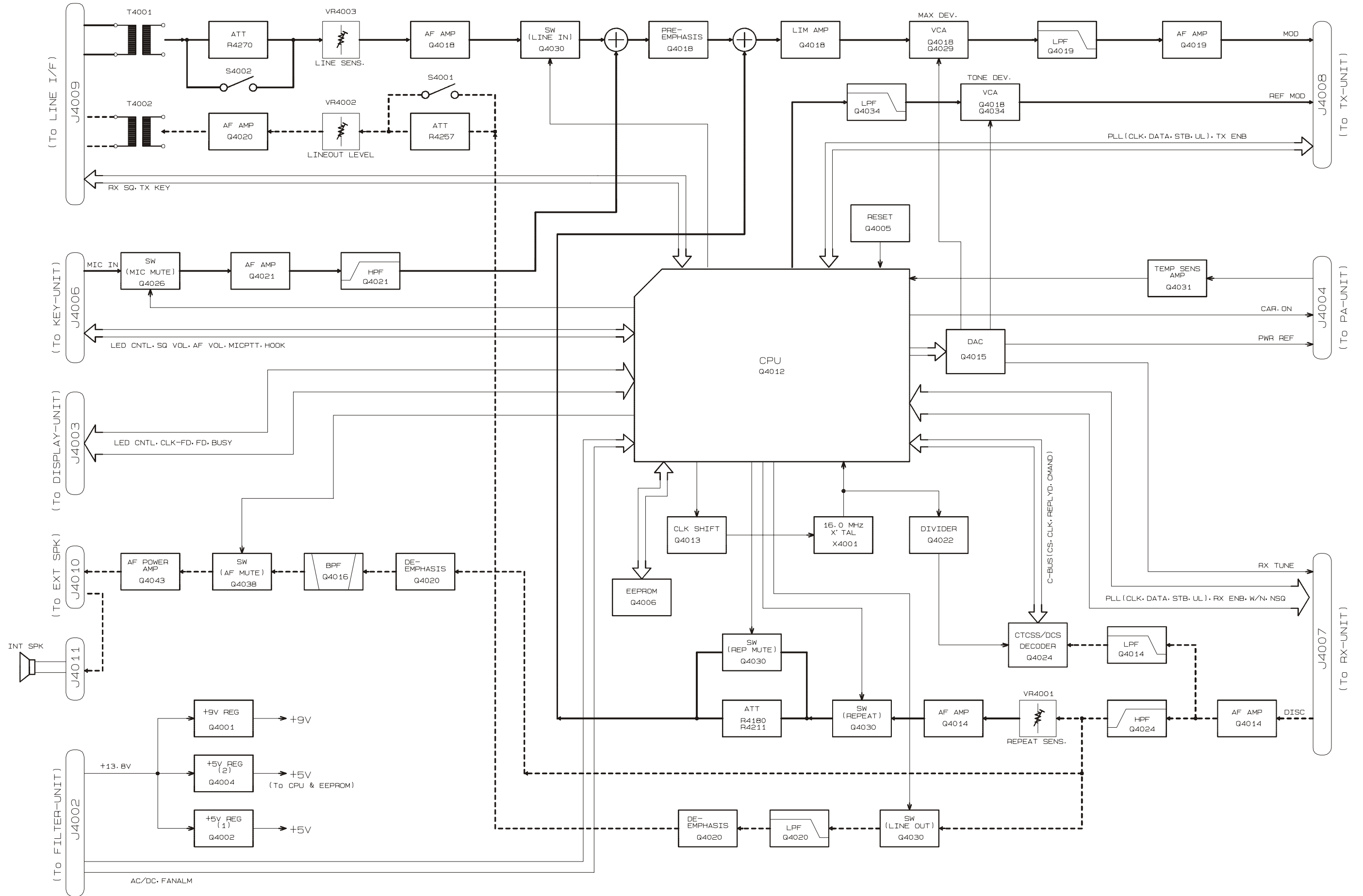

PANEL BLOCK-DIAGRAM

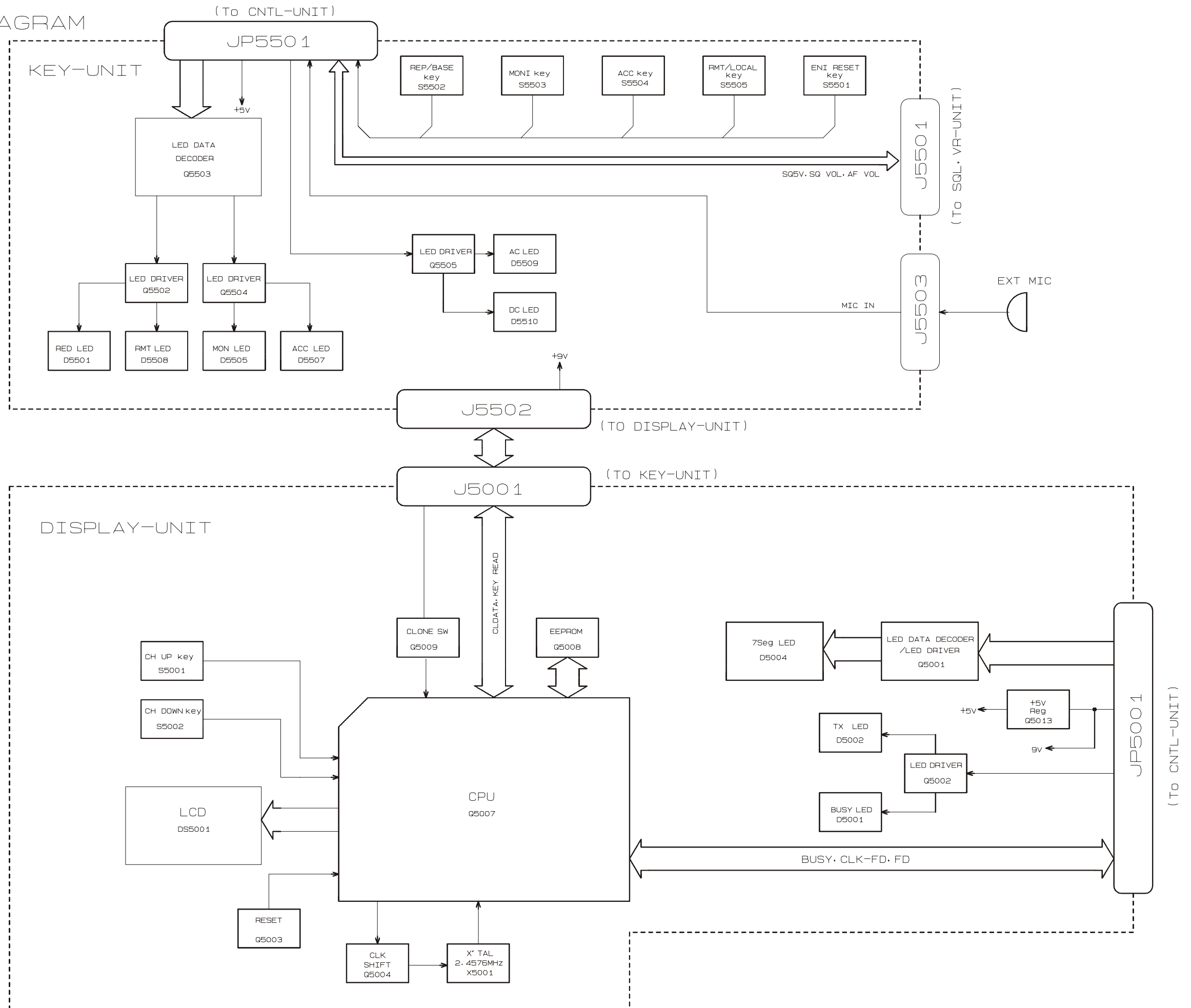

Interconnection Diagram

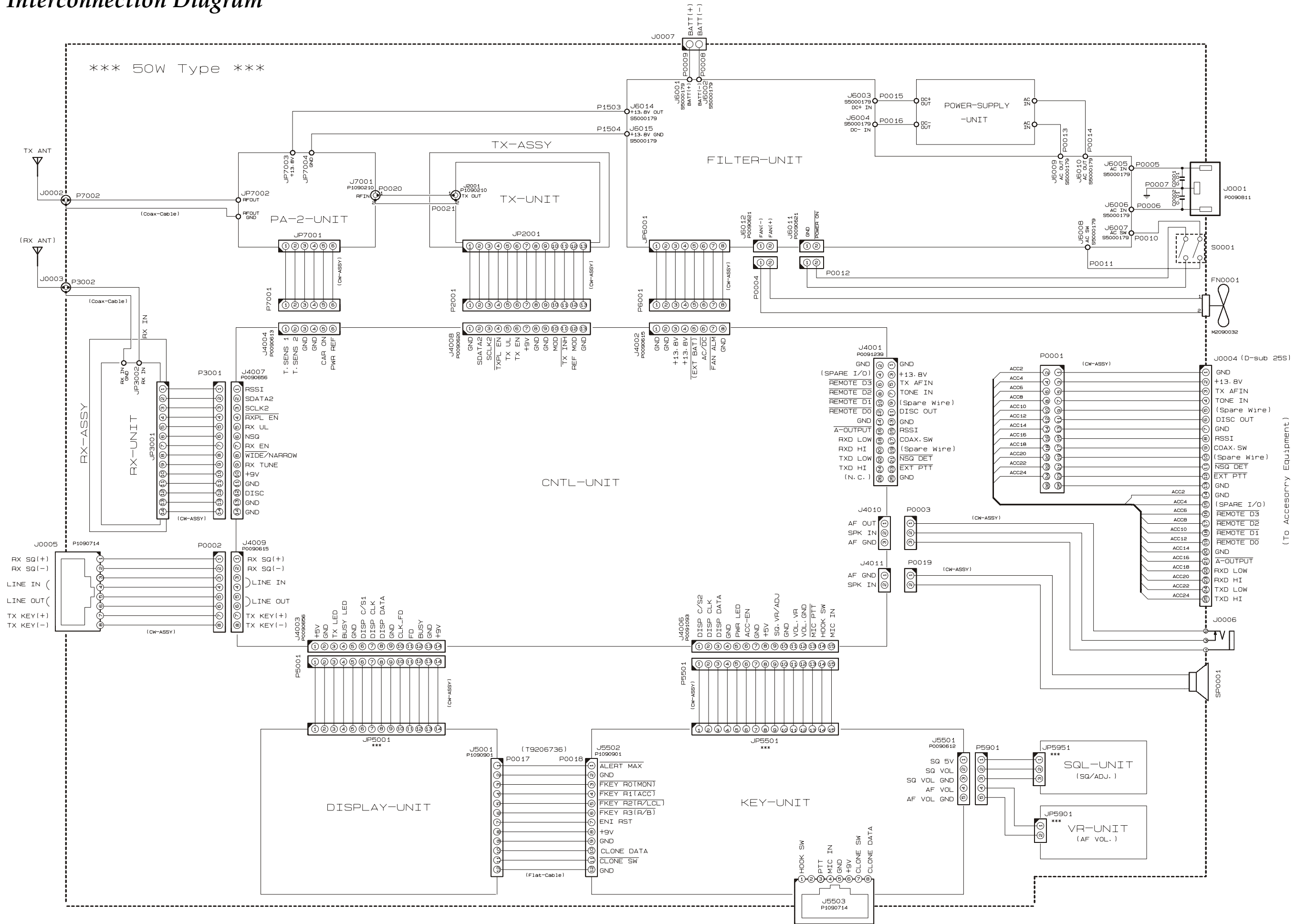

Circuit Description

Receive Signal Path

Incoming RF from the RX antenna jack is delivered to the RX Unit and passes through the protection diode **D3001 (MA143)** and a varactor-tuned band pass filter consisting of coils L3002 and L3004, capacitors C3019, C3021, C3024, C3027, and C3028, and diodes **D3004** and **D3008** (both **HVU350**). Signals are then applied to the RF amplifier, **Q3008 (2SC3357)**. The amplified RF signal is applied through a varactor-tuned band pass filter consisting of coils L3009 and L3012, capacitors C3053, C3054, C3059, C3060, and C3065, and diodes **D3012** and **D3013** (both **HVU350**) to the first mixer **D3014 (GN2011-Q)** along with the first local signal from the PLL circuit.

The first local signal is generated between 114.6 MHz and 152.6 MHz by the RX VCO, which consists of FET **Q3007 (2SK508)** and varactor diodes **D3005**, **D3006**, **D3009**, and **D3010 (HVU350)** according to the programmed receiving frequency; the local signal then passes through buffer amplifier **Q3009 (2SC5226)** and first local amplifier **Q3011 (2SC3357)** to the first mixer **D3014**.

The 21.4 MHz first IF signal is applied to monolithic crystal filters **XF3001** and **XF3002** (both **21M10B1**: ± 10 kHz B.W.) which strip away unwanted mixer products, and the IF signal is applied to the first IF amplifier **Q3016 (2SC2620QB)**. The amplified first IF signal is then delivered to the FM IF subsystem IC **Q3012 (TA31136FN)**, which contains the second mixer, second local oscillator, limiter amplifier, noise amplifier, and FM detector.

The second local oscillator signal, generated by the 20.945 MHz crystal **X3002**, produces the 455 kHz second IF signal when mixed with the first IF signal within **Q3021**. The second IF signal passes through ceramic filter **CF3001 (CFWM455G**: ± 4.5 kHz B.W.) or **CF3002 (CFWM455F**: ± 6.0 kHz B.W.) which strips away all but the desired signal, and then passes through the limiter amplifier within **Q3021** to ceramic discriminator **CD3001 (CDB455C7)**, which removes any amplitude variations in the 455 kHz IF signal before detection of speech. The detected audio passes through the low pass filter, consisting of R3067 and C3115, which rejects the 455 kHz IF component, then delivers the audio to pin 12 of JP3001.

The audio signal from the RX Unit is delivered to the CNTL Unit and passes through the audio amplifier **Q4014-3 (NJM2902M)** to the active high pass filter section of **Q4024 (FX-805)** which rejects the sub-audible frequency component. The filtered audio signal is delivered to potentiometer VR4001, which adjusts the audio sensitivity to compensate for audio level variations, then passes through audio amplifier **Q4014-2 (NJM2902M)**, audio switch **Q4030 (NJU4066BM)**, a 20 dB attenuator consisting of R4180 and R4211, and limiter amplifier **Q4018-2 (NJM2902M)**, to the electronic volume control **Q4029 (M51132FP)**, where the maximum deviation is set. The audio signal subsequently passes through the a 3-section active low pass filter consisting of **Q4019-1/-2/-3 (NJM2902M)** and

audio amplifier **Q4019-4** to J4008's pin 10, providing the repeater transmit audio.

A portion of the audio signal from the active high pass filter section of **Q4024** is de-emphasized by **Q4020-1 (NJM2902M)**, providing a flat audio response. The filtered audio then passes through the active band pass filter **Q4016 (NJM2902M)** and audio mute gate **Q4038 (DTC323TK)** to audio power amplifier **Q4043 (TDA2003H)**, providing up to 2 Watts of audio power to the 8 Ω loudspeaker.

Sub-Audible Signaling (Decoder)

A portion of the audio signal from the audio amplifier **Q4014-1** passes through the active low pass filter at **Q4014-2** and the low pass filtering section of **Q4024** to separate the sub-audible tones from the received audio signal. The sub-audible tones are sent to the CTCSS/DCS decoder section of **Q4024**. When a CTCSS tone or DCS code is received, the CTCSS or DCS information is delivered to pin 20 of the Main CPU **Q4012** from pin 4 of **Q4024**, which compares the CTCSS tone or DCS code with the programmed tone or code data. If the received CTCSS tone or DCS code matches the programmed tone or code, pin 39 of the Main CPU **Q4012** goes low, turning on the squelch switch **Q4036 (DTC323TK)** and passing the received audio signal to the audio power amplifier, **Q4043**.

Squelch Control

The squelch circuit consists of noise amplifier **Q3014 (2SC4116)** and noise detector **D3018 (MA143)** on the RX Unit, and control circuitry within main microprocessor **Q4012** on the CNTL Unit.

When no carrier is received, noise at the output of the audio detector stage of **Q3012** is amplified by **Q3014 (2SC4116GR)**, and then rectified by **D3018 (MA143)** to provide a DC control voltage for the squelch switch. The resulting DC voltage is delivered to pin 6 of JP3001.

The DC voltage from the RX Unit is delivered to the A-D analog input port (pin 31) of the Main CPU **Q4012 (HD64F3337YF16)** on the CNTL Unit, which compares the squelch threshold level to that which is memorized in EEPROM **Q4008 (NM93C86A)** or set by the front panel **SQL** control.

RX PLL and VCO Circuits

The receiver's PLL circuitry consists of PLL subsystem IC **Q3001 (MB15A02PFV1)** on the RX Unit, which contains a reference oscillator/divider, serial-to-parallel data latch, programmable divider, phase comparator and a swallow counter. Stability is obtained by a regulated 5 VDC supply via **Q3021 (TA78L05)** and the temperature-compensated temperature compensated 14.4 MHz crystal oscillator **X3001** via thermistor **TH3001** and **TH3002**.

The RX VCO, consisting of FET **Q3007** and varactor diodes **D3005**, **D3006**, **D3009**, and **D3010**, oscillates between 114.6 MHz and 152.6 MHz according to the programmed re-

Circuit Description

ceiving frequency. The RX VCO output passes through buffer amplifier **Q3009** and first local amplifier **Q3011** to the first mixer **D3014**, as described previously. A portion of the RX VCO output is applied to the prescaler/swallow counter section in the PLL IC, **Q3001**. There the RX VCO signal is divided by 64 or 65, according to a control signal from the Main CPU **Q4012** on the CNTL Unit, before being applied to the programmable divider section of the PLL IC **Q3001**.

The data latch section of the PLL IC **Q3001** also receives serial dividing data from the Main CPU **Q4012**, which causes the pre-divided RX VCO signal to be further divided by 22,920 ~ 30,520 in the programmable divider section in the PLL IC **Q3001**, depending upon the desired receive frequency, so as to produce a 5 kHz or 6.25 kHz derivative of the current RX VCO frequency. Meanwhile, the reference divider section of the PLL IC **Q3001** divides the 14.4 MHz crystal reference from the reference oscillator **X3001** and **Q3002 (2SC4116GR)** by 2880 (or 2304) to produce the 5 kHz (or 6.25 kHz) loop reference.

The 5 kHz or 6.25 kHz signal from the programmable divider (derived from the RX VCO) and that derived from the crystal are applied to the phase detector section of the PLL IC **Q3001**, which produces a pulsed output with pulse duration depending on the phase difference between the input signals. This pulse train is then converted to DC, low pass filtered, then fed back to the RX VCO varactor diodes **D3005**, **D3006**, **D3009**, and **D3010**.

Changes in the DC voltage applied to the varactor diodes **D3005**, **D3006**, **D3009**, and **D3010** affect the reactance in the tank circuit RX VCO **Q3007**, changing the oscillating frequency according to the phase difference between the signals derived from the RX VCO and the crystal reference oscillator. The RX VCO is thus phase-locked to the reference frequency standard.

Transmit Signal Path

The TX VCO, consisting of FET **Q2005 (2SK508)** and varactor diodes **D2004** and **D2005**, oscillates between 136 MHz and 174 MHz according to the programmed transmit frequency. The theory of operation of the remainder of the PLL circuitry is similar to that of the RX PLL circuit; however, dividing data from the Main CPU **Q4012** on the CNTL Unit is such that the VCO frequency is the actual transmit frequency.

The speech audio from the CNTL Unit is applied to varactor diode **D2005 (HVU350)**, which frequency modulates the TX VCO up to ± 5 kHz (wide band) or ± 2.5 kHz (narrow band) from the unmodulated carrier at the transmit frequency. The modulated transmit signal is buffered by **Q2008 (2SC5226)**, then passes through the RF amplifier **Q2010 (2SC3357)** and RF diode switch **D2008 (RN739F)** to the PA Unit.

The transmit signal is applied to the RF amplifier **Q1501 (2SC3357)** and RF power module IC **Q1502 (PF0310A)**, then

finally amplified by power amplifier **Q1507 (2SC5125)** up to 50 Watts. Harmonic and spurious radiation in the final output is suppressed by a low pass filter consisting of coils L1511 ~ L1515, plus capacitors C1546, C1547, C1554, C1556, C1560, and C1566 on the PA Unit, before delivery to the TX antenna jack.

APC (Automatic Power Control)

RF power output from the final amplifier **Q1507** is sampled by C1548/C1558 and is then rectified by **D1503/D1504 (both 1SS319)**. The resulting DC voltage is applied to the comparator **Q1509 (TA75S01F)**, where the voltage is compared with a reference voltage from the Main CPU **Q4012** on the CNTL Unit, to produce a control voltage for the Automatic Power Controller **Q1503 (2SB1122S)** and **Q1504 (2SC4116GR)**, which regulates supply voltage to the RF power module IC **Q1502**, so as to maintain stable high (or low) output power under varying antenna loading conditions.

CONTROL (CNTL) Unit

The CNTL Unit consists of 8-bit CPU **Q4012 (HD64F3337YF16)**, EEPROM **Q4008 (NM93C86A)**, RX and TX speech audio circuits, and various analog switches for the CPU and repeater interconnections.

Microprocessor operational code is stored in **Q4008**, while channel data and repeater configuration information is programmed from an external PC connected to the front panel's MIC jack via a VPL-1 programming cable.

The output from the Main CPU, **Q4012**, contains serial control data used for REPEATER/BASE mode control, as well as TX and RX PLL data. Crystal X4001 oscillates at 16 MHz, and provides stable clock timing for the Main CPU. When the repeater is powered on, the voltage at pin 8 of **Q4012** becomes stable, and the output of voltage detector IC **Q4005 (RH5VL45AA)**, which is tied to **Q4012** (pin 1-RST) becomes high, resetting the Main CPU.

Base Operation (Tx, Line-Input Audio)

Line input from J4009 (pins 3 and 4) is impedance matched by transformer T4001, then passes through the audio amplifier **Q4018 (NJM2902M)** and audio switch **Q4030 (NJU4066BM)** to the pre-emphasis network at **Q4018-1**, where the signal is processed in the same manner as previously described. The line level can be attenuated by switch S4002, and line sensitivity can be adjusted to -10 dBm ~ $+10$ dBm by potentiometer VR4003 to compensate for audio line level variations.

Base Operation (Tx, Mic-Input Audio)

Microphone input is delivered past the MIC MUTE switch **Q4026 (DTC323TK)**, then passes through the audio amplifier and active low pass filter at **Q4021 (NJM2902M)** to the pre-emphasis network at **Q4018-1**, where the signal is processed in the same manner as previously described.

The VXR-7000 is carefully aligned at the factory for the specified performance across the entire operating frequency range. Realignment should therefore not be necessary except in the event of a component failure. All component replacement and service should be performed only by an authorized Vertex Standard representative, or the warranty policy may be void.

The following procedures cover the sometimes critical and tedious adjustments that are not normally required once the repeater has left the factory. However, if damage occurs and some parts subsequently are placed, realignment may be required. If a sudden problem occurs during normal operation, it is likely due to component failure; realignment should not be done until after the faulty component has been replaced.

We recommend that servicing be performed only by authorized Vertex Standard service technicians who are experienced with the circuitry and fully equipped for repair and alignment. Therefore, if a fault is suspected, contact the dealer from whom the repeater was purchased for instructions regarding repair. Authorized Vertex Standard service technicians realign all circuits and make complete performance checks to ensure compliance with factory specifications after replacing any faulty components.

Those who do undertake any of the following alignments are cautioned to proceed at their own risk. Problems caused by unauthorized attempts at realignment are not covered by the warranty policy. Also, Vertex Standard reserves the right to change circuits and alignment procedures in the interest of improved performance, without notifying owners.

Under no circumstances should any alignment be attempted unless the normal function and operation of the repeater are clearly understood, the cause of the malfunction has been clearly pinpointed and any faulty components replaced, and realignment determined to be absolutely necessary.

The following test equipment (and thorough familiarity with its correct use) is necessary for complete realignment. Correction of problems caused by misalignment resulting from use of improper test equipment is not covered under the warranty policy. While most steps do not require all of the equipment listed, the interactions of some adjustments may require that more complex adjustments be performed afterwards.

Do not attempt to perform only a single step unless it is clearly isolated electrically from all other steps. Have all test equipment ready before beginning, and follow all of the steps in a section in the order presented.

Required Test Equipment

- RF Signal Generator with calibrated output level at 200 MHz
- Deviation Meter (linear detector)
- In-line Wattmeter with 5% accuracy at 200 MHz
- 50 Ω RF Dummy Load with power rating 100W at 200MHz
- 4 Ω AF Dummy Load
- Frequency Counter with 0.2 ppm accuracy at 200MHz
- AF Signal Generator
- AC Voltmeter
- DC Voltmeter: High input impedance
- VHF Sampling Coupler
- SINAD Meter
- IBM PC/compatible Computer with MS-DOS or later operating system
- Yaesu VPL-1 Connection Cable & CE27 Channel/Alignment Diskette

Alignment Preparation & Precautions

A 50 Ω RF Dummy Load and in-line wattmeter must be connected to the TX antenna jack in all procedures that call for transmission, except where specified otherwise. Correct alignment is not possible with an antenna.

After completing one step, read the following step to determine whether the same test equipment will be required. If not, remove the test equipment (except dummy load and wattmeter, in connected) before proceeding.

Correct alignment requires that the ambient temperature be the same as that of the repeater and test equipment, and that this temperature be held constant between 68° F ~ 86° F (20° C ~ 30° C). When the repeater is brought into the shop from hot or cold air, it should be allowed time to come to room temperature before alignment.

Whenever possible, alignments should be made with oscillator shields and circuit boards firmly affixed in place. Also, the test equipment must be thoroughly warmed up before beginning.

Note: Signal levels in dB referred to in the alignment procedure are based on $0 \text{ dB}\mu = 0.5 \mu\text{V}$ (closed circuit).

Alignment

Set up the test equipment as shown below, and apply AC power to the repeater.

The repeater must be programmed for use in the intended system before alignment is attempted. The frequency and other parameters are loaded from the file during the alignment process.

In order to facilitate alignment over the complete switching range of the equipment it is recommended that the channel data first be uploaded and then stored to disk. Channels at the upper, lower and middle band edges should then be downloaded. The original data can be replaced at the end of the alignment process.

Channel	Frequency (MHz)	
	TYP C	TYP A
Low band edge	150.000	136.000
Mid 1	160.000	140.000
Center	162.000	143.000
Mid 2	170.000	145.000
High band edge	174.000	150.000

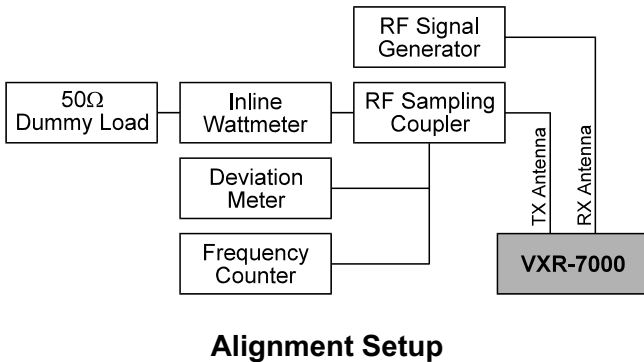

Transmitter

Press the **BASE/REPEATER** switch on the front panel of the repeater so as to set it to the “**BASE**” mode if the **REPEATER** LED is on. You should see the **REPEATER** LED turn off, indicating that the repeater is now in the “**BASE**” mode.

PLL VCV (Varactor Control Voltage) Check

- Connect the DC voltmeter between the VCV check point (on the TX Unit) and chassis ground.
- Select the Low band edge channel, then key the repeater. Confirm that the DC voltmeter reading is 1.7 V ~ 2.4 V (TYP C) or 1.6 V ~ 2.2 V (TYP A).
- Select the High band edge channel, then key the repeater. Confirm that the DC voltmeter reading is 3.9 V ~ 5.3 V (TYP C) or 3.0 V ~ 4.0 V (TYP A).

PLL Reference Frequency Adjustment

- Connect the Frequency counter to **J2001** on the TX Unit.
- Select the Center channel, then key the repeater.
- Adjust **TC2001** (on the TX unit), if necessary, so that the frequency counter reading is within ± 100 Hz of the programmed Center channel frequency.

Transmitter parameters (excluding PLL)

- The following transmitter parameters can be adjusted from the computer by utilizing the CE27 Channel/Alignment Diskette. Refer to the onboard help of the CE27 Channel/Alignment Diskette for details.

TX Parameters	Data
TX Power Level (High)	0 (00h) ~ 255 (FFh)
TX Power Level (Mid 1)	0 (00h) ~ 255 (FFh)
TX Power Level (Mid 2)	0 (00h) ~ 255 (FFh)
TX Power Level (Low)	0 (00h) ~ 255 (FFh)
Maximum Deviation	0 (00h) ~ 255 (FFh)
CTCSS Deviation	0 (00h) ~ 255 (FFh)
DCS Deviation	0 (00h) ~ 255 (FFh)

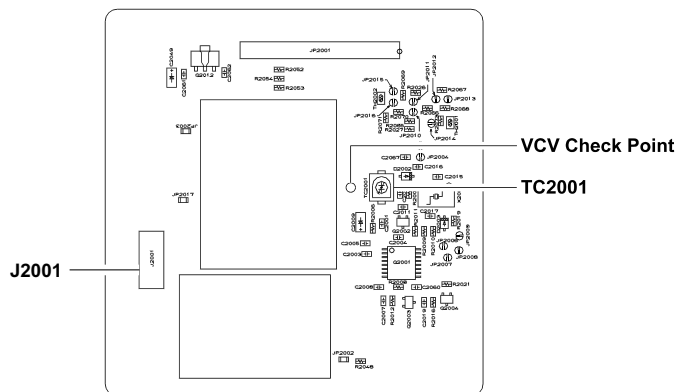

TX Unit Alignment Points

Receiver

PLL VCV (Varactor Control Voltage) Check

- ❑ Connect the DC voltmeter between the VCV check point (on the RX Unit) and chassis ground.
- ❑ Select the Low band edge channel, and confirm that the DC voltmeter reading is 0.9 V ~ 1.5 V (TYP C) or 1.6 V ~ 2.0 V (TYP A).
- ❑ Select the High band edge channel, and confirm that the DC voltmeter reading is 2.7 V ~ 4.0 V (TYP C) or 3.4 V ~ 4.0 V (TYP A).

PLL Reference Frequency Adjustment

- ❑ Connect the Frequency counter to **J3001** on the RX Unit.
- ❑ Select the Center channel, adjust **TC3001** (on the RX Unit), if necessary, so that the frequency counter reading is within ± 100 Hz of the programmed Center channel frequency.

Receiver parameters (excluding PLL)

- ❑ The following receiver parameters can be adjusted from the computer by utilizing the CE27 Channel/Alignment Diskette. Refer to the onboard help of the CE27 Channel/Alignment Diskette for details.

RX Parameters	Data
Squelch Threshold Level	0 (00h) ~ 255 (FFh)
Squelch W/N Level	0 (00h) ~ 255 (FFh)
RSSI Threshold Level	0 (00h) ~ 255 (FFh)
RX Tune Level	0 (00h) ~ 255 (FFh)

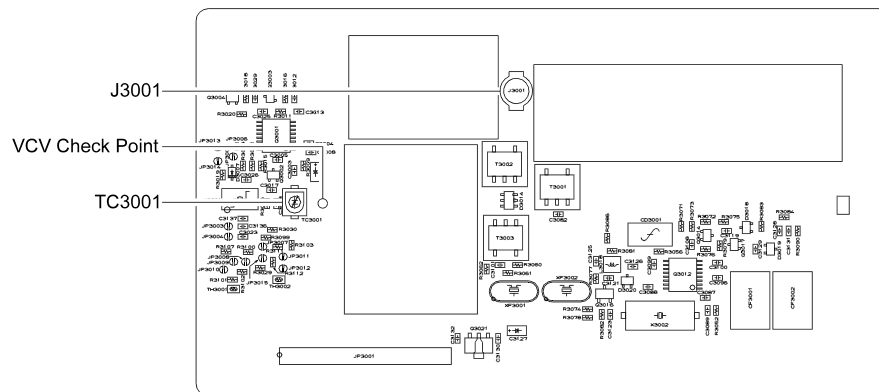

RX Unit Alignment Points

Alignment

Repeater Mode

Deviation Adjustment

- ❑ First ensure that the “**DUPLEX**” mode of operation is enabled via CE27 programming.
- ❑ Set the **BASE/REPEATER** switch on the front panel of the repeater to the “**REPEATER**” mode (the **REPEATER** LED will turn on).
- ❑ Inject a signal on the Center channel frequency at a level of 40 dB μ (1 kHz tone @ ± 3 kHz deviation) from the RF Signal Generator into the **RX** antenna jack, and adjust **VR4001** (on the CNTL Unit) so that the deviation meter reading (TX deviation) is ± 3.0 kHz (± 0.3 kHz) deviation.

Base Mode

Alignment Setup

- ❑ Set the **BASE/REPEATER** switch on the front panel of the repeater to the “**BASE**” mode (the **REPEATER** LED will turn off).
- ❑ Press the **LOCAL/REMOTE** switch on the front panel of the repeater to the “**REMOTE**” mode (the **REMOTE** LED will turn on).
- ❑ Set **S4001** and **S4002** (on the CNTL Unit) to the “**OFF**” position, then select the Center channel.

Audio Level Adjustment (LINE OUT Level)

- ❑ Inject a signal on the Center channel frequency at a level of 40 dB μ (1 kHz tone @ ± 3.5 kHz deviation) from the RF Signal Generator into the **RX** antenna jack, and adjust **VR4002** (on the CNTL Unit) so that the “Line Out” audio level (**LINE** jack pins 5 and 6) is -10 dBm (± 0.5 dBm).

Deviation Adjustment (LINE IN Level)

- ❑ Connect the AF generator to **LINE** jack pins 3 and 4, and the AF generator output level to -10 dBm, at a frequency of 1 kHz.
- ❑ Key the repeater, and adjust **VR4003** (on the CNTL Unit) so that the deviation meter reading (TX deviation) is 3.0 kHz (± 0.1 kHz) deviation.

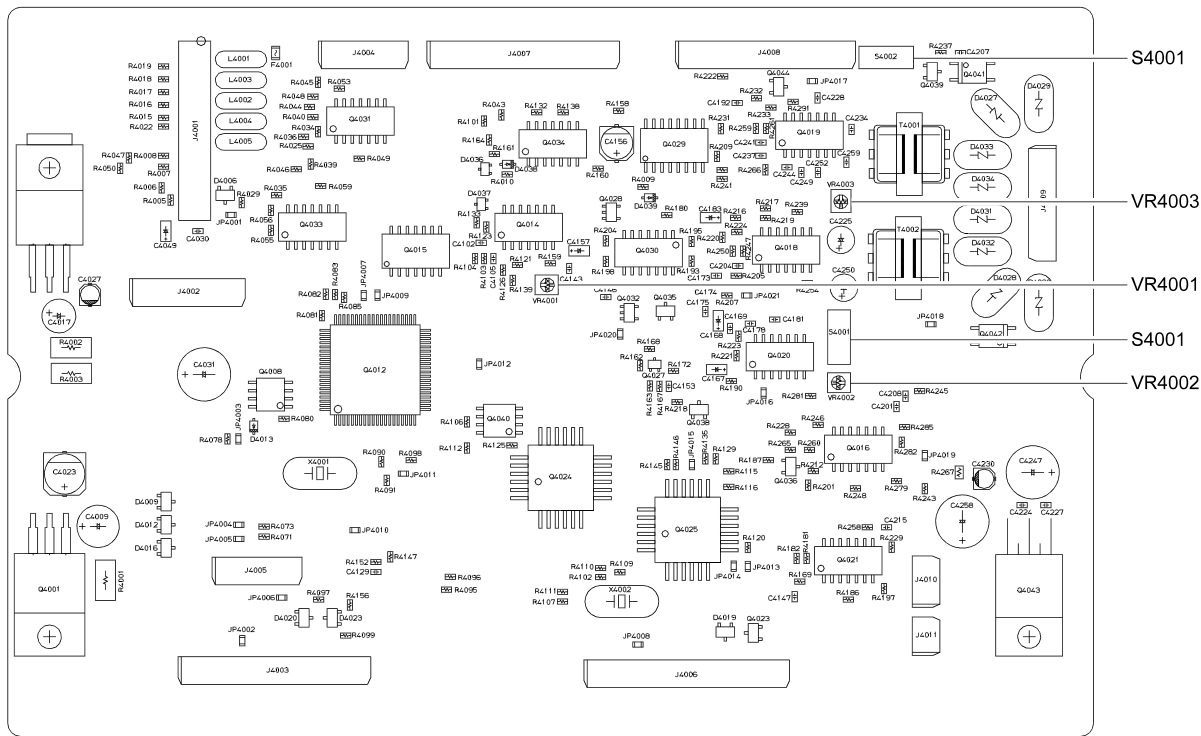

CNTL Unit Alignment Points

Circuit Diagram

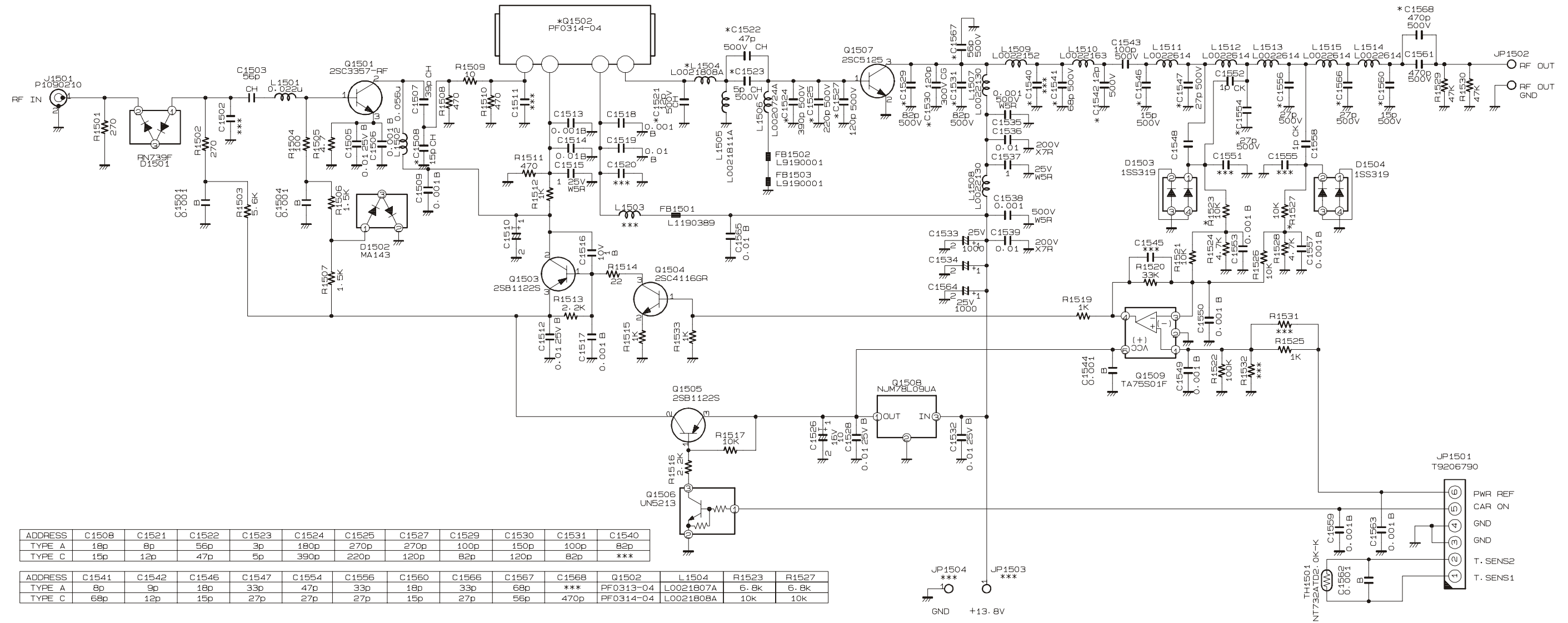

ADDRESS	C1508	C1521	C1522	C1523	C1524	C1525	C1527	C1529	C1530	C1531	C1540
TYPE A	18p	8p	56p	3p	180p	270p	270p	100p	150p	100p	82p
TYPE C	15p	12p	47p	5p	390p	220p	120p	82p	120p	82p	***

ADDRESS	C1541	C1542	C1546	C1547	C1554	C1556	C1560	C1566	C1567	C1568	Q1502	L1504	R1523	R1527
TYPE A	8p	9p	18p	33p	47p	33p	18p	33p	68p	***	PF0313-04	L0021807A	6.8k	6.8k
TYPE C	68p	12p	15p	27p	27p	27p	15p	27p	56p	470p	PF0314-04	L0021808A	10k	10k

PA Unit (Lot. 1~)

Parts Layout

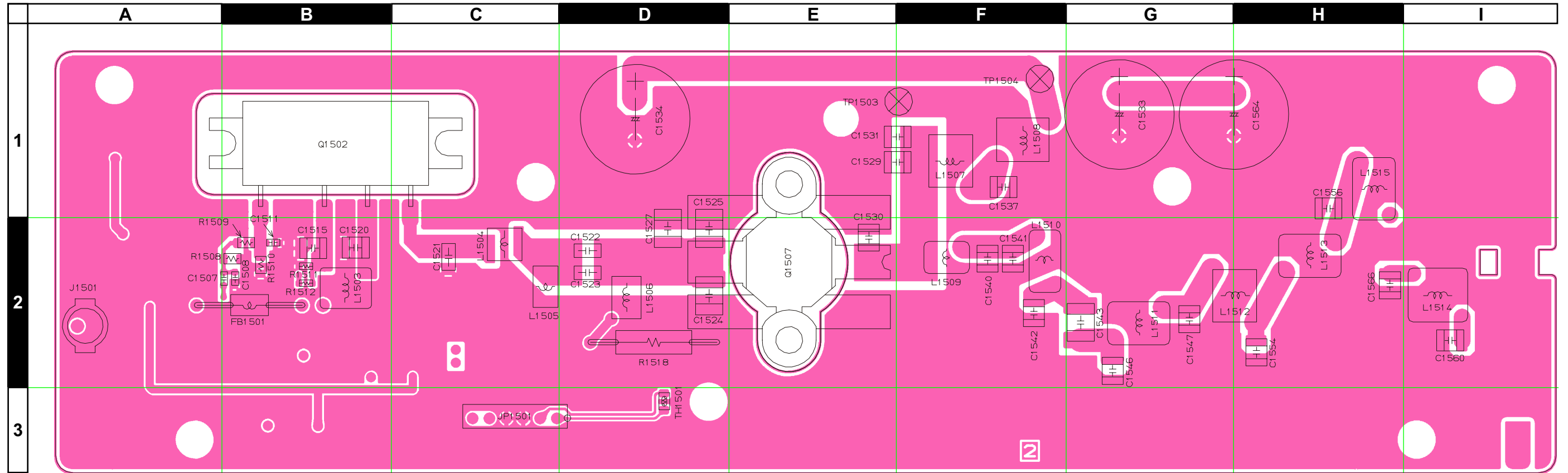

Side A

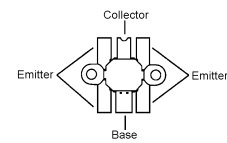

2SC5125
(Q1507)

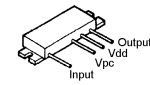

PF0314 (TYP C)
PF0313 (TYP A: Lot. 7~)
(Q1502)

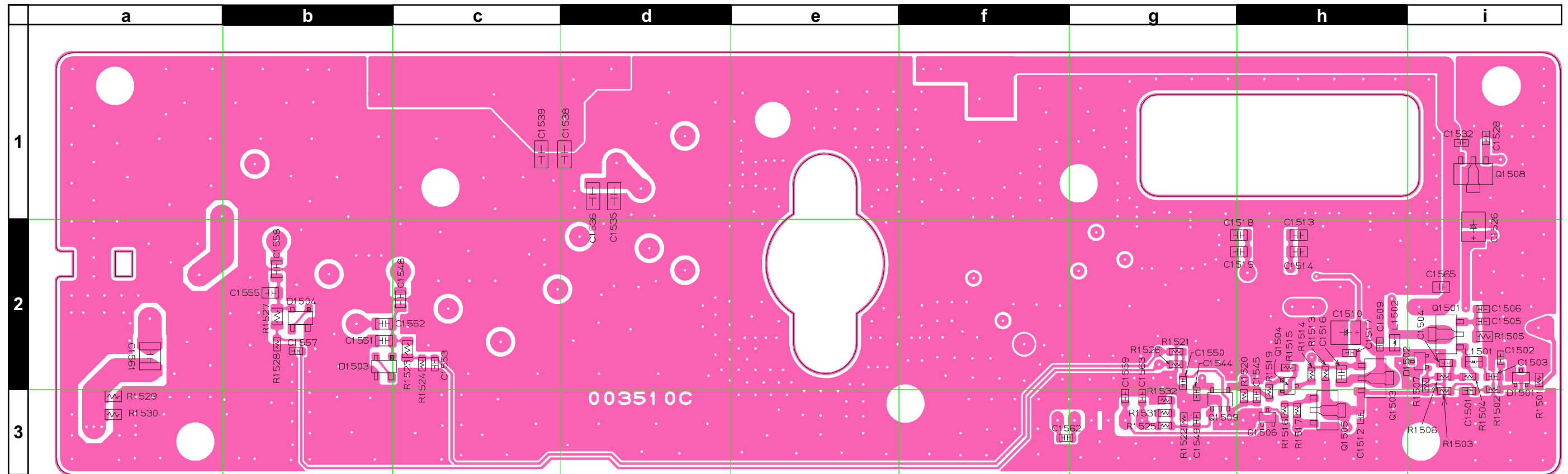

Side B

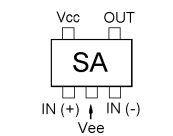

TA75S01F (SA)
(Q1509)

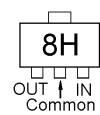

NJM78L09UA (8H)
(Q1508)

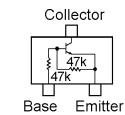

UN5213 (8C)
(Q1506)

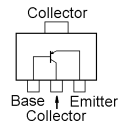

2SB1122S (BE)
(Q1503, 1505)

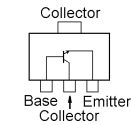

2SC3357 (RK)
(Q1501)

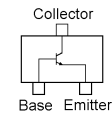

2SC4116GR (LG)
(Q1504)

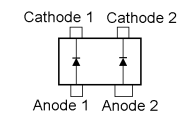

1SS319 (A4)
(D1503, 1504)

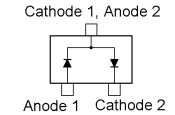

MA143 (MC)
(D1502)
RN739F (5F)
(D1501)

PA Unit

Note:

Parts List

REF.	DESCRIPTION	VALUE	V/W	TOL.	MFR'S DESIG	VXSTD P/N	VERS.	LOT.	SIDE	LAYADR
*** PA UNIT ***										
PCB with Components						CS1645051	VERSION C			
PCB with Components						CS1645052	VERSION A			
	Printed Circuit Board					FR003510C		1-91		
C 1501	CHIP CAP.	0.001uF	50V	B	GRM188B11H102KA01D	K22174821		1-	B	i3
C 1503	CHIP CAP.	56pF	50V	CH	GRM1882C1H560JA01D	K22174229		1-	B	i2
C 1504	CHIP CAP.	0.001uF	50V	B	GRM188B11H102KA01D	K22174821		1-	B	i2
C 1505	CHIP CAP.	0.01uF	25V	B	GRM39B103M25PT	K22144802		1-	B	i2
C 1506	CHIP CAP.	0.001uF	50V	B	GRM188B11H102KA01D	K22174821		1-	B	i2
C 1507	CHIP CAP.	39pF	50V	CH	GRM1882C1H390JA01D	K22174225		1-	A	A2
C 1508	CHIP CAP.	15pF	50V	CH	GRM1882C1H150JA01D	K22174215		1-6	A	B2
C 1508	CHIP CAP.	18pF	50V	CH	GRM1882C1H180JA01D	K22174217	VERSION A	7-	A	B2
C 1508	CHIP CAP.	15pF	50V	CH	GRM1882C1H150JA01D	K22174215	VERSION C	7-	A	B2
C 1509	CHIP CAP.	0.001uF	50V	B	GRM188B11H102KA01D	K22174821		1-	B	h2
C 1510	CHIP TA.CAP.	10uF	16V		TEMSVB21C106M-8R	K78120025		1-18	B	h2
C 1512	CHIP CAP.	0.01uF	25V	B	GRM39B103M25PT	K22144802		1-	B	h3
C 1513	CHIP CAP.	0.001uF	50V	B	GRM40B102M50PT	K22170805		1-	B	h2
C 1514	CHIP CAP.	0.01uF	50V	B	GRM40B103M50PT	K22170817		1-	B	h2
C 1515	CHIP CAP.	1uF	25V	W5R	CM32W5R105K25AT	K22145801		1-	A	B2
C 1515	CHIP CAP.	1uF	50V	B	GRM42-2B105K50PT	K22175801		19-	A	B2
C 1516	CHIP CAP.	1uF	10V	B	GRM40B105K10PT	K22100802		1-	B	h2
C 1517	CHIP CAP.	0.001uF	50V	B	GRM188B11H102KA01D	K22174821		1-	B	h2
C 1518	CHIP CAP.	0.001uF	50V	B	GRM40B102M50PT	K22170805		1-	B	g2
C 1519	CHIP CAP.	0.01uF	50V	B	GRM40B103M50PT	K22170817		1-	B	g2
C 1520	CHIP CAP.	1uF	25V	W5R	CM32W5R105K25AT	K22145801		1	A	B2
C 1521	CHIP CAP.	12pF	500V	CH	GRM42-6CH120J500PT	K22271215		1-6	A	C2
C 1521	CHIP CAP.	8pF	500V	CH	GRM42-6CH080D500PT	K22271211	VERSION A	7-	A	C2
C 1521	CHIP CAP.	8pF	500V	CH	GRM42-6CH080D500PT	K22271211	VERSION A	87-	A	C2
C 1521	CHIP CAP.	12pF	500V	CH	GRM42-6CH120J500PT	K22271215	VERSION C	7-91	A	C2
C 1522	CHIP CAP.	47pF	500V	CH	GRM42-6CH470J500PT	K22271229		1-6	A	D2
C 1522	CHIP CAP.	56pF	500V	CH	GRM42-6CH560J500PT	K22271231	VERSION A	7-	A	D2
C 1522	CHIP CAP.	47pF	500V	CH	GRM42-6CH470J500PT	K22271229	VERSION C	7-91	A	D2
C 1523	CHIP CAP.	5pF	500V	CH	GRM42-6CH050C500PT	K22271208		1-6	A	D2
C 1523	CHIP CAP.	5pF	500V	CH	GRM42-6CH050C500PT	K22271208	VERSION C	19-91	A	D2
C 1523	CHIP CAP.	3pF	500V	CJ	GRM42-6CJ030C500PT	K22271206	VERSION A	7-	A	D2
C 1523	CHIP CAP.	5pF	500V	CH	GRM42-6CH050C500PT	K22271208	VERSION C	7-18	A	D2
C 1524	FILM CAP.	390pF	500V		UC342H3900J-T	K33279040		1-6	A	D2
C 1524	FILM CAP.	180pF	500V		UC342H1800J-T	K33279039	VERSION A	38-91	A	D2
C 1524	FILM CAP.	180pF	500V		UC342H1800J-T	K33279039	VERSION A	92-	A	D2
C 1524	FILM CAP.	180pF	500V		UC342H1800J-T	K33279039	VERSION A	7-37	A	D2
C 1524	FILM CAP.	390pF	500V		UC342H3900J-T	K33279040	VERSION C	7-91	A	D2
C 1525	FILM CAP.	220pF	500V		UC342H2200J-T	K33279011		1-6	A	D2
C 1525	FILM CAP.	270pF	500V		UC342H2700J-T	K33279013	VERSION A	38-91	A	D2
C 1525	FILM CAP.	270pF	500V		UC342H2700J-T	K33279013	VERSION A	92-	A	D2
C 1525	FILM CAP.	270pF	500V		UC342H2700J-T	K33279013	VERSION A	7-37	A	D2
C 1525	FILM CAP.	220pF	500V		UC342H2200J-T	K33279011	VERSION C	7-91	A	D2
C 1526	CHIP TA.CAP.	10uF	16V		TEMSVB21C106M-8R	K78120025		1-	B	i2
C 1527	FILM CAP.	120pF	500V		UC342H1200J-T	K33279026		1-6	A	D2
C 1527	FILM CAP.	270pF	500V		UC342H2700J-T	K33279013	VERSION A	38-91	A	D2
C 1527	FILM CAP.	120pF	500V		UC342H1200J-T	K33279026	VERSION C	19-91	A	D2
C 1527	FILM CAP.	270pF	500V		UC342H2700J-T	K33279013	VERSION A	7-37	A	D2
C 1527	FILM CAP.	120pF	500V		UC342H1200J-T	K33279026	VERSION C	7-18	A	D2
C 1528	CHIP CAP.	0.01uF	25V	B	GRM39B103M25PT	K22144802		1-	B	i1
C 1529	FILM CAP.	82pF	500V		UC232H0820J-T	K33279033		1-6	A	E1
C 1529	FILM CAP.	100pF	500V		UC232H1000J-T	K33279048	VERSION A	7-	A	E1
C 1529	FILM CAP.	82pF	500V		UC232H0820J-T	K33279033	VERSION C	7-95	A	E1
C 1530	CHIP CAP.	120pF	300V	CG	C17CG121K3TXLT	K22253205		1-6	A	E2
C 1530	CHIP CAP.	120pF	300V	CG	C17CG121K3TXLT	K22253205	VERSION C	19-91	A	E2
C 1530	FILM CAP.	68pF	500V		UC232H0680J-T	K33279030	VERSION C	19-91	A	E2
C 1530	CHIP CAP.	150pF	300V	CG	C17CG151K3TXLT	K22253204	VERSION A	7-	A	E2

PA Unit

REF.	DESCRIPTION	VALUE	V/W	TOL.	MFR'S DESIG	VXSTD P/N	VERS.	LOT.	SIDE	LAYADR
C 1530	CHIP CAP.	150pF	300V	CG	ATC700B151KW300XT	K22253207	VERSION A	18-91	A	E2
C 1530	CHIP CAP.	120pF	300V	CG	C17CG121K3TXLT	K22253205	VERSION C	7-18	A	E2
C 1531	FILM CAP.	82pF	500V		UC232H0820J-T	K33279033		1-6	A	E1
C 1531	FILM CAP.	82pF	500V		UC232H0820J-T	K33279033	VERSION C	19-91	A	E1
C 1531	FILM CAP.	100pF	500V		UC232H1000J-T	K33279048	VERSION A	7-91	A	E1
C 1531	FILM CAP.	82pF	500V		UC232H0820J-T	K33279033	VERSION C	7-18	A	E1
C 1532	CHIP CAP.	0.01uF	25V	B	GRM39B103M25PT	K22144802		1-	B	i1
C 1533	AL.ELECTRO.CAP.	1000uF	25V		RJ3-25V102MI5#	K40149041		1-91	A	G1
C 1534	AL.ELECTRO.CAP.	1000uF	25V		RJ3-25V102MI5#	K40149041		1	A	D1
C 1534	AL.ELECTRO.CAP.	1000uF	25V		RJ3-25V102MI5#	K40149041		2-91	A	D1
C 1535	CHIP CAP.	0.001uF	500V	W5R	GRM42-6W5R102K500PT	K22271801		1-91	B	d1
C 1536	CHIP CAP.	0.01uF	200V	X7R	GRM42-6X7R103K200PT	K22231802		1-91	B	d1
C 1537	CHIP CAP.	1uF	25V	W5R	CM32W5R105K25AT	K22145801		1-	A	F1
C 1537	CHIP CAP.	1uF	50V	B	GRM42-2B105K50PT	K22175801		19-	A	F1
C 1538	CHIP CAP.	0.001uF	500V	W5R	GRM42-6W5R102K500PT	K22271801		1-91	B	d1
C 1539	CHIP CAP.	0.01uF	200V	X7R	GRM42-6X7R103K200PT	K22231802		1-91	B	c1
C 1540	FILM CAP.	82pF	500V		UC232H0820J-T	K33279033	VERSION A	7-	A	F2
C 1541	FILM CAP.	68pF	500V		UC232H0680J-T	K33279030		1-6	A	F2
C 1541	FILM CAP.	8pF	500V		UC232H0080D-T	K33279005	VERSION A	38-	A	F2
C 1541	FILM CAP.	68pF	500V		UC232H0680J-T	K33279030	VERSION C	19-91	A	F2
C 1541	FILM CAP.	8pF	500V		UC232H0080D-T	K33279005	VERSION A	23-37	A	F2
C 1541	FILM CAP.	68pF	500V		UC232H0680J-T	K33279030	VERSION C	7-18	A	F2
C 1542	FILM CAP.	12pF	500V		UC232H0120J-T	K33279020		1-6	A	F2
C 1542	FILM CAP.	9pF	500V		UC232H0090D-T	K33279047	VERSION A	38-	A	F2
C 1542	FILM CAP.	12pF	500V		UC232H0120J-T	K33279020	VERSION C	19-91	A	F2
C 1542	FILM CAP.	9pF	500V		UC232H0090D-T	K33279047	VERSION A	7-37	A	F2
C 1542	FILM CAP.	12pF	500V		UC232H0120J-T	K33279020	VERSION C	7-18	A	F2
C 1543	FILM CAP.	100pF	500V		UC342H1000J-T	K33279031		1-91	A	G2
C 1544	CHIP CAP.	0.001uF	50V	B	GRM188B11H102KA01D	K22174821		1-	B	g3
C 1546	FILM CAP.	15pF	500V		UC232H0150J-T	K33279028		1-6	A	G2
C 1546	FILM CAP.	18pF	500V		UC232H0180J-T	K33279029	VERSION A	38-	A	G2
C 1546	FILM CAP.	18pF	500V		UC232H0180J-T	K33279029	VERSION A	7-37	A	G2
C 1546	FILM CAP.	15pF	500V		UC232H0150J-T	K33279028	VERSION C	7-91	A	G2
C 1547	FILM CAP.	27pF	500V		UC232H0270J-T	K33279023		1-6	A	G2
C 1547	FILM CAP.	33pF	500V		UC232H0330J-T	K33279024	VERSION A	7-	A	G2
C 1547	FILM CAP.	27pF	500V		UC232H0270J-T	K33279023	VERSION C	7-91	A	G2
C 1548	CHIP CAP.	1pF	50V	CK	GRM2164C1H1R0CD01D	K22170202		1-18	B	c2
C 1549	CHIP CAP.	0.001uF	50V	B	GRM188B11H102KA01D	K22174821		1-	B	g3
C 1550	CHIP CAP.	0.001uF	50V	B	GRM188B11H102KA01D	K22174821		1-	B	g2
C 1552	CHIP CAP.	1pF	50V	CK	GRM2164C1H1R0CD01D	K22170202		1-	B	b2
C 1553	CHIP CAP.	0.001uF	50V	B	GRM188B11H102KA01D	K22174821		1-	B	c2
C 1554	FILM CAP.	27pF	500V		UC232H0270J-T	K33279023		1-6	A	H2
C 1554	FILM CAP.	47pF	500V		UC232H0470J-T	K33279034	VERSION A	7-	A	H2
C 1554	FILM CAP.	27pF	500V		UC232H0270J-T	K33279023	VERSION C	7-91	A	H2
C 1556	FILM CAP.	27pF	500V		UC232H0270J-T	K33279023		1-6	A	H1
C 1556	FILM CAP.	33pF	500V		UC232H0330J-T	K33279024	VERSION A	7-	A	H1
C 1556	FILM CAP.	27pF	500V		UC232H0270J-T	K33279023	VERSION C	7-91	A	H1
C 1557	CHIP CAP.	0.001uF	50V	B	GRM188B11H102KA01D	K22174821		1-	B	b2
C 1558	CHIP CAP.	1pF	50V	CK	GRM2164C1H1R0CD01D	K22170202		1-	B	b2
C 1559	CHIP CAP.	0.001uF	50V	B	GRM188B11H102KA01D	K22174821		1-	B	g3
C 1560	FILM CAP.	15pF	500V		UC232H0150J-T	K33279028		1-6	A	I2
C 1560	FILM CAP.	18pF	500V		UC232H0180J-T	K33279029	VERSION A	7-	A	I2
C 1560	FILM CAP.	15pF	500V		UC232H0150J-T	K33279028	VERSION C	7-91	A	I2
C 1561	FILM CAP.	470pF	500V		UC342H4700J-T	K33279015		1-91	B	a2
C 1562	CHIP CAP.	0.001uF	50V	B	GRM188B11H102KA01D	K22174821		1-	B	f3
C 1563	CHIP CAP.	0.001uF	50V	B	GRM188B11H102KA01D	K22174821		1-	B	g3
C 1564	AL.ELECTRO.CAP.	1000uF	25V		RJ3-25V102MI5#	K40149041		1-91	A	G1
C 1565	CHIP CAP.	0.01uF	50V	B	GRM40B103M50PT	K22170817		1-	B	i2
C 1566	FILM CAP.	27pF	500V		UC232H0270J-T	K33279023		1-6	A	H2
C 1566	FILM CAP.	33pF	500V		UC232H0330J-T	K33279024	VERSION A	7-	A	H2

REF.	DESCRIPTION	VALUE	V/W	TOL.	MFR'S DESIG	VXSTD P/N	VERS.	LOT.	SIDE	LAYADR
C 1566	FILM CAP.	27pF	500V		UC232H0270J-T	K33279023	VERSION C	7-91	A	H2
C 1567	FILM CAP.	56pF	500V		UC232H0560J-T	K33279035		1-6		
C 1567	FILM CAP.	68pF	500V		UC232H0680J-T	K33279030	VERSION A	7-91		
C 1567	FILM CAP.	56pF	500V		UC232H0560J-T	K33279035	VERSION C	7-18		
C 1567	FILM CAP.	56pF	500V		UC232H0560J-T	K33279035	VERSION C	19-91		
C 1568	FILM CAP.	470pF	500V		UC342H4700J-T	K33279015		1-6		
C 1568	FILM CAP.	470pF	500V		UC342H4700J-T	K33279015	VERSION C	7-18		
C 1568	FILM CAP.	470pF	500V		UC342H4700J-T	K33279015	VERSION C	19-91		
D 1501	DIODE				RN739F T106	G2070626		1-	B	i2
D 1502	DIODE				MA143-(TX)	G2070536		1-	B	i2
D 1503	DIODE				1SS319 TE85R	G2070080		1-91	B	b2
D 1504	DIODE				1SS319 TE85R	G2070080		1-91	B	b2
FB1501	M.RFC				FBA03VA450AB-00	L1190389		1-91	A	B2
FB1502	FERRITE BEADS				4A2 RI3X3-1	L9190001		1-91		
FB1503	FERRITE BEADS				4A2 RI3X3-1	L9190001		1-91		
J 1501	CONNECTOR				TMP-J01X-V6	P1090210		1-	A	A2
JP1501	WIRE ASSY				A1367+	T9206790		1-	A	C3
JP1502	WIRE ASSY				A1367+	T9206787A		1-18		
JP1502	WIRE ASSY				A1367+	T9206787A		19-		
JP1503	WIRE ASSY				RED 230 FV2/(3)	T9318118		1-18	A	F1
JP1503	WIRE ASSY				RED 230 FV2/(3)	T9318118		19-	A	F1
JP1504	WIRE ASSY				BLK 240 FV2/(3)	T9318119		1-18	A	F1
JP1504	WIRE ASSY				BLK 240 FV2/(3)	T9318119		19-	A	F1
L 1501	M.RFC	0.022uH			HK2125 22NK-T	L1690381		1-	B	i2
L 1502	M.RFC	0.056uH			HK2125 56NK-T	L1690386		1-	B	h2
L 1503	COIL A1				4.5T4.5D0.8UEW R	L0021907A		1	A	B2
L 1504	COIL A1				5.5T2.5D0.5UEW R	L0021808A		1-22	A	C2
L 1504	COIL A1				4.5T2.5D0.5UEW R	L0021807A	VERSION A	23-	A	C2
L 1504	COIL A1				5.5T2.5D0.5UEW R	L0021808A	VERSION C	23-91	A	C2
L 1505	COIL A1				2.5T3.0D0.6UEW R	L0021811A		1-91	A	C2
L 1506	COIL A1				8.5T3.0D0.5UEW R	L0020724A		1-91	A	D2
L 1507	COIL A1				3.5T5.0D1.2UEW R	L0022130		1-91	A	F1
L 1508	COIL A1				3.5T5.0D1.2UEW R	L0022130		1-91	A	F1
L 1509	COIL A1				1.5T3.0D1.2UEW R	L0022152		1-91	A	F2
L 1510	COIL A1				1.5T5.0D1.2UEW R	L0022163		1-91	A	F2
L 1511	COIL A1				3.5T6.0D1.2UEW R	L0022614		1-91	A	G2
L 1512	COIL A1				3.5T6.0D1.2UEW R	L0022614		1-91	A	G2
L 1513	COIL A1				3.5T6.0D1.2UEW R	L0022614		1-91	A	H2
L 1514	COIL A1				3.5T6.0D1.2UEW R	L0022614		1-91	A	I2
L 1515	COIL A1				3.5T6.0D1.2UEW R	L0022614		1-91	A	H1
Q 1501	TRANSISTOR				2SC3357-T2 RF	G3333577F		1-	B	i2
Q 1502	IC				PF0313-04	G1092949	VERSION A	7-	A	A1
Q 1502	IC				RA08N1317M	G1094268	VERSION A	87-91	A	A1
Q 1502	IC				PF0314-04	G1092850	VERSION C	1-91	A	A1
Q 1503	TRANSISTOR				2SB1122S-TD	G3211228S		1-91	B	h2
Q 1504	TRANSISTOR				2SC4116GR TE85R	G3341167G		1-	B	h2
Q 1505	TRANSISTOR				2SB1122S-TD	G3211228S		1-91	B	h3
Q 1506	TRANSISTOR				UN5213-(TX)	G3070192		1-	B	h3
Q 1507	TRANSISTOR				2SC5125-21	G3351250		1-91	A	E2
Q 1508	IC				NJM78L09UA-TE2	G1091305		1-	B	i1
Q 1509	IC				TA75S01F TE85R	G1091593		1-91	B	g3
R 1501	CHIP RES.	270	1/16W	5%	RMC1/16 271JATP	J24185271		1-	B	i2
R 1502	CHIP RES.	270	1/16W	5%	RMC1/16 271JATP	J24185271		1-	B	i2
R 1503	CHIP RES.	5.6k	1/16W	5%	RMC1/16 562JATP	J24185562		1-	B	i3
R 1504	CHIP RES.	100	1/16W	5%	RMC1/16 101JATP	J24185101		1-	B	i2
R 1505	CHIP RES.	4.7	1/10W	5%	RMC1/10T 4R7J	J24205479		1-	B	i2
R 1506	CHIP RES.	1.5k	1/16W	5%	RMC1/16 152JATP	J24185152		1-	B	i2
R 1507	CHIP RES.	1.5k	1/16W	5%	RMC1/16 152JATP	J24185152		1-	B	i2
R 1508	CHIP RES.	470	1/10W	5%	RMC1/10T 471J	J24205471		1-86	A	B2
R 1508	CHIP RES.	270	1/10W	5%	RMC1/10T 271J	J24205271	VERSION A	87-	A	B2

PA Unit

REF.	DESCRIPTION	VALUE	V/W	TOL.	MFR'S DESIG	VXSTD P/N	VERS.	LOT.	SIDE	LAYADR
R 1508	CHIP RES.	470	1/10W	5%	RMC1/10T 471J	J24205471	VERSION C	87-	A	B2
R 1509	CHIP RES.	10	1/10W	5%	RMC1/10T 100J	J24205100		1-86	A	B2
R 1509	CHIP RES.	22	1/10W	5%	RMC1/10T 220J	J24205220	VERSION A	87-	A	B2
R 1509	CHIP RES.	10	1/10W	5%	RMC1/10T 100J	J24205100	VERSION C	87-	A	B2
R 1510	CHIP RES.	470	1/10W	5%	RMC1/10T 471J	J24205471		1-86	A	B2
R 1510	CHIP RES.	270	1/10W	5%	RMC1/10T 271J	J24205271	VERSION A	87-	A	B2
R 1510	CHIP RES.	470	1/10W	5%	RMC1/10T 471J	J24205471	VERSION C	87-	A	B2
R 1510	CHIP RES.	270	1/10W	5%	RMC1/10T 271J	J24205271	VERSION C	92-	A	B2
R 1511	CHIP RES.	470	1/16W	5%	RMC1/16 471JATP	J24185471		1-	A	B2
R 1511	CHIP RES.	680	1/16W	5%	RMC1/16 681JATP	J24185681		87-	A	B2
R 1512	CHIP RES.	1k	1/16W	5%	RMC1/16 102JATP	J24185102		1-	A	B2
R 1513	CHIP RES.	2.2k	1/16W	5%	RMC1/16 222JATP	J24185222		1-	B	h2
R 1514	CHIP RES.	22	1/16W	5%	RMC1/16 220JATP	J24185220		1-	B	h2
R 1515	CHIP RES.	1k	1/16W	5%	RMC1/16 102JATP	J24185102		1-	B	h2
R 1516	CHIP RES.	2.2k	1/16W	5%	RMC1/16 222JATP	J24185222		1-	B	h3
R 1517	CHIP RES.	10k	1/16W	5%	RMC1/16 103JATP	J24185103		1-	B	h3
R 1519	CHIP RES.	1k	1/16W	5%	RMC1/16 102JATP	J24185102		1-	B	h3
R 1520	CHIP RES.	33k	1/16W	5%	RMC1/16 333JATP	J24185333		1-	B	h3
R 1521	CHIP RES.	10k	1/16W	5%	RMC1/16 103JATP	J24185103		1-	B	g2
R 1522	CHIP RES.	100k	1/16W	5%	RMC1/16 104JATP	J24185104		1-	B	g3
R 1523	CHIP RES.	10k	1/10W	5%	RMC1/10T 103J	J24205103		1-18	B	c2
R 1523	CHIP RES.	10k	1/10W	5%	RMC1/10T 103J	J24205103	VERSION C	19-	B	c2
R 1523	CHIP RES.	10k	1/10W	5%	RMC1/10T 103J	J24205103	VERSION A	19-	B	c2
R 1523	CHIP RES.	6.8k	1/10W	5%	RMC1/10T 682J	J24205682	VERSION A	23-	B	c2
R 1524	CHIP RES.	4.7k	1/16W	5%	RMC1/16 472JATP	J24185472		1-18	B	c2
R 1524	CHIP RES.	4.7k	1/16W	5%	RMC1/16 472JATP	J24185472	VERSION A	38-	B	c2
R 1524	CHIP RES.	4.7k	1/16W	5%	RMC1/16 472JATP	J24185472	VERSION C	19-	B	c2
R 1524	CHIP RES.	4.7k	1/16W	5%	RMC1/16 472JATP	J24185472	VERSION A	19-37	B	c2
R 1525	CHIP RES.	1k	1/16W	5%	RMC1/16 102JATP	J24185102		1-	B	g3
R 1526	CHIP RES.	10k	1/16W	5%	RMC1/16 103JATP	J24185103		1-	B	g2
R 1527	CHIP RES.	10k	1/10W	5%	RMC1/10T 103J	J24205103		1-18	B	b2
R 1527	CHIP RES.	10k	1/10W	5%	RMC1/10T 103J	J24205103	VERSION C	19-	B	b2
R 1527	CHIP RES.	10k	1/10W	5%	RMC1/10T 103J	J24205103	VERSION A	19-	B	b2
R 1527	CHIP RES.	6.8k	1/10W	5%	RMC1/10T 682J	J24205682	VERSION A	23-	B	b2
R 1528	CHIP RES.	4.7k	1/16W	5%	RMC1/16 472JATP	J24185472		1-18	B	b2
R 1528	CHIP RES.	4.7k	1/16W	5%	RMC1/16 472JATP	J24185472	VERSION A	38-	B	b2
R 1528	CHIP RES.	4.7k	1/16W	5%	RMC1/16 472JATP	J24185472	VERSION C	19-	B	b2
R 1528	CHIP RES.	4.7k	1/16W	5%	RMC1/16 472JATP	J24185472	VERSION A	19-37	B	b2
R 1529	CHIP RES.	47k	1/10W	5%	RMC1/10T 473J	J24205473		1-	B	a3
R 1530	CHIP RES.	47k	1/10W	5%	RMC1/10T 473J	J24205473		1-	B	a3
R 1533	CHIP RES.	1k	1/16W	5%	RMC1/16 102JATP	J24185102		1-		
TH1501	THERMISTOR				NT732ATD2.0K K	G9090079		1-	A	D3
	LEAF SPRING					R0140031		1-18		
	NYLON CLAMP				PLT-1M BK-1	S3000022		1-		
	GROUND PLATE					RA0015200		1-91		
	GAP PAD				GP1-5.2-015025	S6000379		1-91		

Circuit Diagram

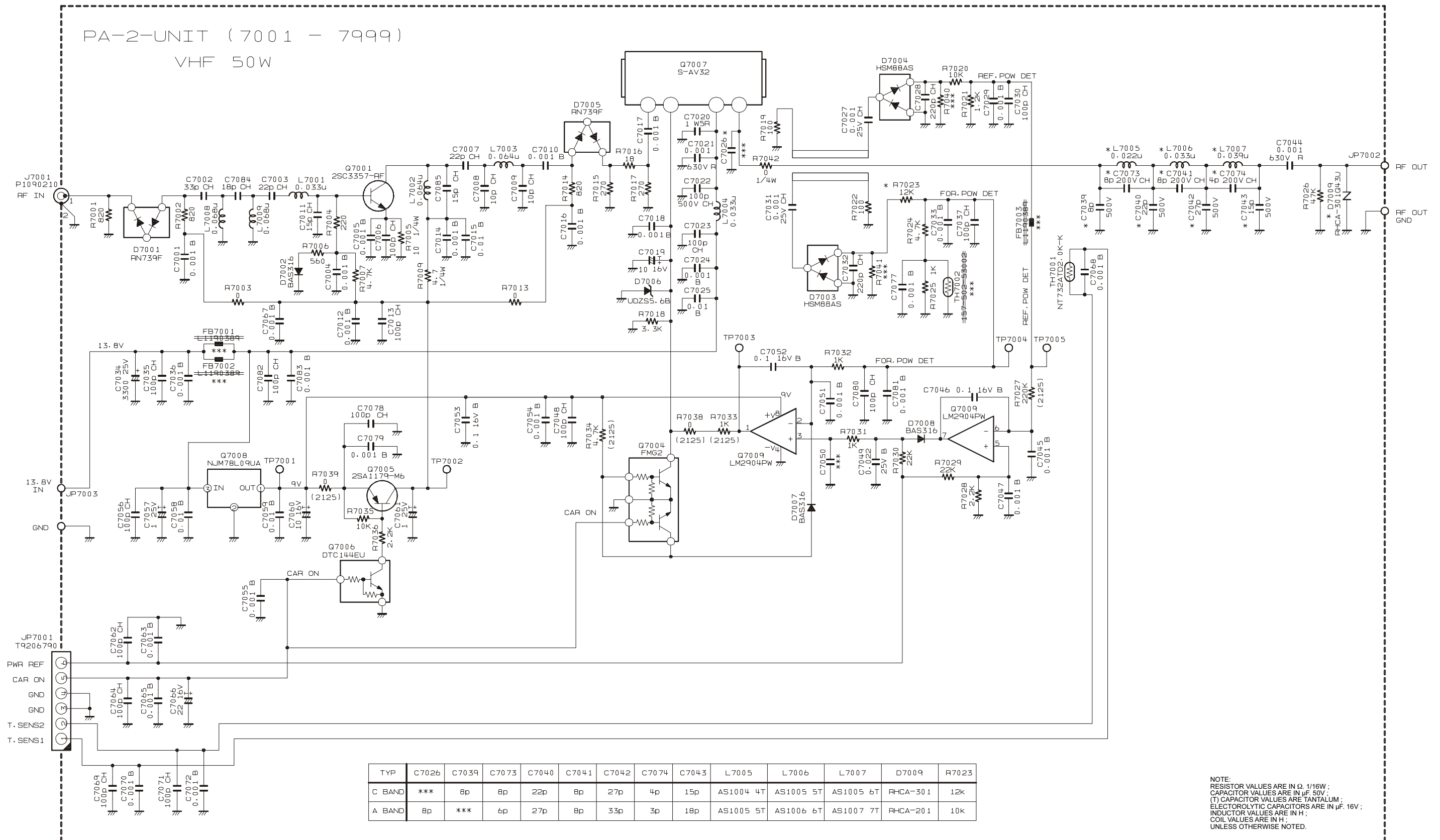

PA-2 Unit (Lot. 92~)

Note

Parts Layout

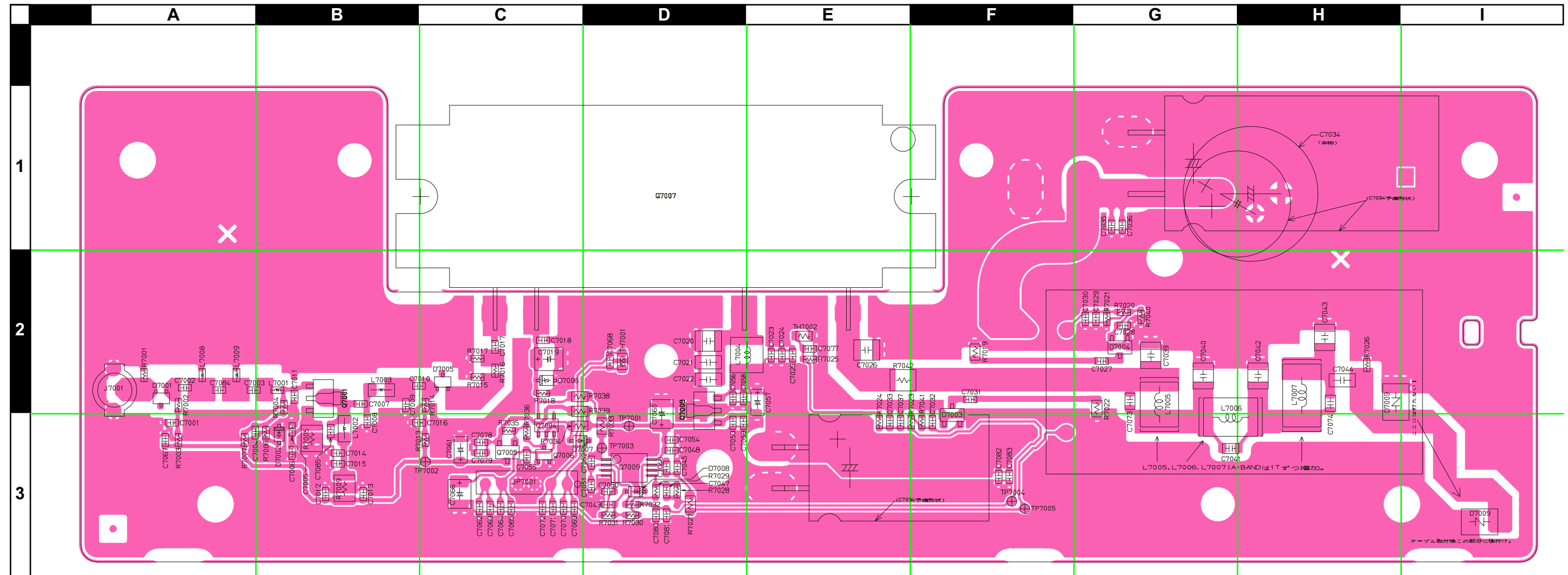

Side A

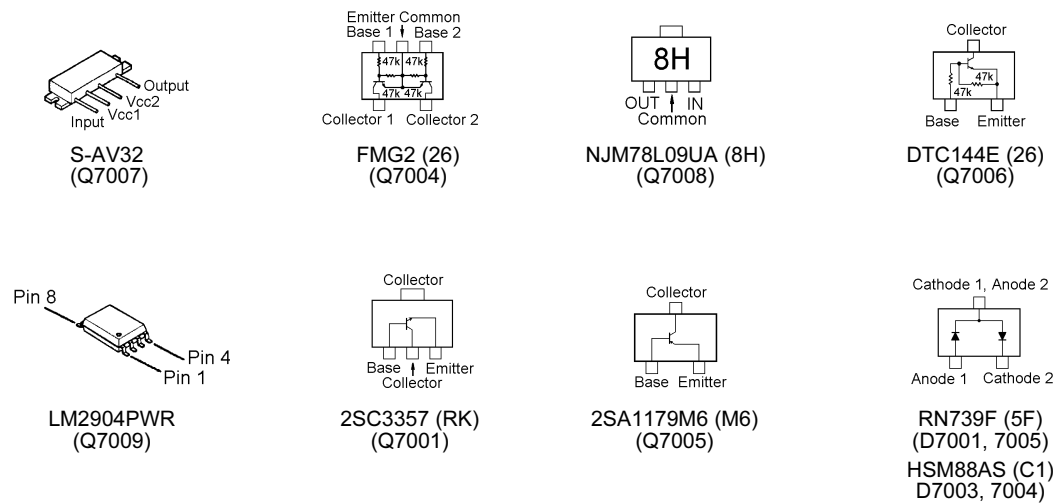

PA-2 Unit (Lot. 92~)

Parts Layout

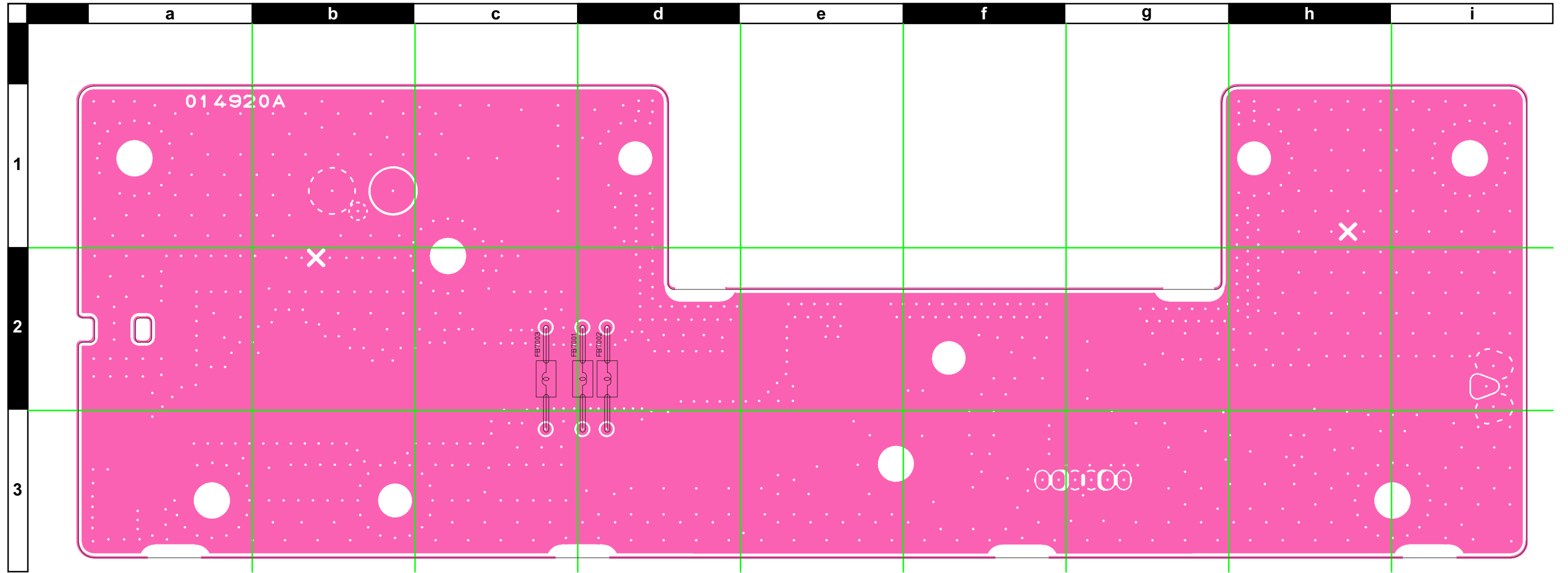

Side B

PA-2 Unit (Lot. 92~)

Parts List

REF.	DESCRIPTION	VALUE	V/W	TOL.	MFR'S DESIG	VXSTD P/N	VERS.	LOT.	SIDE	LAYADR
*** PA-2 UNIT ***										
PCB with Components						CS1870001	VERSION C			
PCB with Components						CS1870002	VERSION A			
	Printed Circuit Board					FR014920A		92-		
C 7001	CHIP CAP.	0.001uF	50V	B	GRM188B11H102KA01D	K22174821		92-	A	A3
C 7002	CHIP CAP.	33pF	50V	CH	GRM1882C1H330JA01D	K22174223		92-	A	A2
C 7003	CHIP CAP.	22pF	50V	CH	GRM1882C1H220JA01D	K22174219		92-	A	B2
C 7004	CHIP CAP.	0.001uF	50V	B	GRM188B11H102KA01D	K22174821		92-	A	B3
C 7005	CHIP CAP.	0.001uF	50V	B	GRM188B11H102KA01D	K22174821		92-	A	B3
C 7006	CHIP CAP.	100pF	50V	CH	GRM1882C1H101JA01D	K22174235		92-	A	B3
C 7007	CHIP CAP.	22pF	50V	CH	GRM1882C1H220JA01D	K22174219		92-	A	B2
C 7008	CHIP CAP.	10pF	50V	CH	GRM1882C1H100JA01D	K22174211		92-	A	B3
C 7009	CHIP CAP.	10pF	50V	CH	GRM1882C1H100JA01D	K22174211		92-	A	B2
C 7010	CHIP CAP.	0.001uF	50V	B	GRM188B11H102KA01D	K22174821		92-	A	C2
C 7011	CHIP CAP.	15pF	50V	CH	GRM1882C1H150JA01D	K22174215		92-	A	B2
C 7012	CHIP CAP.	0.001uF	50V	B	GRM188B11H102KA01D	K22174821		92-	A	B3
C 7013	CHIP CAP.	100pF	50V	CH	GRM1882C1H101JA01D	K22174235		92-	A	B3
C 7014	CHIP CAP.	0.001uF	50V	B	GRM188B11H102KA01D	K22174821		92-	A	B3
C 7015	CHIP CAP.	0.01uF	50V	B	GRM188B11H103KA01D	K22174823		92-	A	B3
C 7016	CHIP CAP.	0.001uF	50V	B	GRM188B11H102KA01D	K22174821		92-	A	C3
C 7017	CHIP CAP.	0.001uF	50V	B	GRM188B11H102KA01D	K22174821		92-	A	C2
C 7018	CHIP CAP.	0.001uF	50V	B	GRM188B11H102KA01D	K22174821		92-	A	C2
C 7019	CHIP TA.CAP.	10uF	16V		TEMSVB21C106M-8R	K78120025		92-	A	C2
C 7020	CHIP CAP.	1uF	50V	B	GRM42-2B105K50PT	K22175801		92-	A	D2
C 7021	CHIP CAP.	0.001uF	630V	R	GRM31BR32J102KY01L	K22281801		92-	A	D2
C 7022	CHIP CAP.	100pF	500V	CH	CF316CH101J500AT	K22271267		92-	A	D2
C 7023	CHIP CAP.	100pF	50V	CH	GRM1882C1H101JA01D	K22174235		92-	A	E2
C 7024	CHIP CAP.	0.001uF	50V	B	GRM188B11H102KA01D	K22174821		92-	A	E2
C 7025	CHIP CAP.	0.01uF	50V	B	GRM188B11H103KA01D	K22174823		92-	A	E2
C 7026	FILM CAP.	8pF	500V		UC232H0080D-T	K33279005	VERSION A	92-	A	E2
C 7027	CHIP CAP.	0.001uF	25V	CH	GRM1882C1E102JA01D	K22144204		92-	A	G2
C 7028	CHIP CAP.	220pF	50V	CH	GRM1882C1H221JA01D	K22174243		92-	A	G2
C 7029	CHIP CAP.	0.001uF	50V	B	GRM188B11H102KA01D	K22174821		92-	A	G2
C 7030	CHIP CAP.	100pF	50V	CH	GRM1882C1H101JA01D	K22174235		92-	A	G2
C 7031	CHIP CAP.	0.001uF	25V	CH	GRM1882C1E102JA01D	K22144204		92-	A	F2
C 7032	CHIP CAP.	220pF	50V	CH	GRM1882C1H221JA01D	K22174243		92-	A	F3
C 7033	CHIP CAP.	0.001uF	50V	B	GRM188B11H102KA01D	K22174821		92-	A	E3
C 7034	AL.ELECTRO.CAP.	3300uF	25V		RJ3-25V332MJ7#	K40149070		92-	A	G1
C 7035	CHIP CAP.	100pF	50V	CH	GRM1882C1H101JA01D	K22174235		92-	A	G1
C 7036	CHIP CAP.	0.001uF	50V	B	GRM188B11H102KA01D	K22174821		92-	A	G1
C 7037	CHIP CAP.	100pF	50V	CH	GRM1882C1H101JA01D	K22174235		92-	A	F3
C 7039	FILM CAP.	8pF	500V		UC232H0080D-T	K33279005	VERSION C	92-	A	G2
C 7040	FILM CAP.	27pF	500V		UC232H0270J-T	K33279023	VERSION A	92-	A	G2
C 7040	FILM CAP.	22pF	500V		UC232H0220J-T	K33279021	VERSION C	92-	A	G2
C 7041	CHIP CAP.	8pF	200V	CH	GRM2192C2D8R0DY21D	K22230214	VERSION A	92-	A	H3
C 7041	CHIP CAP.	8pF	200V	CH	GRM2192C2D8R0DY21D	K22230214	VERSION C	92-	A	H3
C 7042	FILM CAP.	33pF	500V		UC232H0330J-T	K33279024	VERSION A	92-	A	H2
C 7042	FILM CAP.	27pF	500V		UC232H0270J-T	K33279023	VERSION C	92-	A	H2
C 7043	FILM CAP.	18pF	500V		UC232H0180J-T	K33279029	VERSION A	92-	A	H2
C 7043	FILM CAP.	15pF	500V		UC232H0150J-T	K33279028	VERSION C	92-	A	H2
C 7044	CHIP CAP.	0.001uF	630V	R	GRM31BR32J102KY01L	K22281801		92-	A	H2
C 7045	CHIP CAP.	0.001uF	50V	B	GRM188B11H102KA01D	K22174821		92-	A	D3
C 7046	CHIP CAP.	0.1uF	16V	B	GRM188B11C104KA01D	K22124805		92-	A	D3
C 7047	CHIP CAP.	0.001uF	50V	B	GRM188B11H102KA01D	K22174821		92-	A	D3
C 7048	CHIP CAP.	100pF	50V	CH	GRM1882C1H101JA01D	K22174235		92-	A	D3
C 7049	CHIP CAP.	0.022uF	25V	B	GRM39B223K25PT	K22144807		92-	A	D3
C 7051	CHIP CAP.	0.001uF	50V	B	GRM188B11H102KA01D	K22174821		92-	A	D3
C 7052	CHIP CAP.	0.1uF	16V	B	GRM188B11C104KA01D	K22124805		92-	A	D3
C 7053	CHIP CAP.	0.1uF	16V	B	GRM188B11C104KA01D	K22124805		92-	A	D3
C 7054	CHIP CAP.	0.001uF	50V	B	GRM188B11H102KA01D	K22174821		92-	A	D3
C 7055	CHIP CAP.	0.001uF	50V	B	GRM188B11H102KA01D	K22174821		92-	A	C3
C 7056	CHIP CAP.	100pF	50V	CH	GRM1882C1H101JA01D	K22174235		92-	A	D2
C 7057	CHIP TA.CAP.	1uF	25V		TEMSVA1E105M-8R	K78140013		92-	A	E2
C 7058	CHIP CAP.	0.01uF	50V	B	GRM188B11H103KA01D	K22174823		92-	A	E2
C 7059	CHIP CAP.	0.01uF	50V	B	GRM188B11H103KA01D	K22174823		92-	A	E3
C 7060	CHIP TA.CAP.	10uF	16V		TEMSVB21C106M-8R	K78120025		92-	A	D2
C 7061	CHIP TA.CAP.	1uF	25V		TEMSVA1E105M-8R	K78140013		92-	A	C3

PA-2 Unit (Lot. 92~)

Parts List

REF.	DESCRIPTION	VALUE	V/W	TOL.	MFR'S DESIG	VXSTD P/N	VERS.	LOT.	SIDE	LAYADR
C 7062	CHIP CAP.	100pF	50V	CH	GRM1882C1H101JA01D	K22174235		92-	A	C3
C 7063	CHIP CAP.	0.001uF	50V	B	GRM188B11H102KA01D	K22174821		92-	A	C3
C 7064	CHIP CAP.	100pF	50V	CH	GRM1882C1H101JA01D	K22174235		92-	A	C3
C 7065	CHIP CAP.	0.001uF	50V	B	GRM188B11H102KA01D	K22174821		92-	A	C3
C 7066	CHIP TA.CAP.	22uF	16V		TEMSVB21C226M-8R	K78120028		92-	A	C3
C 7067	CHIP CAP.	0.001uF	50V	B	GRM188B11H102KA01D	K22174821		92-	A	A3
C 7068	CHIP CAP.	0.001uF	50V	B	GRM188B11H102KA01D	K22174821		92-	A	D2
C 7069	CHIP CAP.	100pF	50V	CH	GRM1882C1H101JA01D	K22174235		92-	A	D3
C 7070	CHIP CAP.	0.001uF	50V	B	GRM188B11H102KA01D	K22174821		92-	A	C3
C 7071	CHIP CAP.	100pF	50V	CH	GRM1882C1H101JA01D	K22174235		92-	A	C3
C 7072	CHIP CAP.	0.001uF	50V	B	GRM188B11H102KA01D	K22174821		92-	A	C3
C 7073	CHIP CAP.	6pF	200V	CH	GRM2192C2D6R0DY21D	K22230212	VERSION A	92-	A	G2
C 7073	CHIP CAP.	8pF	200V	CH	GRM2192C2D8R0DY21D	K22230214	VERSION C	92-	A	G2
C 7074	CHIP CAP.	3pF	200V	CJ	GRM2193C2D3R0CY21D	K22230210	VERSION A	92-	A	H2
C 7074	CHIP CAP.	4pF	200V	CH	GRM2192C2D4R0CY21D	K22230211	VERSION C	92-	A	H2
C 7077	CHIP CAP.	0.001uF	50V	B	GRM188B11H102KA01D	K22174821		92-	A	E2
C 7078	CHIP CAP.	100pF	50V	CH	GRM1882C1H101JA01D	K22174235		92-	A	C3
C 7079	CHIP CAP.	0.001uF	50V	B	GRM188B11H102KA01D	K22174821		92-	A	C3
C 7080	CHIP CAP.	100pF	50V	CH	GRM1882C1H101JA01D	K22174235		92-	A	D3
C 7081	CHIP CAP.	0.001uF	50V	B	GRM188B11H102KA01D	K22174821		92-	A	D3
C 7082	CHIP CAP.	100pF	50V	CH	GRM1882C1H101JA01D	K22174235		92-	A	F3
C 7083	CHIP CAP.	0.001uF	50V	B	GRM188B11H102KA01D	K22174821		92-	A	F3
C 7084	CHIP CAP.	18pF	50V	CH	GRM1882C1H180JA01D	K22174217		92-	A	A2
C 7085	CHIP CAP.	15pF	50V	CH	GRM1882C1H150JA01D	K22174215		92-	A	B3
D 7001	DIODE				RN739F T106	G2070626		92-	A	A2
D 7002	DIODE				BAS316	G2070716		92-	A	B3
D 7003	DIODE				HSM88AS TR	G2070170		92-	A	F3
D 7004	DIODE				HSM88AS TR	G2070170		92-	A	G2
D 7005	DIODE				RN739F T106	G2070626		92-	A	C2
D 7006	DIODE				UDZS TE-17 5.6B	G2070910		92-	A	C2
D 7007	DIODE				BAS316	G2070716		92-	A	D3
D 7008	DIODE				BAS316	G2070716		92-	A	D3
D 7009	SURGE ABSORBER				RHCA-201Q43U	Q9000825	VERSION A	92-	A	I2
D 7009	SURGE ABSORBER				RHCA-301Q43U	Q9000827	VERSION C	92-	A	I2
J 7001	CONNECTOR				TMP-J01X-V6	P1090210		92-	A	A2
JP7001	WIRE ASSY				A1367+	T9206790		92-	A	C3
JP7002	WIRE ASSY				A1367+	T9206787A		92-		
JP7003	WIRE ASSY				RED 230 FV2/(3)	T9318118		92-		
JP7004	WIRE ASSY				BLK 240 FV2/(3)	T9318119		92-		
L 7001	M.RFC	0.033uH			HK1608 33NJ-T	L1690522		92-	A	B2
L 7002	CHIP COIL	0.064uH			LQW31HN64NJ03L	L1690258		92-	A	B3
L 7003	CHIP COIL	0.064uH			LQW31HN64NJ03L	L1690258		92-	A	B2
L 7004	COIL	0.033uH			AS0804-33NK	L0022538		92-	A	E2
L 7005	COIL	0.033uH			AS1005-33NK	L0022546	VERSION A	92-	A	G2
L 7005	COIL	0.022uH			AS1004-22NK	L0022545	VERSION C	92-	A	G2
L 7006	COIL	0.039uH			AS1006-39NK	L0022547	VERSION A	92-	A	H3
L 7006	COIL	0.033uH			AS1005-33NK	L0022546	VERSION C	92-	A	H3
L 7007	COIL	0.047uH			AS1007-47NK	L0022548	VERSION A	92-	A	H2
L 7007	COIL	0.039uH			AS1006-39NK	L0022547	VERSION C	92-	A	H2
L 7008	M.RFC	0.068uH			ELJ-RE68NJF3	L1690724		92-	A	A2
L 7009	M.RFC	0.068uH			ELJ-RE68NJF3	L1690724		92-	A	A2
Q 7001	TRANSISTOR				2SC3357-T2 RF	G3333577F		92-	A	B2
Q 7004	TRANSISTOR				FMG2 T148	G3070015		92-	A	C3
Q 7005	TRANSISTOR				2SA1179M6-TA	G3111797F		92-	A	C3
Q 7006	TRANSISTOR				DTC144EUA T106	G3070041		92-	A	C3
Q 7007	IC				S-AV32(VX)	G1093916		92-	A	C1
Q 7008	IC				NJM78L09UA-TE2	G1091305		92-	A	D2
Q 7009	IC				LM2904PWR	G1094010		92-	A	D3
R 7001	CHIP RES.	820	1/16W	5%	RMC1/16 821JATP	J24185821		92-	A	A2
R 7002	CHIP RES.	820	1/16W	5%	RMC1/16 821JATP	J24185821		92-	A	A2
R 7003	CHIP RES.	0	1/16W	5%	RMC1/16 000JATP	J24185000		92-	A	A3
R 7004	CHIP RES.	220	1/16W	5%	RMC1/16 221JATP	J24185221		92-	A	B2
R 7005	CHIP RES.	10	1/4W	5%	RMC1/4 100JATP	J24245100		92-	A	B3
R 7006	CHIP RES.	560	1/16W	5%	RMC1/16 561JATP	J24185561		92-	A	B3
R 7007	CHIP RES.	4.7k	1/16W	5%	RMC1/16 472JATP	J24185472		92-	A	B3
R 7009	CHIP RES.	4.7	1/4W	5%	RMC1/4 4R7JATP	J24245479		92-	A	B3
R 7013	CHIP RES.	0	1/16W	5%	RMC1/16 000JATP	J24185000		92-	A	C3

PA-2 Unit (Lot. 92~)

Parts List

REF.	DESCRIPTION	VALUE	V/W	TOL.	MFR'S DESIG	VXSTD P/N	VERS.	LOT.	SIDE	LAYADR
R 7014	CHIP RES.	820	1/16W	5%	RMC1/16 821JATP	J24185821		92-	A	C2
R 7015	CHIP RES.	270	1/16W	5%	RMC1/16 271JATP	J24185271		92-	A	C2
R 7016	CHIP RES.	18	1/16W	5%	RMC1/16 180JATP	J24185180		92-	A	C2
R 7017	CHIP RES.	270	1/16W	5%	RMC1/16 271JATP	J24185271		92-	A	C2
R 7018	CHIP RES.	3.3k	1/16W	5%	RMC1/16 332JATP	J24185332		92-	A	C2
R 7019	CHIP RES.	100	1/10W	5%	RMC1/10T 101J	J24205101		92-	A	F2
R 7020	CHIP RES.	10k	1/16W	5%	RMC1/16 103JATP	J24185103		92-	A	G2
R 7021	CHIP RES.	1.2k	1/16W	5%	RMC1/16 122JATP	J24185122		92-	A	G2
R 7022	CHIP RES.	100	1/10W	5%	RMC1/10T 101J	J24205101		92-	A	G2
R 7023	CHIP RES.	10k	1/16W	5%	RMC1/16 103JATP	J24185103	VERSION A	92-	A	F3
R 7023	CHIP RES.	12k	1/16W	5%	RMC1/16 123JATP	J24185123	VERSION C	92-	A	F3
R 7024	CHIP RES.	4.7k	1/16W	5%	RMC1/16 472JATP	J24185472		92-	A	E3
R 7025	CHIP RES.	1k	1/16W	5%	RMC1/16 102JATP	J24185102		92-	A	E2
R 7026	CHIP RES.	47k	1/16W	5%	RMC1/16 473JATP	J24185473		92-	A	H2
R 7027	CHIP RES.	220k	1/10W	5%	RMC1/10T 224J	J24205224		92-	A	D3
R 7028	CHIP RES.	2.2k	1/16W	5%	RMC1/16 222JATP	J24185222		92-	A	D3
R 7029	CHIP RES.	22k	1/16W	5%	RMC1/16 223JATP	J24185223		92-	A	D3
R 7030	CHIP RES.	22k	1/16W	5%	RMC1/16 223JATP	J24185223		92-	A	D3
R 7031	CHIP RES.	1k	1/16W	5%	RMC1/16 102JATP	J24185102		92-	A	D3
R 7032	CHIP RES.	1k	1/16W	5%	RMC1/16 102JATP	J24185102		92-	A	D3
R 7033	CHIP RES.	1k	1/10W	5%	RMC1/10T 102J	J24205102		92-	A	D3
R 7034	CHIP RES.	4.7k	1/10W	5%	RMC1/10T 472J	J24205472		92-	A	D3
R 7035	CHIP RES.	10k	1/16W	5%	RMC1/16 103JATP	J24185103		92-	A	C3
R 7036	CHIP RES.	2.2k	1/16W	5%	RMC1/16 222JATP	J24185222		92-	A	C3
R 7038	CHIP RES.	0	1/10W	5%	RMC1/10T 000J	J24205000		92-	A	D2
R 7039	CHIP RES.	0	1/10W	5%	RMC1/10T 000J	J24205000		92-	A	D2
R 7042	CHIP RES.	0	1/4W	5%	RMC1/4 000JATP	J24245000		92-	A	F2
TH7001	THERMISTOR				NT732ATD2.0K K	G9090079		92-	A	D2
	NYLON CLAMP				PLT-1M BK-1	S3000022		92-		
	NYLON CLAMP				PLT-1M BK-1	S3000022		92-		
	BINDING HEAD SCREW				M3X4	U20304001		92-		
	SHIELD CASE					RA0689900		92-		
	GROUND PLATE					RA069650A		92-		

PA-2 Unit (Lot. 92~)

Note:

Circuit Diagram

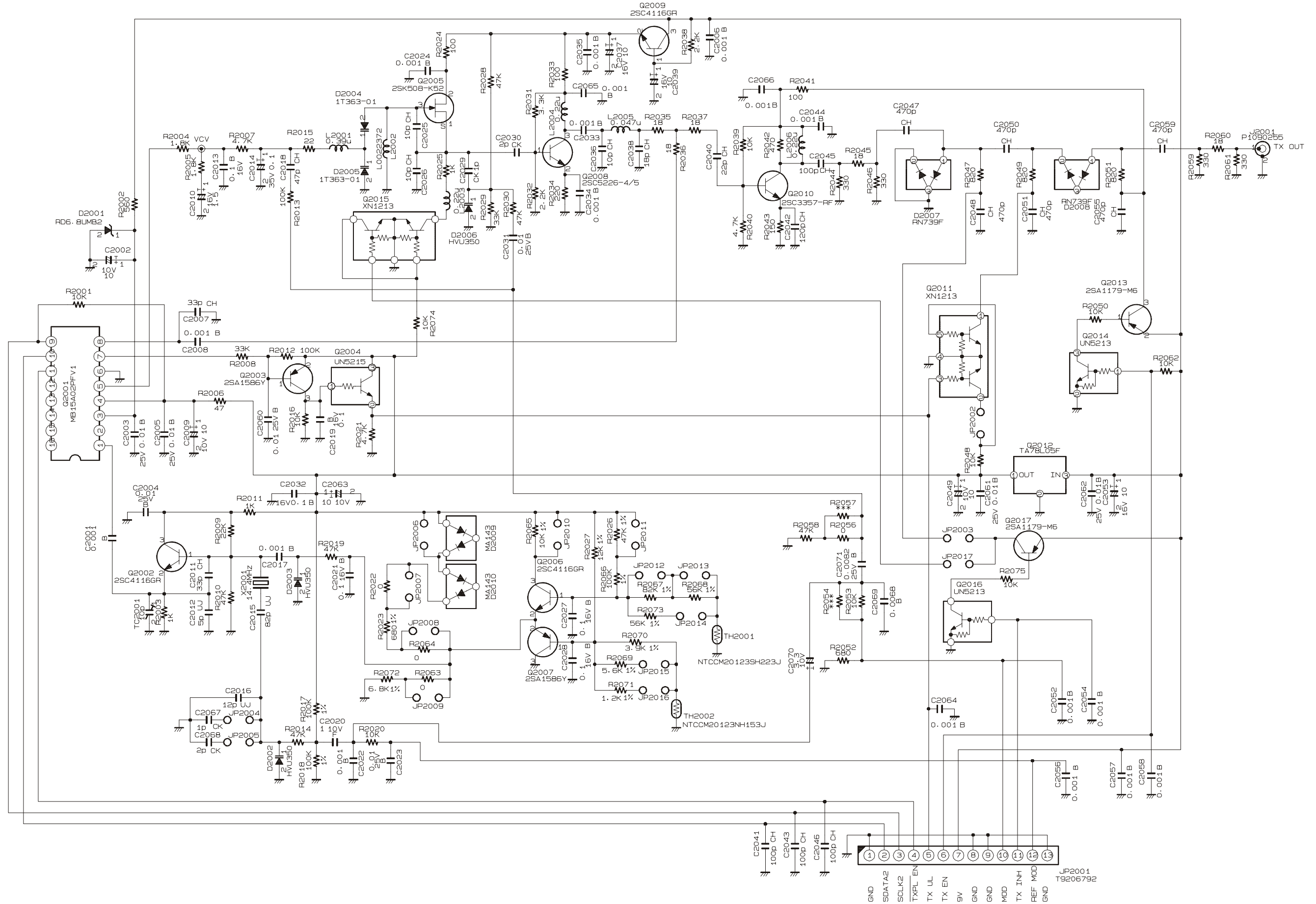

TX Unit (Lot. 1~)

Parts Layout

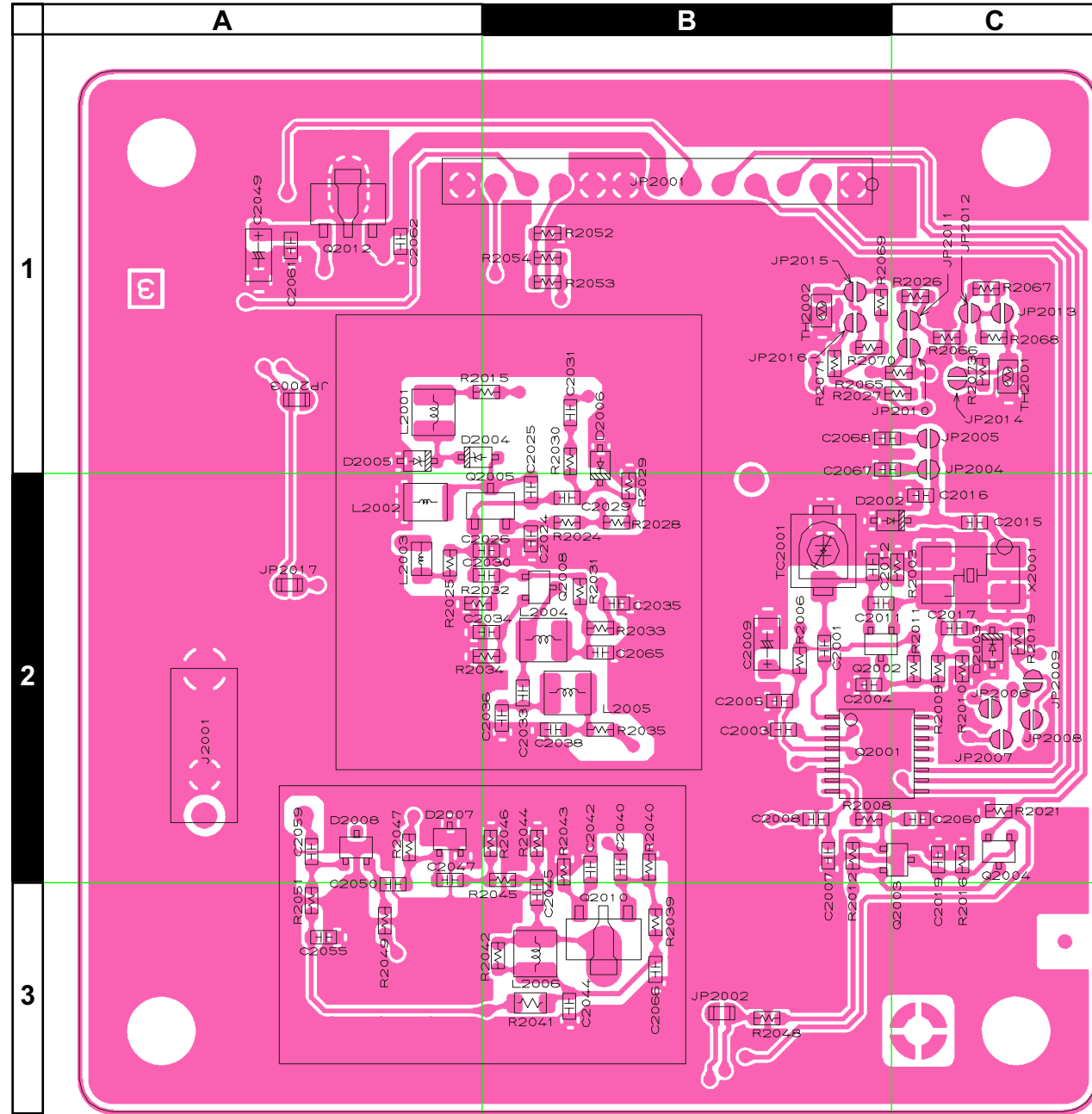

Side A

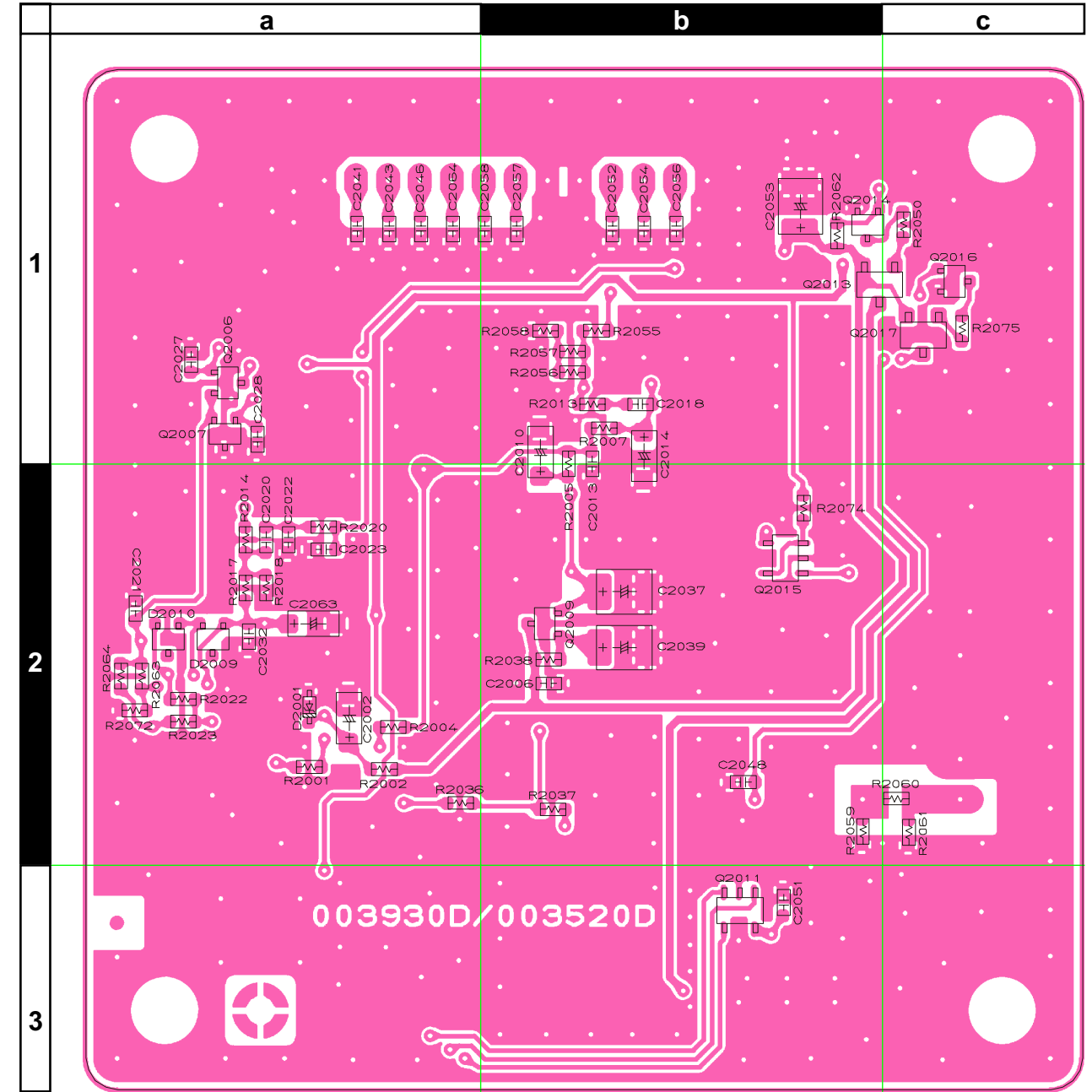

Side B

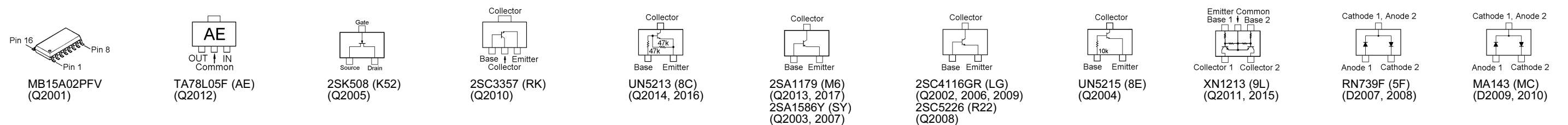

Circuit Diagram

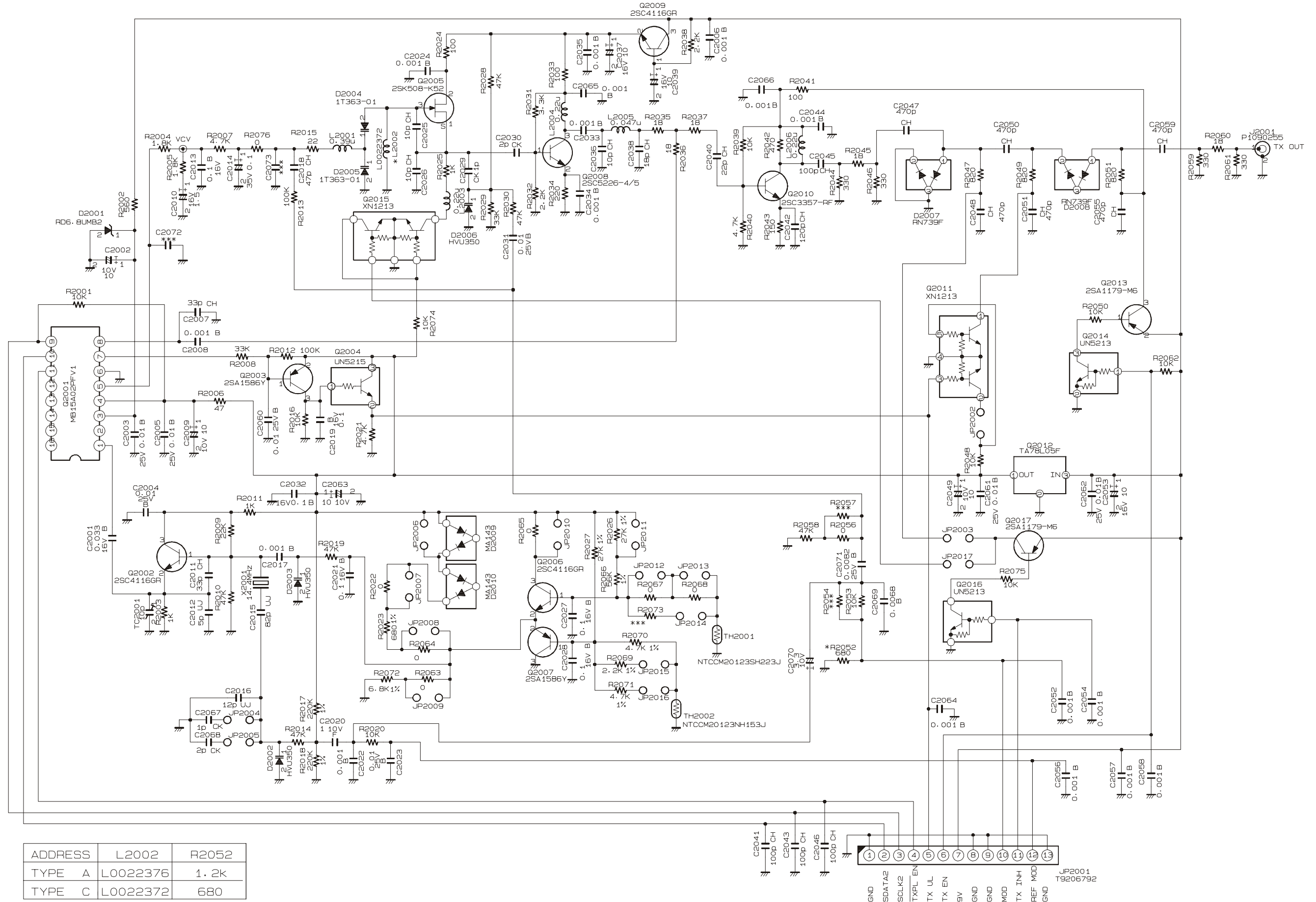

TX Unit (Lot. 6~)

Parts Layout

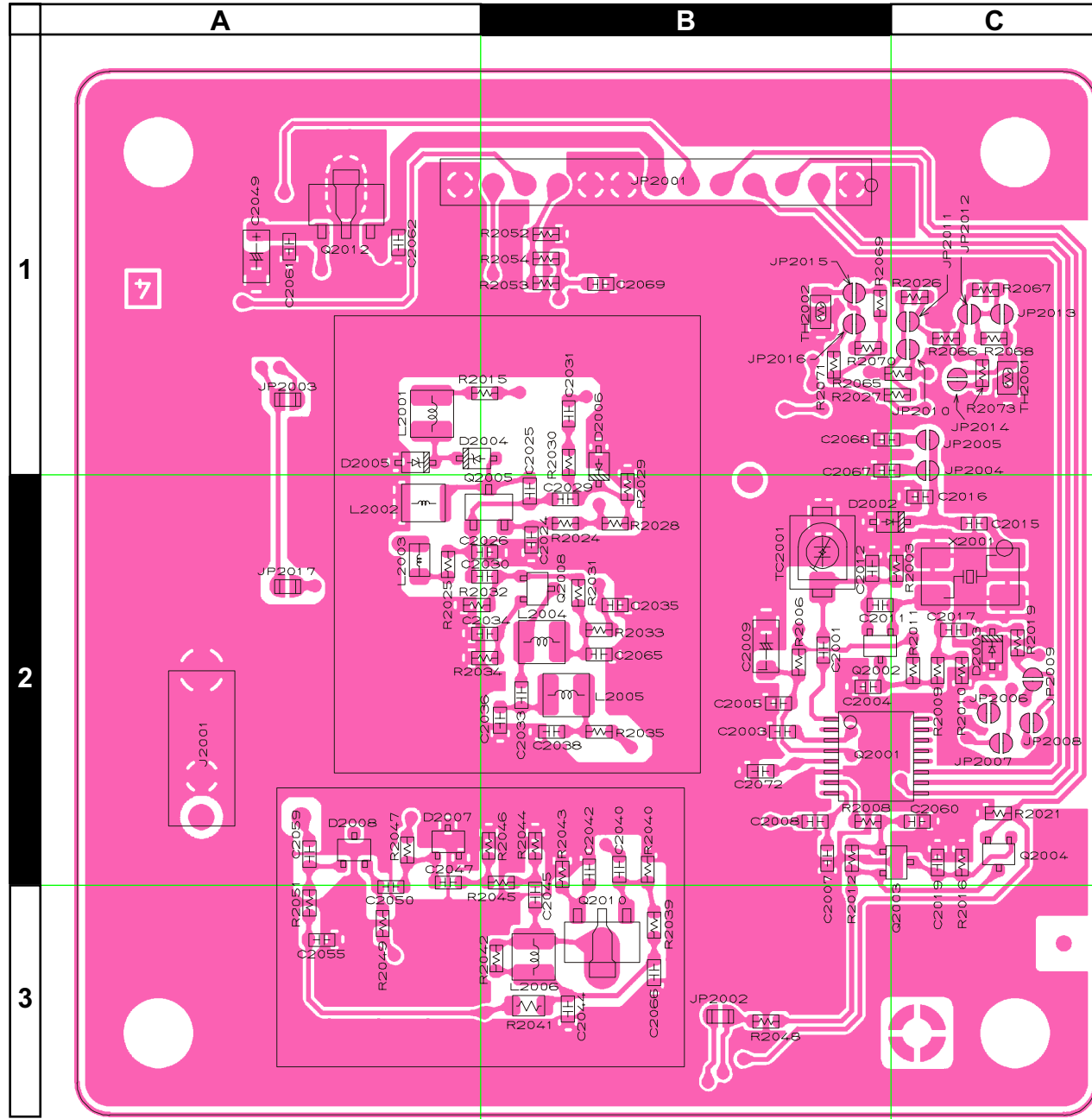

Side A

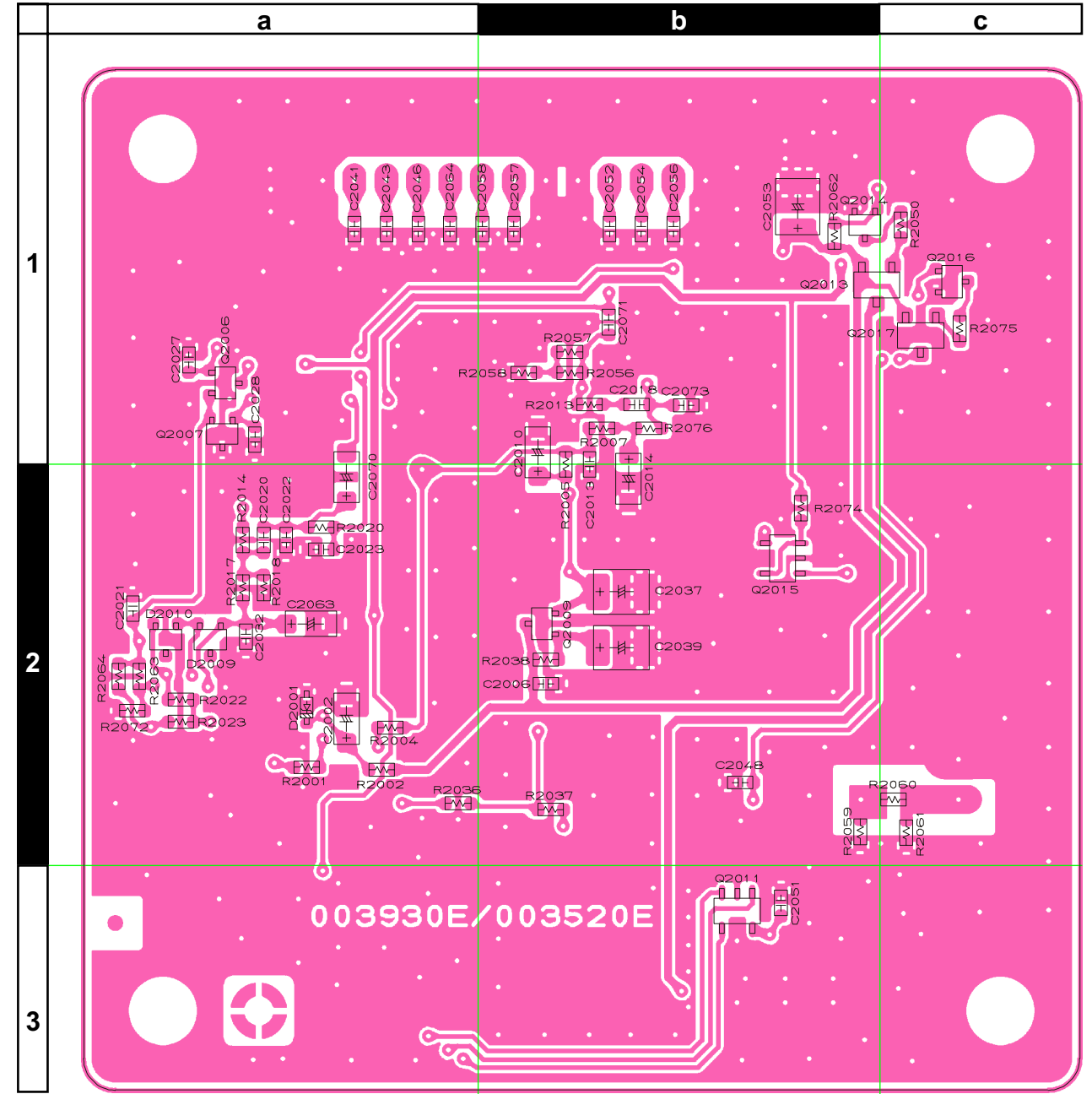

Side B

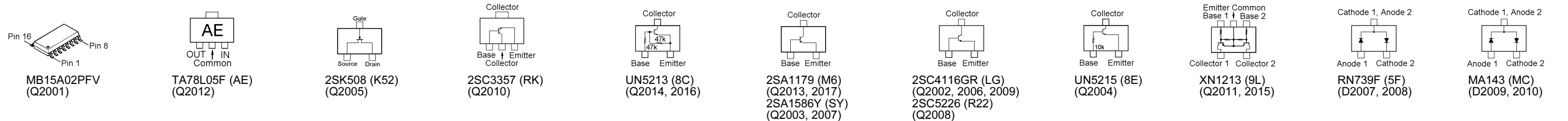

Parts List

REF.	DESCRIPTION	VALUE	V/W	TOL.	MFR'S DESIG	VXSTD P/N	VERS.	LOT.	SIDE	LAYADR
*** TX UNIT ***										
PCB with Components						CB0740001				
	Printed Circuit Board					FR003520D		1-		
	Printed Circuit Board					FR003520E		6-		
C 2001	CHIP CAP.	0.001uF	50V	B	GRM188B11H102KA01D	K22174821		1-	A	B2
C 2001	CHIP CAP.	0.033uF	16V	B	ECJ1VB1C333K	K22129515		7-	A	B2
C 2001	CHIP CAP.	0.1uF	16V	B	GRM188B11C104KA01D	K22124805		23-	A	B2
C 2002	CHIP TA.CAP.	10uF	10V		TEMSVA1A106M-8R	K78100028		1-	B	a2
C 2003	CHIP CAP.	0.01uF	25V	B	GRM39B103M25PT	K22144802		1-	A	B2
C 2004	CHIP CAP.	0.01uF	25V	B	GRM39B103M25PT	K22144802		1-	A	B2
C 2005	CHIP CAP.	0.01uF	25V	B	GRM39B103M25PT	K22144802		1-	A	B2
C 2006	CHIP CAP.	0.001uF	50V	B	GRM188B11H102KA01D	K22174821		1-	B	b2
C 2007	CHIP CAP.	33pF	50V	CH	GRM1882C1H330JA01D	K22174223		1-	A	B2
C 2008	CHIP CAP.	0.001uF	50V	B	GRM188B11H102KA01D	K22174821		1-	A	B2
C 2009	CHIP TA.CAP.	10uF	10V		TEMSVA1A106M-8R	K78100028		1-	A	B2
C 2010	CHIP TA.CAP.	1.5uF	16V		TESVA1C155M1-8R	K78120020		1-	B	b1
C 2011	CHIP CAP.	33pF	50V	CH	GRM1882C1H330JA01D	K22174223		1-	A	B2
C 2012	CHIP CAP.	5pF	50V	UJ	GRM1883U1H5R0CZ01D	K22174305		1-	A	B2
C 2013	CHIP CAP.	0.1uF	16V	B	GRM188B11C104KA01D	K22124805		1-	B	b1
C 2014	CHIP TA.CAP.	0.1uF	35V		TESVA1V104M1-8R	K78160025		1-	B	b2
C 2015	CHIP CAP.	82pF	50V	UJ	GRM1883U1H820JZ01D	K22174330		1-	A	C2
C 2016	CHIP CAP.	12pF	50V	UJ	GRM1883U1H120JZ01D	K22174302		1-	A	C2
C 2017	CHIP CAP.	0.001uF	50V	B	GRM188B11H102KA01D	K22174821		1-	A	C2
C 2018	CHIP CAP.	47pF	50V	CH	GRM1882C1H470JA01D	K22174227		1-	B	b1
C 2019	CHIP CAP.	0.1uF	16V	B	GRM188B11C104KA01D	K22124805		1-	A	C2
C 2020	CHIP CAP.	1uF	10V	F	GRM188F11A105ZA01D	K22105001		1-	B	a2
C 2021	CHIP CAP.	0.1uF	16V	B	GRM188B11C104KA01D	K22124805		1-	B	a2
C 2022	CHIP CAP.	0.001uF	50V	B	GRM188B11H102KA01D	K22174821		1-	B	a2
C 2023	CHIP CAP.	0.01uF	25V	B	GRM39B103M25PT	K22144802		1-	B	a2
C 2024	CHIP CAP.	0.001uF	50V	B	GRM188B11H102KA01D	K22174821		1-	A	B2
C 2025	CHIP CAP.	10pF	50V	CH	GRM1882C1H100JA01D	K22174211		1-	A	B2
C 2026	CHIP CAP.	10pF	50V	CH	GRM1882C1H100JA01D	K22174211		1-	A	B2
C 2027	CHIP CAP.	0.1uF	16V	B	GRM188B11C104KA01D	K22124805		1-	B	a1
C 2028	CHIP CAP.	0.1uF	16V	B	GRM188B11C104KA01D	K22124805		1-	B	a1
C 2029	CHIP CAP.	1pF	50V	CK	GRM1884C1H1R0CZ01D	K22174202		1-	A	B2
C 2030	CHIP CAP.	2pF	50V	CK	GRM1884C1H2R0CZ01D	K22174203		1-	A	B2
C 2031	CHIP CAP.	0.01uF	25V	B	GRM39B103M25PT	K22144802		1-	A	B1
C 2032	CHIP CAP.	0.1uF	16V	B	GRM188B11C104KA01D	K22124805		1-	B	a2
C 2033	CHIP CAP.	0.001uF	50V	B	GRM188B11H102KA01D	K22174821		1-18	A	B2
C 2033	CHIP CAP.	0.001uF	50V	B	GRM188B11H102KA01D	K22174821	VERSION A	38-	A	B2
C 2033	CHIP CAP.	0.001uF	50V	B	GRM188B11H102KA01D	K22174821	VERSION C	19-	A	B2
C 2033	CHIP CAP.	0.001uF	50V	B	GRM188B11H102KA01D	K22174821	VERSION A	19-37	A	B2
C 2034	CHIP CAP.	0.001uF	50V	B	GRM188B11H102KA01D	K22174821		1-	A	B2
C 2035	CHIP CAP.	0.001uF	50V	B	GRM188B11H102KA01D	K22174821		1-	A	B2
C 2036	CHIP CAP.	10pF	50V	CH	GRM1882C1H100JA01D	K22174211		1-	A	B2
C 2037	CHIP TA.CAP.	10uF	16V		TEMSVB21C106M-8R	K78120025		1-	B	b2
C 2038	CHIP CAP.	18pF	50V	CH	GRM1882C1H180JA01D	K22174217		1-	A	B2
C 2039	CHIP TA.CAP.	10uF	16V		TEMSVB21C106M-8R	K78120025		1-	B	b2
C 2040	CHIP CAP.	22pF	50V	CH	GRM1882C1H220JA01D	K22174219		1-	A	B2
C 2041	CHIP CAP.	100pF	50V	CH	GRM1882C1H101JA01D	K22174235		1-	B	a1
C 2042	CHIP CAP.	120pF	50V	CH	GRM1882C1H121JA01D	K22174237		1-	A	B2
C 2043	CHIP CAP.	100pF	50V	CH	GRM1882C1H101JA01D	K22174235		1-	B	a1
C 2044	CHIP CAP.	0.001uF	50V	B	GRM188B11H102KA01D	K22174821		1-	A	B3
C 2045	CHIP CAP.	100pF	50V	CH	GRM1882C1H101JA01D	K22174235		1-	A	B3
C 2046	CHIP CAP.	100pF	50V	CH	GRM1882C1H101JA01D	K22174235		1-	B	a1
C 2047	CHIP CAP.	470pF	50V	CH	GRM1882C1H471JA01D	K22174249		1-	A	A2
C 2048	CHIP CAP.	470pF	50V	CH	GRM1882C1H471JA01D	K22174249		1-	B	b2
C 2049	CHIP TA.CAP.	10uF	10V		TEMSVA1A106M-8R	K78100028		1-	A	A1
C 2050	CHIP CAP.	470pF	50V	CH	GRM1882C1H471JA01D	K22174249		1-	A	A3
C 2051	CHIP CAP.	470pF	50V	CH	GRM1882C1H471JA01D	K22174249		1-	B	b3

TX Unit

REF.	DESCRIPTION	VALUE	V/W	TOL.	MFR'S DESIG	VXSTD P/N	VERS.	LOT.	SIDE	LAYADR
C 2052	CHIP CAP.	0.001uF	50V	B	GRM188B11H102KA01D	K22174821		1-	B	b1
C 2053	CHIP TA.CAP.	10uF	16V		TEMSVB21C106M-8R	K78120025		1-	B	b1
C 2054	CHIP CAP.	0.001uF	50V	B	GRM188B11H102KA01D	K22174821		1-	B	b1
C 2055	CHIP CAP.	470pF	50V	CH	GRM1882C1H471JA01D	K22174249		1-	A	A3
C 2056	CHIP CAP.	0.001uF	50V	B	GRM188B11H102KA01D	K22174821		1-	B	b1
C 2057	CHIP CAP.	0.001uF	50V	B	GRM188B11H102KA01D	K22174821		1-	B	b1
C 2058	CHIP CAP.	0.001uF	50V	B	GRM188B11H102KA01D	K22174821		1-	B	b1
C 2059	CHIP CAP.	470pF	50V	CH	GRM1882C1H471JA01D	K22174249		1-	A	A2
C 2060	CHIP CAP.	0.01uF	25V	B	GRM39B103M25PT	K22144802		1-	A	C2
C 2061	CHIP CAP.	0.01uF	25V	B	GRM39B103M25PT	K22144802		1-	A	A1
C 2062	CHIP CAP.	0.01uF	25V	B	GRM39B103M25PT	K22144802		1-	A	A1
C 2063	CHIP TA.CAP.	10uF	10V		TEMSVA1A106M-8R	K78100028		1-	B	a2
C 2064	CHIP CAP.	0.001uF	50V	B	GRM188B11H102KA01D	K22174821		1-	B	a1
C 2065	CHIP CAP.	0.001uF	50V	B	GRM188B11H102KA01D	K22174821		1-	A	B2
C 2066	CHIP CAP.	0.001uF	50V	B	GRM188B11H102KA01D	K22174821		1-	A	B3
C 2067	CHIP CAP.	1pF	50V	CK	GRM1884C1H1R0CZ01D	K22174202		1-	A	B1
C 2068	CHIP CAP.	2pF	50V	CK	GRM1884C1H2R0CZ01D	K22174203		1-	A	B1
C 2069	CHIP CAP.	0.0068uF	50V	B	GRM188B11H682KA01D	K22174819		1-	A	B1
C 2070	TANTALUM CAP.	3.3uF	10V		TPDN1A3R3M8S(MX0)	K76100003		1-	B	a2
C 2070	CHIP TA.CAP.	3.3uF	10V		TEMSVA1A335M-8R	K78100015		3-	B	a2
C 2071	CHIP CAP.	0.0082uF	25V	B	GRM39B822M25PT	K22144801		1-	B	b1
D 2001	DIODE				RD6.8UMB2-T1B	G2070438		1-	B	a2
D 2002	DIODE				HVU350TRF	G2070380		1-	A	B2
D 2003	DIODE				HVU350TRF	G2070380		1-	A	C2
D 2004	DIODE				1T363-01-T8A	G2070114		1-	A	A1
D 2005	DIODE				1T363-01-T8A	G2070114		1-	A	A1
D 2006	DIODE				HVU350TRF	G2070380		1-	A	B1
D 2007	DIODE				RN739F T106	G2070626		1-	A	A2
D 2008	DIODE				RN739F T106	G2070626		1-	A	A2
D 2009	DIODE				MA143-(TX)	G2070536		1-	B	a2
D 2010	DIODE				MA143-(TX)	G2070536		1-	B	a2
J 2001	CONNECTOR				TMP-J01X-A2	P1090255		1-	A	A2
J 2001	CONNECTOR				TMP-S01X-C1	P1091254		88-	A	A2
JP2001	WIRE ASSY				A1367+	T9206792		1-	A	B1
L 2001	CHIP COIL	0.22uH			C2520C-R22J	L1690548		1	A	A1
L 2001	CHIP COIL	0.39uH			C2520C-R39J	L1690551		2-	A	A1
L 2002	COIL				E2 0.3-1.7-7T-R	L0022372		1-6	A	A2
L 2002	COIL				E2 0.3-1.7-8T-L	L0022376	VERSION A	7-	A	A2
L 2002	COIL				E2 0.3-1.7-7T-R	L0022372	VERSION C	7-	A	A2
L 2003	M.RFC	0.22uH			LK2125 R22K-T	L1690311		1-	A	A2
L 2004	CHIP COIL	0.22uH			C2520C-R22J	L1690548		1-	A	B2
L 2005	CHIP COIL	0.047uH			C2520C-47NK	L1690540		1-	A	B2
L 2006	CHIP COIL	0.22uH			C2520C-R22J	L1690548		1-	A	B3
Q 2001	IC				MB15A02PFV1-G-BND-EFE1	G1092541		1-	A	B2
Q 2002	TRANSISTOR				2SC4116GR TE85R	G3341167G		1-	A	B2
Q 2003	TRANSISTOR				2SA1586Y TE85R	G3115867Y		1-	A	C2
Q 2004	TRANSISTOR				UN5215-(TX)	G3070193		1-	A	C2
Q 2005	FET				2SK508-T2B K52	G3805087B		1-	A	B2
Q 2006	TRANSISTOR				2SC4116GR TE85R	G3341167G		1-	B	a1
Q 2007	TRANSISTOR				2SA1586Y TE85R	G3115867Y		1-	B	a1
Q 2008	TRANSISTOR				2SC5226-4/5-TL	G3352268Z		1-	A	B2
Q 2009	TRANSISTOR				2SC4116GR TE85R	G3341167G		1-	B	b2
Q 2010	TRANSISTOR				2SC3357-T2 RF	G3333577F		1-	A	B3
Q 2011	TRANSISTOR				XN1213-(TX)	G3070194		1-	B	b3
Q 2012	IC				TA78L05F TE12R	G1091014		1-	A	A1
Q 2013	TRANSISTOR				2SA1179M6-TA	G3111797F		1-	B	c1
Q 2014	TRANSISTOR				UN5213-(TX)	G3070192		1-	B	b1
Q 2015	TRANSISTOR				XN1213-(TX)	G3070194		1-	B	b2
Q 2016	TRANSISTOR				UN5213-(TX)	G3070192		1-	B	c1
Q 2017	TRANSISTOR				2SA1179M6-TA	G3111797F		1-	B	c1

REF.	DESCRIPTION	VALUE	V/W	TOL.	MFR'S DESIG	VXSTD P/N	VERS.	LOT.	SIDE	LAYADR
R 2001	CHIP RES.	10k	1/16W	5%	RMC1/16 103JATP	J24185103		1-	B	a2
R 2002	CHIP RES.	560	1/16W	5%	RMC1/16 561JATP	J24185561		1-	B	a2
R 2003	CHIP RES.	1k	1/16W	5%	RMC1/16 102JATP	J24185102		1-	A	C2
R 2004	CHIP RES.	1.8k	1/16W	5%	RMC1/16 182JATP	J24185182		1-	B	a2
R 2005	CHIP RES.	1.8k	1/16W	5%	RMC1/16 182JATP	J24185182		1-	B	b1
R 2006	CHIP RES.	47	1/16W	5%	RMC1/16 470JATP	J24185470		1-	A	B2
R 2007	CHIP RES.	4.7k	1/16W	5%	RMC1/16 472JATP	J24185472		1-	B	b1
R 2008	CHIP RES.	33k	1/16W	5%	RMC1/16 333JATP	J24185333		1-	A	B2
R 2009	CHIP RES.	22k	1/16W	5%	RMC1/16 223JATP	J24185223		1-	A	C2
R 2010	CHIP RES.	47k	1/16W	5%	RMC1/16 473JATP	J24185473		1-	A	C2
R 2011	CHIP RES.	1k	1/16W	5%	RMC1/16 102JATP	J24185102		1-	A	C2
R 2012	CHIP RES.	100k	1/16W	5%	RMC1/16 104JATP	J24185104		1-	A	B2
R 2013	CHIP RES.	100k	1/16W	5%	RMC1/16 104JATP	J24185104		1-	B	b1
R 2014	CHIP RES.	47k	1/16W	5%	RMC1/16 473JATP	J24185473		1-	B	a2
R 2015	CHIP RES.	22	1/16W	5%	RMC1/16 220JATP	J24185220		1-	A	B1
R 2016	CHIP RES.	10k	1/16W	5%	RMC1/16 103JATP	J24185103		1-	A	C2
R 2017	CHIP RES.	100k	1/16W	1%	RMC1/16 104FTP	J24183104		1-	B	a2
R 2017	CHIP RES.	220k	1/16W	1%	RMC1/16 224FTP	J24183224		7-	B	a2
R 2018	CHIP RES.	100k	1/16W	1%	RMC1/16 104FTP	J24183104		1-	B	a2
R 2018	CHIP RES.	220k	1/16W	1%	RMC1/16 224FTP	J24183224		7-	B	a2
R 2019	CHIP RES.	47k	1/16W	5%	RMC1/16 473JATP	J24185473		1-	A	C2
R 2020	CHIP RES.	10k	1/16W	5%	RMC1/16 103JATP	J24185103		1-	B	a2
R 2021	CHIP RES.	4.7k	1/16W	5%	RMC1/16 472JATP	J24185472		1-	A	C2
R 2022	CHIP RES.	0	1/16W	5%	RMC1/16 000JATP	J24185000		1-	B	a2
R 2023	CHIP RES.	680	1/16W	1%	RMC1/16 681FTP	J24183681		1-	B	a2
R 2024	CHIP RES.	100	1/16W	5%	RMC1/16 101JATP	J24185101		1-	A	B2
R 2025	CHIP RES.	1k	1/16W	5%	RMC1/16 102JATP	J24185102		1-	A	A2
R 2026	CHIP RES.	47k	1/16W	1%	RMC1/16 473FTP	J24183473		1-	A	C1
R 2026	CHIP RES.	27k	1/16W	1%	RMC1/16 273FTP	J24183273		6-	A	C1
R 2027	CHIP RES.	12k	1/16W	1%	RMC1/16 123FTP	J24183123		1-	A	C1
R 2027	CHIP RES.	27k	1/16W	1%	RMC1/16 273FTP	J24183273		6-	A	C1
R 2028	CHIP RES.	47k	1/16W	5%	RMC1/16 473JATP	J24185473		1-	A	B2
R 2029	CHIP RES.	33k	1/16W	5%	RMC1/16 333JATP	J24185333		1-	A	B2
R 2030	CHIP RES.	47k	1/16W	5%	RMC1/16 473JATP	J24185473		1-	A	B1
R 2031	CHIP RES.	3.3k	1/16W	5%	RMC1/16 332JATP	J24185332		1-	A	B2
R 2032	CHIP RES.	2.2k	1/16W	5%	RMC1/16 222JATP	J24185222		1-	A	A2
R 2033	CHIP RES.	100	1/16W	5%	RMC1/16 101JATP	J24185101		1-	A	B2
R 2034	CHIP RES.	220	1/16W	5%	RMC1/16 221JATP	J24185221		1-	A	B2
R 2035	CHIP RES.	18	1/16W	5%	RMC1/16 180JATP	J24185180		1-	A	B2
R 2036	CHIP RES.	18	1/16W	5%	RMC1/16 180JATP	J24185180		1-	B	a2
R 2037	CHIP RES.	18	1/16W	5%	RMC1/16 180JATP	J24185180		1-	B	b2
R 2038	CHIP RES.	2.2k	1/16W	5%	RMC1/16 222JATP	J24185222		1-	B	b2
R 2039	CHIP RES.	10k	1/16W	5%	RMC1/16 103JATP	J24185103		1-	A	B3
R 2040	CHIP RES.	4.7k	1/16W	5%	RMC1/16 472JATP	J24185472		1-	A	B2
R 2041	CHIP RES.	100	1/10W	5%	RMC1/10T 101J	J24205101		1-	A	B3
R 2042	CHIP RES.	470	1/16W	5%	RMC1/16 471JATP	J24185471		1-	A	B3
R 2043	CHIP RES.	150	1/16W	5%	RMC1/16 151JATP	J24185151		1-	A	B2
R 2044	CHIP RES.	330	1/16W	5%	RMC1/16 331JATP	J24185331		1-	A	B2
R 2045	CHIP RES.	18	1/16W	5%	RMC1/16 180JATP	J24185180		1-	A	B2
R 2046	CHIP RES.	330	1/16W	5%	RMC1/16 331JATP	J24185331		1-	A	B2
R 2047	CHIP RES.	820	1/16W	5%	RMC1/16 821JATP	J24185821		1-	A	A2
R 2048	CHIP RES.	10k	1/16W	5%	RMC1/16 103JATP	J24185103		1-	A	B3
R 2049	CHIP RES.	820	1/16W	5%	RMC1/16 821JATP	J24185821		1-	A	A3
R 2050	CHIP RES.	10k	1/16W	5%	RMC1/16 103JATP	J24185103		1-	B	c1
R 2051	CHIP RES.	820	1/16W	5%	RMC1/16 821JATP	J24185821		1-	A	A3
R 2052	CHIP RES.	680	1/16W	5%	RMC1/16 681JATP	J24185681		1-6	A	B1
R 2052	CHIP RES.	1.2k	1/16W	5%	RMC1/16 122JATP	J24185122	VERSION A	7-	A	B1
R 2052	CHIP RES.	680	1/16W	5%	RMC1/16 681JATP	J24185681	VERSION C	7-	A	B1
R 2053	CHIP RES.	10k	1/16W	5%	RMC1/16 103JATP	J24185103		1-	A	B1
R 2056	CHIP RES.	0	1/16W	5%	RMC1/16 000JATP	J24185000		1-	B	b1

TX Unit

REF.	DESCRIPTION	VALUE	V/W	TOL.	MFR'S DESIG	VXSTD P/N	VERS.	LOT.	SIDE	LAYADR
R 2058	CHIP RES.	47k	1/16W	5%	RMC1/16 473JATP	J24185473		1-	B	b1
R 2059	CHIP RES.	330	1/16W	5%	RMC1/16 331JATP	J24185331		1-	B	b2
R 2060	CHIP RES.	18	1/16W	5%	RMC1/16 180JATP	J24185180		1-	B	c2
R 2061	CHIP RES.	330	1/16W	5%	RMC1/16 331JATP	J24185331		1-	B	c2
R 2062	CHIP RES.	10k	1/16W	5%	RMC1/16 103JATP	J24185103		1-	B	b1
R 2063	CHIP RES.	0	1/16W	5%	RMC1/16 000JATP	J24185000		1-	B	a2
R 2064	CHIP RES.	0	1/16W	5%	RMC1/16 000JATP	J24185000		1-	B	a2
R 2065	CHIP RES.	10k	1/16W	1%	RMC1/16 103FTP	J24183103		1-	A	C1
R 2065	CHIP RES.	0	1/16W	5%	RMC1/16 000JATP	J24185000		6-	A	C1
R 2066	CHIP RES.	100k	1/16W	1%	RMC1/16 104FTP	J24183104		1-	A	C1
R 2066	CHIP RES.	56k	1/16W	1%	RMC1/16 563FTP	J24183563		6-	A	C1
R 2067	CHIP RES.	82k	1/16W	1%	RMC1/16 823FTP	J24183823		1-	A	C1
R 2067	CHIP RES.	0	1/16W	5%	RMC1/16 000JATP	J24185000		6-	A	C1
R 2068	CHIP RES.	56k	1/16W	1%	RMC1/16 563FTP	J24183563		1-	A	C1
R 2068	CHIP RES.	0	1/16W	5%	RMC1/16 000JATP	J24185000		6-	A	C1
R 2069	CHIP RES.	5.6k	1/16W	1%	RMC1/16 562FTP	J24183562		1-	A	B1
R 2069	CHIP RES.	2.2k	1/16W	1%	RMC1/16 222FTP	J24183222		6-	A	B1
R 2070	CHIP RES.	3.9k	1/16W	1%	RMC1/16 392FTP	J24183392		1-	A	B1
R 2070	CHIP RES.	4.7k	1/16W	1%	RMC1/16 472FTP	J24183472		6-	A	B1
R 2071	CHIP RES.	1.2k	1/16W	1%	RMC1/16 122FTP	J24183122		1-	A	B1
R 2071	CHIP RES.	4.7k	1/16W	1%	RMC1/16 472FTP	J24183472		6-	A	B1
R 2072	CHIP RES.	6.8k	1/16W	1%	RMC1/16 682FTP	J24183682		1-	B	a2
R 2073	CHIP RES.	56k	1/16W	1%	RMC1/16 563FTP	J24183563		1-5	A	C1
R 2074	CHIP RES.	10k	1/16W	5%	RMC1/16 103JATP	J24185103		1-	B	b2
R 2075	CHIP RES.	10k	1/16W	5%	RMC1/16 103JATP	J24185103		1-	B	c1
R 2076	CHIP RES.	0	1/16W	5%	RMC1/16 000JATP	J24185000		6-	B	b1
TC2001	TRIMMER CAP.	10pF			ECR-JA010A11X	K91000227		1-	A	B2
TH2001	THERMISTOR				NTCCM20123SH223JCT	G9090106		1-	A	C1
TH2002	THERMISTOR				NTCCM20123NH153JCT	G9090105		1-	A	B1
X 2001	XTAL TOP-B	14.4MHz			14.4MHZ	H0103221		1-	A	C2
	SHIELD CASE					RA0014300		1-		
	SHIELD CASE				VCO	R0151950		1-		

Circuit Diagram

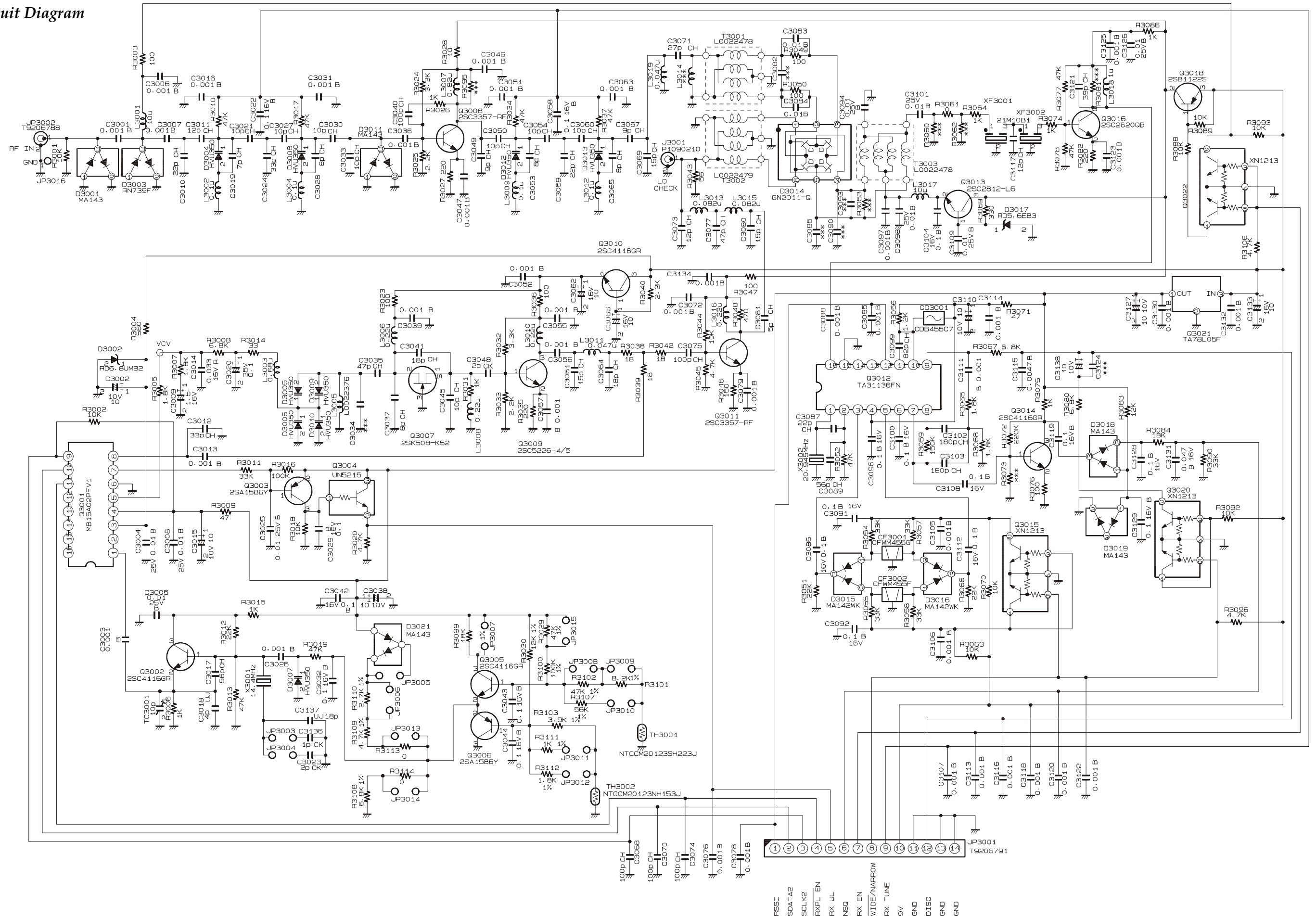

RX Unit (Lot. 1~)

Parts Layout

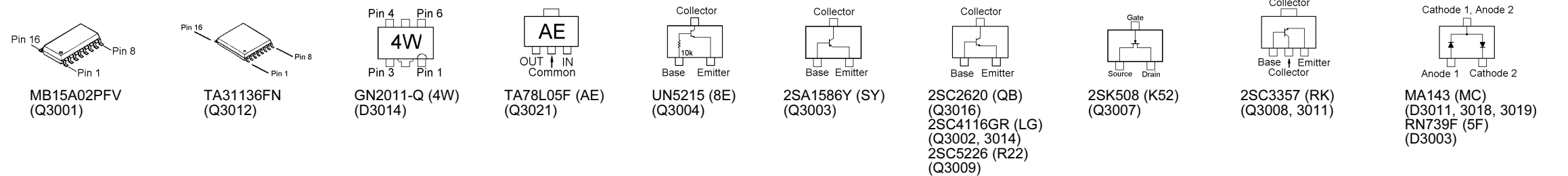
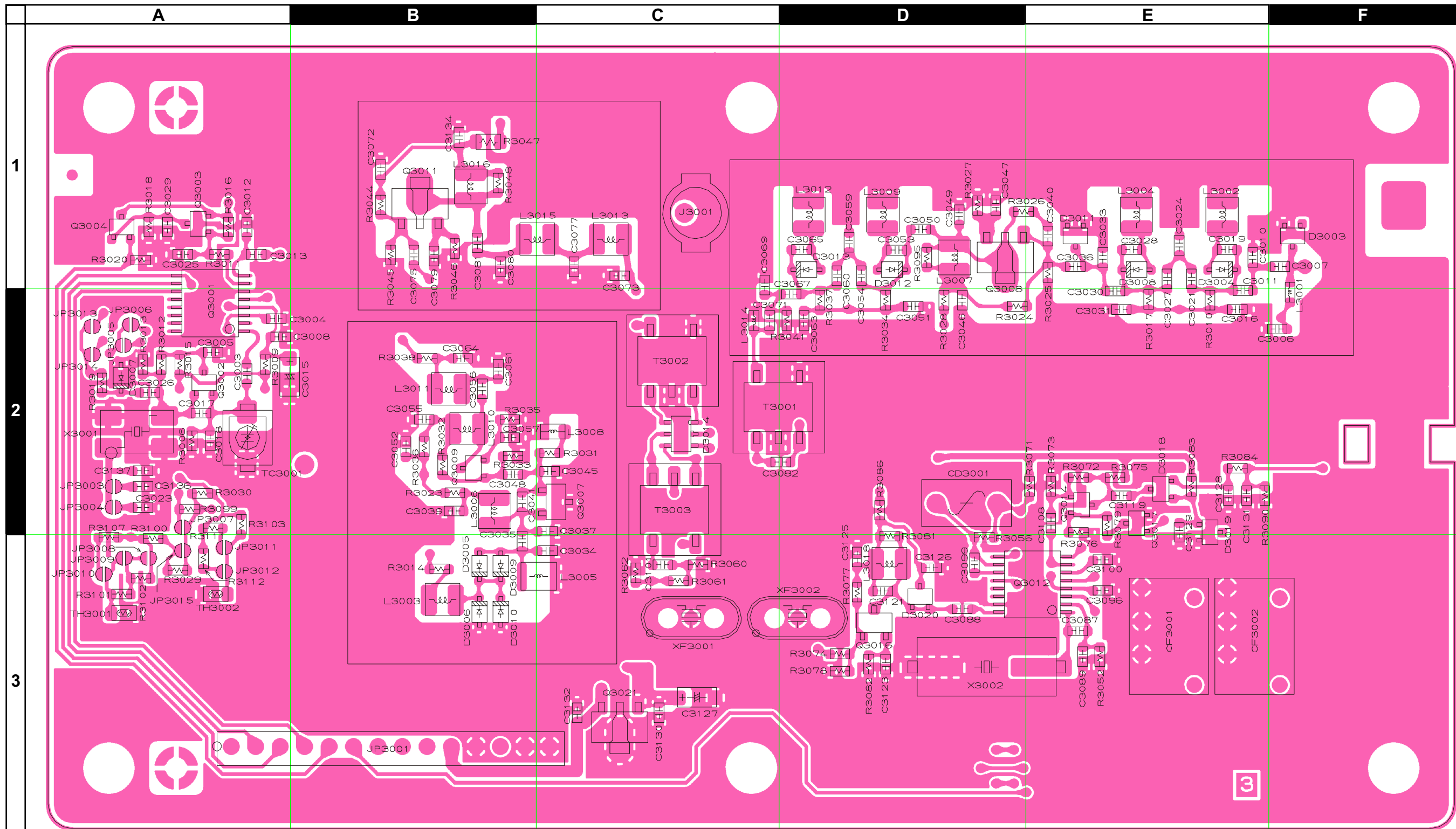

Side A

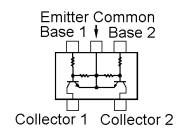
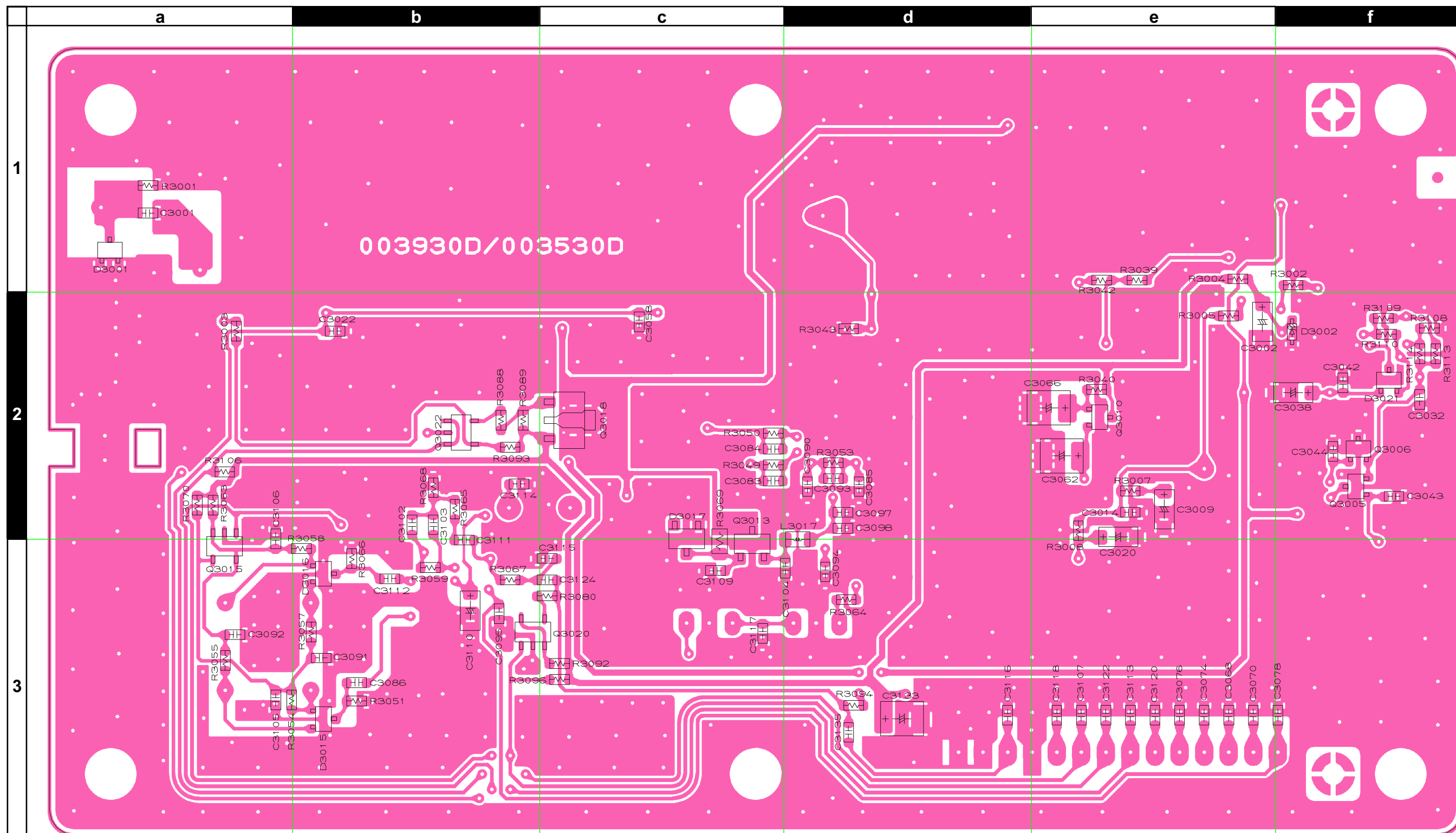

XN1213 (9L)
(Q3015, 3020, 3022)

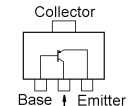

2SB1122S (BE)
(Q3018)

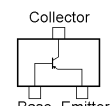

2SA1586Y (SY)
(Q3006)

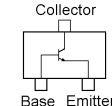

2SC2812 (L6)
(Q3013)
2SC4116GR (LG)
(Q3005, 3010)

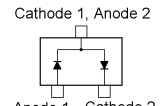

MA143 (MC)
(D3001, 3021)

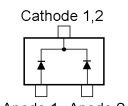

MA142WK (MU)
(D3015, 3016)

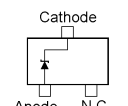

HZM5.6NB2 (562)
(D3017)

Side B

RX Unit (Lot. 6~)

Circuit Diagram

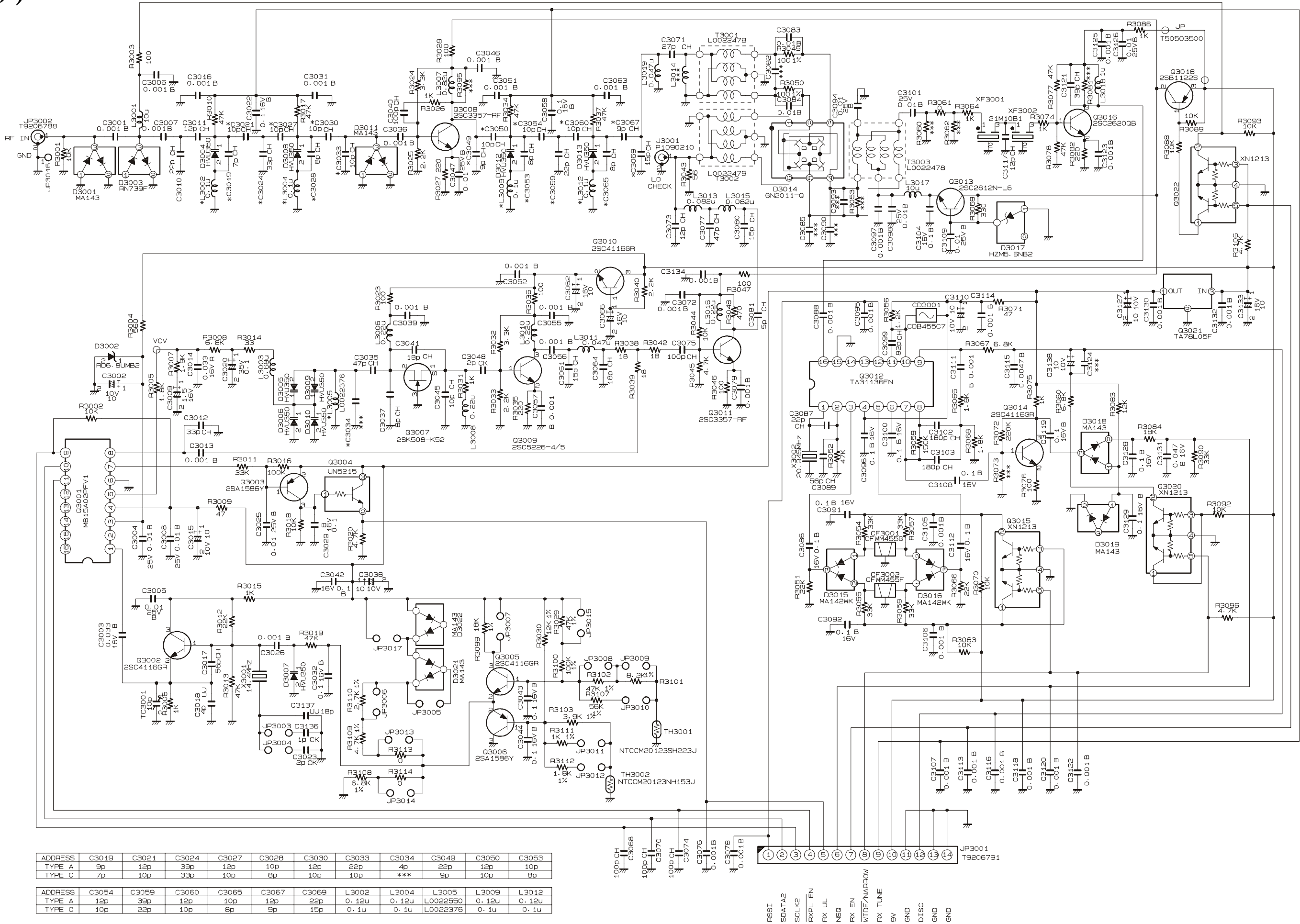

Parts Layout

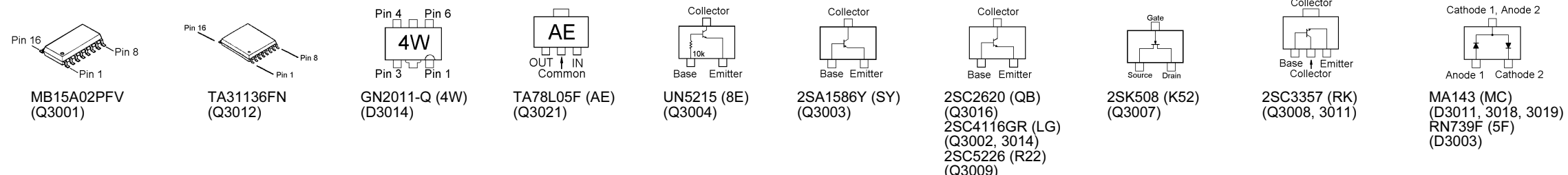
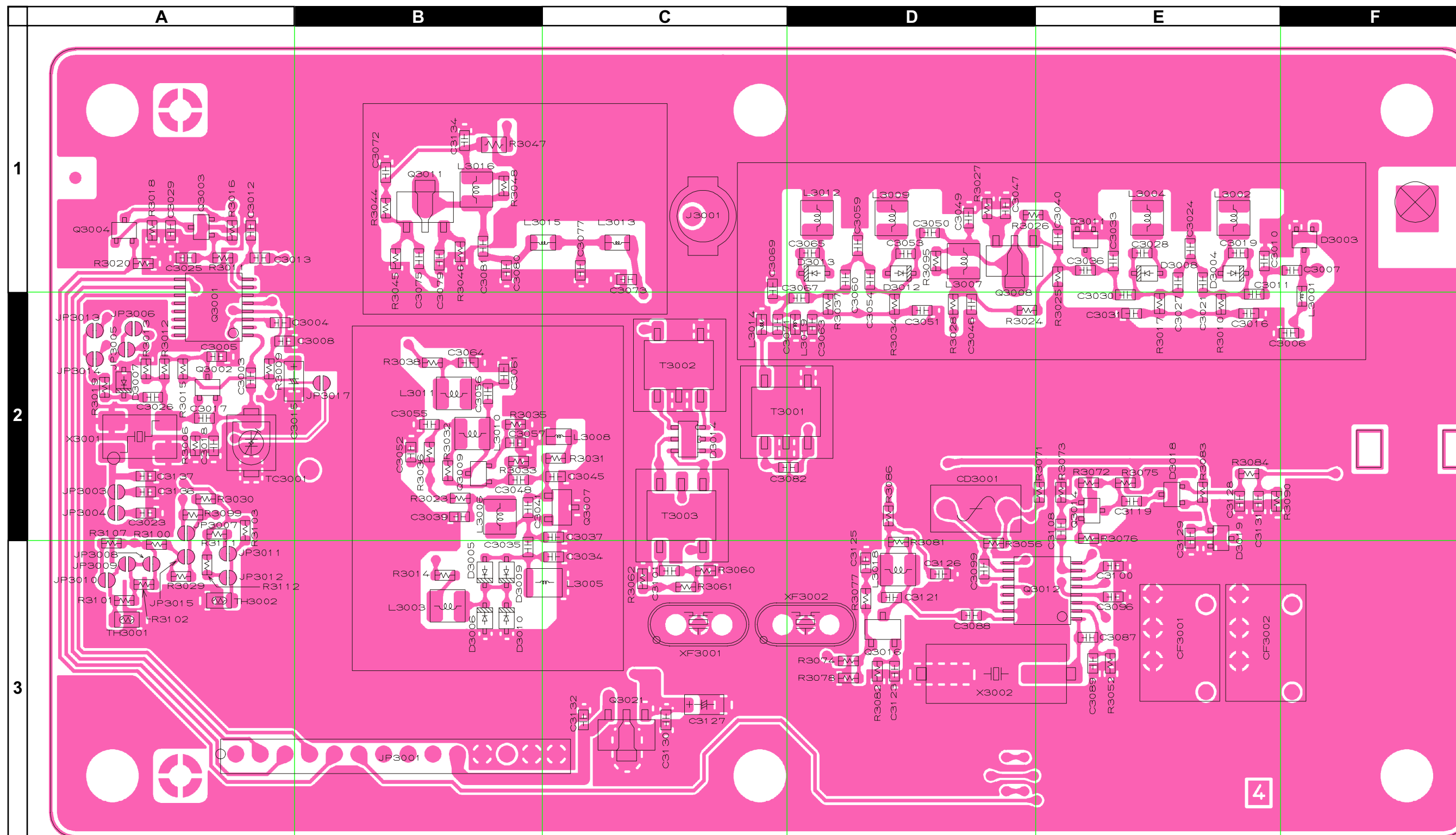

Side A

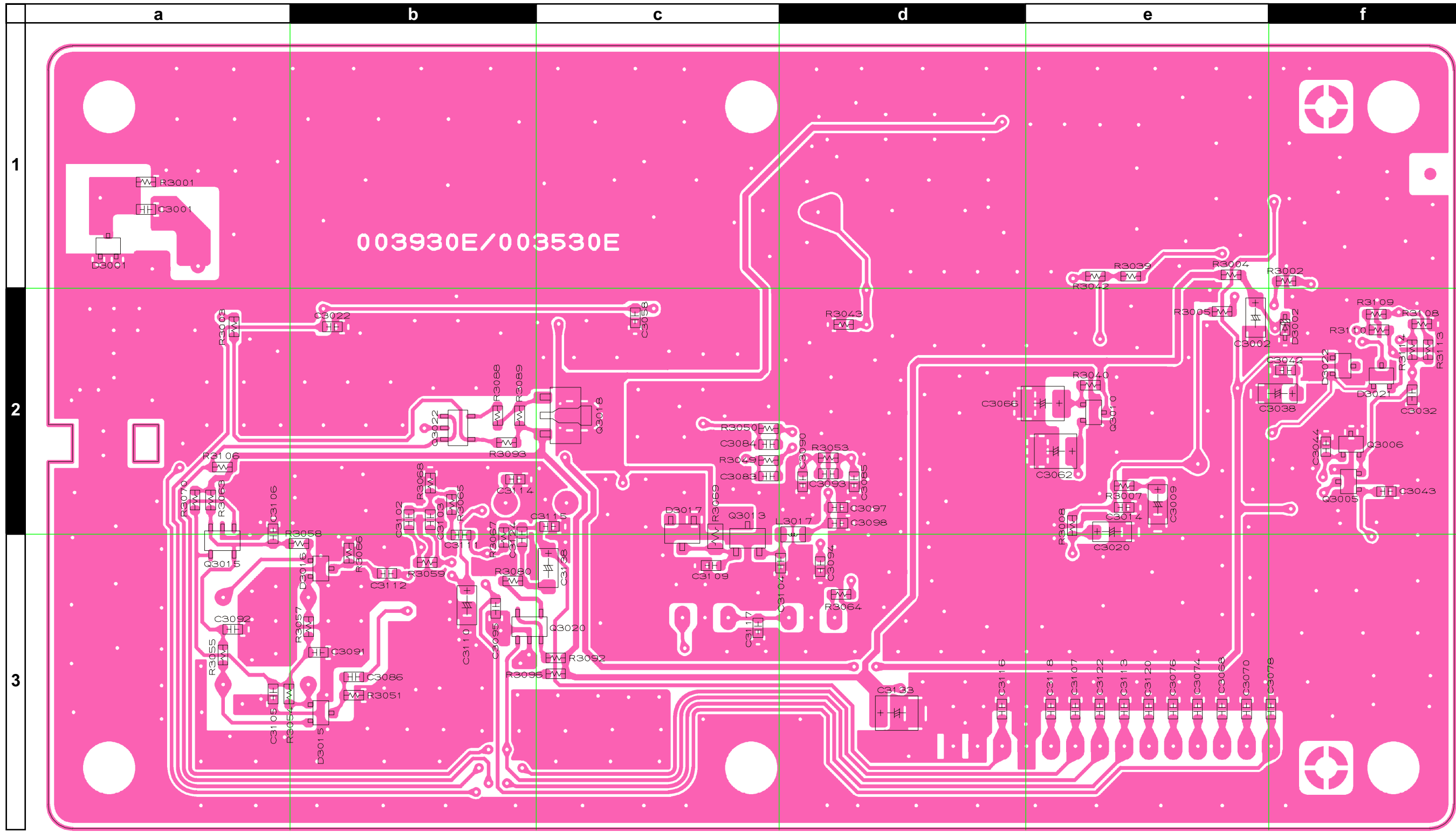

003930E/003530E

Side B

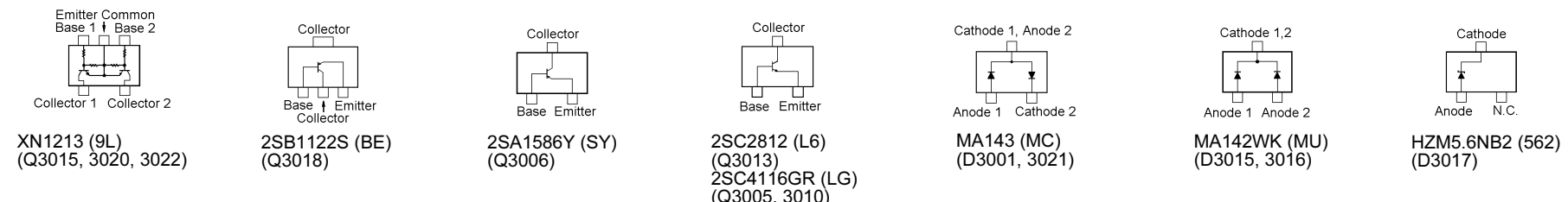

Parts List

REF.	DESCRIPTION	VALUE	V/W	TOL.	MFR'S DESIG	VXSTD P/N	VERS.	LOT.	SIDE	LAYADR
*** RX UNIT ***										
PCB with Components						CB0741001	VERSION C			
PCB with Components						CB0741002	VERSION A			
	Printed Circuit Board					FR003530D		1-		
	Printed Circuit Board					FR003530E		6-		
C 3001	CHIP CAP.	0.001uF	50V	B	GRM188B11H102KA01D	K22174821		1-	B	a1
C 3002	CHIP TA.CAP.	10uF	10V		TEMSVA1A106M-8R	K78100028		1-	B	e2
C 3003	CHIP CAP.	0.001uF	50V	B	GRM188B11H102KA01D	K22174821		1-	A	A2
C 3003	CHIP CAP.	0.033uF	16V	B	ECJ1VB1C333K	K22129515		7-	A	A2
C 3003	CHIP CAP.	0.1uF	16V	B	GRM188B11C104KA01D	K22124805		23-	A	A2
C 3004	CHIP CAP.	0.01uF	25V	B	GRM39B103M25PT	K22144802		1-	A	A2
C 3005	CHIP CAP.	0.01uF	25V	B	GRM39B103M25PT	K22144802		1-	A	A2
C 3006	CHIP CAP.	0.001uF	50V	B	GRM188B11H102KA01D	K22174821		1-	A	F2
C 3007	CHIP CAP.	0.001uF	50V	B	GRM188B11H102KA01D	K22174821		1-	A	F1
C 3008	CHIP CAP.	0.01uF	25V	B	GRM39B103M25PT	K22144802		1-	A	A2
C 3009	CHIP TA.CAP.	1.5uF	16V		TESVA1C155M1-8R	K78120020		1-	B	e2
C 3010	CHIP CAP.	22pF	50V	CH	GRM1882C1H220JA01D	K22174219		1-	A	E1
C 3011	CHIP CAP.	12pF	50V	CH	GRM1882C1H120JA01D	K22174213		1-	A	E1
C 3012	CHIP CAP.	33pF	50V	CH	GRM1882C1H330JA01D	K22174223		1-	A	A1
C 3013	CHIP CAP.	0.001uF	50V	B	GRM188B11H102KA01D	K22174821		1-	A	A1
C 3014	CHIP CAP.	0.033uF	16V	R	GRM188R11C333KA01D	K22124801		1-	B	e2
C 3015	CHIP TA.CAP.	10uF	10V		TEMSVA1A106M-8R	K78100028		1-	A	A2
C 3016	CHIP CAP.	0.001uF	50V	B	GRM188B11H102KA01D	K22174821		1-	A	E2
C 3017	CHIP CAP.	56pF	50V	CH	GRM1882C1H560JA01D	K22174229		1-	A	A2
C 3018	CHIP CAP.	4pF	50V	UJ	GRM1883U1H4R0CZ01D	K22174304		1-	A	A2
C 3019	CHIP CAP.	7pF	50V	CH	GRM1882C1H7R0DZ01D	K22174208		1-6	A	E1
C 3019	CHIP CAP.	9pF	50V	CH	GRM1882C1H9R0CZ01D	K22174247	VERSION A	7	A	E1
C 3019	CHIP CAP.	9pF	50V	CH	GRM1882C1H9R0DZ01D	K22174210	VERSION A	8-	A	E1
C 3019	CHIP CAP.	7pF	50V	CH	GRM1882C1H7R0DZ01D	K22174208	VERSION C	7-	A	E1
C 3020	CHIP TA.CAP.	0.1uF	35V		TESVA1V104M1-8R	K78160025		1-	B	e2
C 3021	CHIP CAP.	10pF	50V	CH	GRM1882C1H100JA01D	K22174211		1-6	A	E1
C 3021	CHIP CAP.	12pF	50V	CH	GRM1882C1H120JA01D	K22174213	VERSION A	7-	A	E1
C 3021	CHIP CAP.	10pF	50V	CH	GRM1882C1H100JA01D	K22174211	VERSION C	7-	A	E1
C 3022	CHIP CAP.	0.1uF	16V	B	GRM188B11C104KA01D	K22124805		1-	B	b2
C 3023	CHIP CAP.	2pF	50V	CK	GRM1884C1H2R0CZ01D	K22174203		1-	A	A2
C 3024	CHIP CAP.	33pF	50V	CH	GRM1882C1H330JA01D	K22174223		1-6	A	E1
C 3024	CHIP CAP.	39pF	50V	CH	GRM1882C1H390JA01D	K22174225	VERSION A	7-	A	E1
C 3024	CHIP CAP.	33pF	50V	CH	GRM1882C1H330JA01D	K22174223	VERSION C	7-	A	E1
C 3025	CHIP CAP.	0.01uF	25V	B	GRM39B103M25PT	K22144802		1-	A	A1
C 3026	CHIP CAP.	0.001uF	50V	B	GRM188B11H102KA01D	K22174821		1-	A	A2
C 3027	CHIP CAP.	10pF	50V	CH	GRM1882C1H100JA01D	K22174211		1-6	A	E1
C 3027	CHIP CAP.	12pF	50V	CH	GRM1882C1H120JA01D	K22174213	VERSION A	7-	A	E1
C 3027	CHIP CAP.	10pF	50V	CH	GRM1882C1H100JA01D	K22174211	VERSION C	7-	A	E1
C 3028	CHIP CAP.	8pF	50V	CH	GRM1882C1H8R0CZ01D	K22174246		1-6	A	E1
C 3028	CHIP CAP.	10pF	50V	CH	GRM1882C1H100JA01D	K22174211	VERSION A	7-	A	E1
C 3028	CHIP CAP.	8pF	50V	CH	GRM1882C1H8R0CZ01D	K22174246	VERSION C	7-	A	E1
C 3029	CHIP CAP.	0.1uF	16V	B	GRM188B11C104KA01D	K22124805		1-	A	A1
C 3030	CHIP CAP.	10pF	50V	CH	GRM1882C1H100JA01D	K22174211		1-6	A	E2
C 3030	CHIP CAP.	12pF	50V	CH	GRM1882C1H120JA01D	K22174213	VERSION A	7-	A	E2
C 3030	CHIP CAP.	10pF	50V	CH	GRM1882C1H100JA01D	K22174211	VERSION C	7-	A	E2
C 3031	CHIP CAP.	0.001uF	50V	B	GRM188B11H102KA01D	K22174821		1-	A	E2
C 3032	CHIP CAP.	0.1uF	16V	B	GRM188B11C104KA01D	K22124805		1-	B	f2
C 3033	CHIP CAP.	10pF	50V	CH	GRM1882C1H100JA01D	K22174211		1-6	A	E1
C 3033	CHIP CAP.	22pF	50V	CH	GRM1882C1H220JA01D	K22174219	VERSION A	7-	A	E1
C 3033	CHIP CAP.	10pF	50V	CH	GRM1882C1H100JA01D	K22174211	VERSION C	7-	A	E1
C 3034	CHIP CAP.	4pF	50V	CH	GRM1882C1H4R0CZ01D	K22174205	VERSION A	7-	A	C3
C 3035	CHIP CAP.	47pF	50V	CH	GRM1882C1H470JA01D	K22174227		1-	A	B3
C 3036	CHIP CAP.	0.001uF	50V	B	GRM188B11H102KA01D	K22174821		1-	A	E1
C 3037	CHIP CAP.	8pF	50V	CH	GRM1882C1H8R0DZ01D	K22174209		1-	A	C2
C 3038	CHIP TA.CAP.	10uF	10V		TEMSVA1A106M-8R	K78100028		1-	B	f2
C 3039	CHIP CAP.	0.001uF	50V	B	GRM188B11H102KA01D	K22174821		1-	A	B2
C 3040	CHIP CAP.	100pF	50V	CH	GRM1882C1H101JA01D	K22174235		1-	A	E1

RX Unit

REF.	DESCRIPTION	VALUE	V/W	TOL.	MFR'S DESIG	VXSTD P/N	VERS.	LOT.	SIDE	LAYADR
C 3041	CHIP CAP.	18pF	50V	CH	GRM1882C1H180JA01D	K22174217		1-	A	B2
C 3042	CHIP CAP.	0.1uF	16V	B	GRM188B11C104KA01D	K22124805		1-	B	f2
C 3043	CHIP CAP.	0.1uF	16V	B	GRM188B11C104KA01D	K22124805		1-	B	f2
C 3044	CHIP CAP.	0.1uF	16V	B	GRM188B11C104KA01D	K22124805		1-	B	f2
C 3045	CHIP CAP.	10pF	50V	CH	GRM1882C1H100JA01D	K22174211		1-	A	C2
C 3046	CHIP CAP.	0.001uF	50V	B	GRM188B11H102KA01D	K22174821		1-	A	D2
C 3047	CHIP CAP.	0.001uF	50V	B	GRM188B11H102KA01D	K22174821		1-	A	D1
C 3047	CHIP CAP.	0.01uF	25V	B	GRM39B103M25PT	K22144802		11-	A	D1
C 3048	CHIP CAP.	2pF	50V	CK	GRM1884C1H2R0CZ01D	K22174203		1-	A	B2
C 3049	CHIP CAP.	9pF	50V	CH	GRM1882C1H9R0DZ01D	K22174210		1-6	A	D1
C 3049	CHIP CAP.	22pF	50V	CH	GRM1882C1H220JA01D	K22174219	VERSION A	7-	A	D1
C 3049	CHIP CAP.	9pF	50V	CH	GRM1882C1H9R0DZ01D	K22174210	VERSION C	7-	A	D1
C 3050	CHIP CAP.	10pF	50V	CH	GRM1882C1H100JA01D	K22174211		1-6	A	D1
C 3050	CHIP CAP.	12pF	50V	CH	GRM1882C1H120JA01D	K22174213	VERSION A	7-	A	D1
C 3050	CHIP CAP.	10pF	50V	CH	GRM1882C1H100JA01D	K22174211	VERSION C	7-	A	D1
C 3051	CHIP CAP.	0.001uF	50V	B	GRM188B11H102KA01D	K22174821		1-	A	D2
C 3052	CHIP CAP.	0.001uF	50V	B	GRM188B11H102KA01D	K22174821		1-	A	B2
C 3053	CHIP CAP.	8pF	50V	CH	GRM1882C1H8R0DZ01D	K22174209		1-6	A	D1
C 3053	CHIP CAP.	10pF	50V	CH	GRM1882C1H100JA01D	K22174211	VERSION A	7-	A	D1
C 3053	CHIP CAP.	8pF	50V	CH	GRM1882C1H8R0DZ01D	K22174209	VERSION C	7-	A	D1
C 3054	CHIP CAP.	10pF	50V	CH	GRM1882C1H100JA01D	K22174211		1-6	A	D1
C 3054	CHIP CAP.	12pF	50V	CH	GRM1882C1H120JA01D	K22174213	VERSION A	7-	A	D1
C 3054	CHIP CAP.	10pF	50V	CH	GRM1882C1H100JA01D	K22174211	VERSION C	7-	A	D1
C 3055	CHIP CAP.	0.001uF	50V	B	GRM188B11H102KA01D	K22174821		1-	A	B2
C 3056	CHIP CAP.	0.001uF	50V	B	GRM188B11H102KA01D	K22174821		1-	A	B2
C 3057	CHIP CAP.	0.001uF	50V	B	GRM188B11H102KA01D	K22174821		1-	A	B2
C 3058	CHIP CAP.	0.1uF	16V	B	GRM188B11C104KA01D	K22124805		1-	B	c2
C 3059	CHIP CAP.	22pF	50V	CH	GRM1882C1H220JA01D	K22174219		1-6	A	D1
C 3059	CHIP CAP.	39pF	50V	CH	GRM1882C1H390JA01D	K22174225	VERSION A	7-	A	D1
C 3059	CHIP CAP.	22pF	50V	CH	GRM1882C1H220JA01D	K22174219	VERSION C	7-	A	D1
C 3060	CHIP CAP.	10pF	50V	CH	GRM1882C1H100JA01D	K22174211		1-6	A	D1
C 3060	CHIP CAP.	12pF	50V	CH	GRM1882C1H120JA01D	K22174213	VERSION A	7-	A	D1
C 3060	CHIP CAP.	10pF	50V	CH	GRM1882C1H100JA01D	K22174211	VERSION C	7-	A	D1
C 3061	CHIP CAP.	15pF	50V	CH	GRM1882C1H150JA01D	K22174215		1-	A	B2
C 3062	CHIP TA.CAP.	10uF	16V		TEMSVB21C106M-8R	K78120025		1-	B	e2
C 3063	CHIP CAP.	0.001uF	50V	B	GRM188B11H102KA01D	K22174821		1-	A	D2
C 3064	CHIP CAP.	18pF	50V	CH	GRM1882C1H180JA01D	K22174217		1-	A	B2
C 3065	CHIP CAP.	8pF	50V	CH	GRM1882C1H8R0CZ01D	K22174246		1-6	A	D1
C 3065	CHIP CAP.	10pF	50V	CH	GRM1882C1H100JA01D	K22174211	VERSION A	7-	A	D1
C 3065	CHIP CAP.	8pF	50V	CH	GRM1882C1H8R0CZ01D	K22174246	VERSION C	7-	A	D1
C 3066	CHIP TA.CAP.	10uF	16V		TEMSVB21C106M-8R	K78120025		1-	B	e2
C 3067	CHIP CAP.	9pF	50V	CH	GRM1882C1H9R0DZ01D	K22174210		1-6	A	D2
C 3067	CHIP CAP.	12pF	50V	CH	GRM1882C1H120JA01D	K22174213	VERSION A	7-	A	D2
C 3067	CHIP CAP.	9pF	50V	CH	GRM1882C1H9R0DZ01D	K22174210	VERSION C	7-	A	D2
C 3068	CHIP CAP.	100pF	50V	CH	GRM1882C1H101JA01D	K22174235		1-	B	e3
C 3069	CHIP CAP.	15pF	50V	CH	GRM1882C1H150JA01D	K22174215		1-6	A	C1
C 3069	CHIP CAP.	22pF	50V	CH	GRM1882C1H220JA01D	K22174219	VERSION A	7-	A	C1
C 3069	CHIP CAP.	15pF	50V	CH	GRM1882C1H150JA01D	K22174215	VERSION C	7-	A	C1
C 3070	CHIP CAP.	100pF	50V	CH	GRM1882C1H101JA01D	K22174235		1-	B	e3
C 3071	CHIP CAP.	27pF	50V	CH	GRM1882C1H270JA01D	K22174221		1-	A	C2
C 3072	CHIP CAP.	0.001uF	50V	B	GRM188B11H102KA01D	K22174821		1-	A	B1
C 3073	CHIP CAP.	12pF	50V	CH	GRM1882C1H120JA01D	K22174213		1-	A	C1
C 3074	CHIP CAP.	100pF	50V	CH	GRM1882C1H101JA01D	K22174235		1-	B	e3
C 3075	CHIP CAP.	100pF	50V	CH	GRM1882C1H101JA01D	K22174235		1-	A	B1
C 3076	CHIP CAP.	0.001uF	50V	B	GRM188B11H102KA01D	K22174821		1-	B	e3
C 3077	CHIP CAP.	47pF	50V	CH	GRM1882C1H470JA01D	K22174227		1-	A	C1
C 3078	CHIP CAP.	0.001uF	50V	B	GRM188B11H102KA01D	K22174821		1-	B	f3
C 3079	CHIP CAP.	0.001uF	50V	B	GRM188B11H102KA01D	K22174821		1-	A	B1
C 3080	CHIP CAP.	15pF	50V	CH	GRM1882C1H150JA01D	K22174215		1-	A	B1
C 3081	CHIP CAP.	5pF	50V	CH	GRM1882C1H5R0CZ01D	K22174206		1-	A	B1
C 3083	CHIP CAP.	0.01uF	50V	B	GRM188B11H103KA01D	K22174823		1-	B	c2
C 3084	CHIP CAP.	0.01uF	50V	B	GRM188B11H103KA01D	K22174823		1-	B	c2

REF.	DESCRIPTION	VALUE	V/W	TOL.	MFR'S DESIG	VXSTD P/N	VERS.	LOT.	SIDE	LAYADR
C 3086	CHIP CAP.	0.1uF	16V	B	GRM188B11C104KA01D	K22124805		1-	B	b3
C 3087	CHIP CAP.	22pF	50V	CH	GRM1882C1H220JA01D	K22174219		1-	A	E3
C 3088	CHIP CAP.	0.001uF	50V	B	GRM188B11H102KA01D	K22174821		1-	A	D3
C 3089	CHIP CAP.	56pF	50V	CH	GRM1882C1H560JA01D	K22174229		1-	A	E3
C 3091	CHIP CAP.	0.1uF	16V	B	GRM188B11C104KA01D	K22124805		1-	B	b3
C 3092	CHIP CAP.	0.1uF	16V	B	GRM188B11C104KA01D	K22124805		1-	B	a3
C 3094	CHIP CAP.	0.01uF	25V	B	GRM39B103M25PT	K22144802		1-	B	d3
C 3095	CHIP CAP.	0.001uF	50V	B	GRM188B11H102KA01D	K22174821		1-	B	b3
C 3096	CHIP CAP.	0.1uF	16V	B	GRM188B11C104KA01D	K22124805		1-	A	E3
C 3097	CHIP CAP.	0.001uF	50V	B	GRM188B11H102KA01D	K22174821		1-	B	d2
C 3098	CHIP CAP.	0.01uF	25V	B	GRM39B103M25PT	K22144802		1-	B	d2
C 3099	CHIP CAP.	82pF	50V	CH	GRM1882C1H820JA01D	K22174233		1-	A	D3
C 3100	CHIP CAP.	0.1uF	16V	B	GRM188B11C104KA01D	K22124805		1-	A	E3
C 3101	CHIP CAP.	0.01uF	25V	B	GRM39B103M25PT	K22144802		1-	A	C3
C 3102	CHIP CAP.	180pF	50V	CH	GRM1882C1H181JA01D	K22174241		1-	B	b2
C 3103	CHIP CAP.	180pF	50V	CH	GRM1882C1H181JA01D	K22174241		1-	B	b2
C 3104	CHIP CAP.	0.1uF	16V	B	GRM188B11C104KA01D	K22124805		1-	B	c3
C 3105	CHIP CAP.	0.001uF	50V	B	GRM188B11H102KA01D	K22174821		1-	B	a3
C 3106	CHIP CAP.	0.001uF	50V	B	GRM188B11H102KA01D	K22174821		1-	B	a2
C 3107	CHIP CAP.	0.001uF	50V	B	GRM188B11H102KA01D	K22174821		1-	B	e3
C 3108	CHIP CAP.	0.1uF	16V	B	GRM188B11C104KA01D	K22124805		1-	A	E2
C 3109	CHIP CAP.	0.01uF	25V	B	GRM39B103M25PT	K22144802		1-	B	c3
C 3110	CHIP TA.CAP.	10uF	10V		TEMSVA1A106M-8R	K78100028		1-	B	b3
C 3111	CHIP CAP.	0.001uF	50V	B	GRM188B11H102KA01D	K22174821		1-	B	b3
C 3112	CHIP CAP.	0.1uF	16V	B	GRM188B11C104KA01D	K22124805		1-	B	b3
C 3113	CHIP CAP.	0.001uF	50V	B	GRM188B11H102KA01D	K22174821		1-	B	e3
C 3114	CHIP CAP.	0.001uF	50V	B	GRM188B11H102KA01D	K22174821		1-	B	b2
C 3115	CHIP CAP.	0.0047uF	50V	B	GRM188B11H472KA01D	K22174817		1-	B	c2
C 3116	CHIP CAP.	0.001uF	50V	B	GRM188B11H102KA01D	K22174821		1-	B	d3
C 3117	CHIP CAP.	12pF	50V	CH	GRM1882C1H120JA01D	K22174213		1-	B	c3
C 3118	CHIP CAP.	0.001uF	50V	B	GRM188B11H102KA01D	K22174821		1-	B	e3
C 3119	CHIP CAP.	0.1uF	16V	B	GRM188B11C104KA01D	K22124805		1-	A	E2
C 3120	CHIP CAP.	0.001uF	50V	B	GRM188B11H102KA01D	K22174821		1-	B	e3
C 3121	CHIP CAP.	39pF	50V	CH	GRM1882C1H390JA01D	K22174225		1-	A	D3
C 3122	CHIP CAP.	0.001uF	50V	B	GRM188B11H102KA01D	K22174821		1-	B	e3
C 3123	CHIP CAP.	0.001uF	50V	B	GRM188B11H102KA01D	K22174821		1-	A	D3
C 3125	CHIP CAP.	0.001uF	50V	B	GRM188B11H102KA01D	K22174821		1-	A	D3
C 3126	CHIP CAP.	0.01uF	25V	B	GRM39B103M25PT	K22144802		1-	A	D3
C 3127	CHIP TA.CAP.	10uF	10V		TEMSVA1A106M-8R	K78100028		1-	A	C3
C 3128	CHIP CAP.	0.1uF	16V	B	GRM188B11C104KA01D	K22124805		1-	A	E2
C 3129	CHIP CAP.	0.1uF	16V	B	GRM188B11C104KA01D	K22124805		1-	A	E2
C 3130	CHIP CAP.	0.001uF	50V	B	GRM188B11H102KA01D	K22174821		1-	A	C3
C 3131	CHIP CAP.	0.047uF	16V	B	GRM39B473K16PT	K22124804		1-	A	E2
C 3132	CHIP CAP.	0.001uF	50V	B	GRM188B11H102KA01D	K22174821		1-	A	C3
C 3133	CHIP TA.CAP.	10uF	16V		TEMSVB21C106M-8R	K78120025		1-	B	d3
C 3134	CHIP CAP.	0.001uF	50V	B	GRM188B11H102KA01D	K22174821		1-	A	B1
C 3136	CHIP CAP.	1pF	50V	CK	GRM1884C1H1ROCZ01D	K22174202		1-	A	A2
C 3137	CHIP CAP.	18pF	50V	UJ	GRM1883U1H180JZ01D	K22174314		1-	A	A2
C 3138	TANTALUM CAP.	10uF	10V		TPDN1A100M8S(MX0)	K76100006		1-	B	c3
C 3138	CHIP TA.CAP.	10uF	10V		TEMSVA1A106M-8R	K78100028		3-	B	c3
CD3001	CERAMIC DISC				CDBLA455KCAY07-B0	H7900180		1-	A	D2
CF3001	CERAMIC FILTER				CFWLB455KGF A-B0	H3900399		1-	A	E3
CF3002	CERAMIC FILTER				CFWLB455KFFA-B0	H3900395		1-	A	F3
D 3001	DIODE				MA143-(TX)	G2070536		1-	B	a1
D 3002	DIODE				RD6.8UMB2-T1B	G2070438		1-	B	f2
D 3003	DIODE				RN739F T106	G2070626		1-	A	F1
D 3004	DIODE				HVU350TRF	G2070380		1-	A	E1
D 3005	DIODE				HVU350TRF	G2070380		1-	A	B3
D 3006	DIODE				HVU350TRF	G2070380		1-	A	B3
D 3007	DIODE				HVU350TRF	G2070380		1-	A	A2
D 3008	DIODE				HVU350TRF	G2070380		1-	A	E1
D 3009	DIODE				HVU350TRF	G2070380		1-	A	B3

RX Unit

REF.	DESCRIPTION	VALUE	V/W	TOL.	MFR'S DESIG	VXSTD P/N	VERS.	LOT.	SIDE	LAYADR
D 3010	DIODE				HVU350TRF	G2070380		1-	A	B3
D 3011	DIODE				MA143-(TX)	G2070536		1-	A	E1
D 3012	DIODE				HVU350TRF	G2070380		1-	A	D1
D 3013	DIODE				HVU350TRF	G2070380		1-	A	D1
D 3014	IC				GN2011-Q(TX)	G1092183		1-	A	C2
D 3014	IC				GN2011-P(TX)	G1094261		91-	A	C2
D 3015	DIODE				MA142WK-(TX)	G2070534		1-	B	b3
D 3016	DIODE				MA142WK-(TX)	G2070534		1-	B	b3
D 3017	DIODE				RD5.6EB3	G2090193		1-	B	c2
D 3017	DIODE				HZM5.6NB2 TR	G2070722		6-	B	c2
D 3018	DIODE				MA143-(TX)	G2070536		1-	A	E2
D 3019	DIODE				MA143-(TX)	G2070536		1-	A	E2
D 3021	DIODE				MA143-(TX)	G2070536		1-	B	f2
J 3001	CONNECTOR				TMP-J01X-V6	P1090210		1-	A	C1
JP3001	WIRE ASSY				A1367+	T9206791		1-	A	A3
JP3002	WIRE ASSY				A1367+	T9206788		1-		
JP3051	WIRE ASSY				GRN 55 2/2	T50505500		3-		
JP3052	WIRE ASSY				GRN 35 2/2	T50503500		11-		
L 3001	M.RFC	10uH			LK1608 100K-T	L1690689		1-	A	F2
L 3002	CHIP COIL	0.1uH			C2520C-R10J	L1690544		1-6	A	E1
L 3002	CHIP COIL	0.12uH			C2520C-R12J	L1690545	VERSION A	7-	A	E1
L 3002	CHIP COIL	0.1uH			C2520C-R10J	L1690544	VERSION C	7-	A	E1
L 3003	CHIP COIL	0.68uH			C2520C-R68J	L1690554		1-	A	B3
L 3004	CHIP COIL	0.1uH			C2520C-R10J	L1690544		1-6	A	E1
L 3004	CHIP COIL	0.12uH			C2520C-R12J	L1690545	VERSION A	7-	A	E1
L 3004	CHIP COIL	0.1uH			C2520C-R10J	L1690544	VERSION C	7-	A	E1
L 3005	COIL				E2 0.3-1.7-8T-L	L0022376		1-6	A	C3
L 3005	COIL				E2 0.25-1.9-8T-L	L0022550	VERSION A	7-	A	C3
L 3005	COIL				E2 0.3-1.7-8T-L	L0022376	VERSION C	7-	A	C3
L 3006	CHIP COIL	0.22uH			C2520C-R22J	L1690548		1-	A	B2
L 3007	CHIP COIL	0.82uH			C2520C-R82J	L1690555		1-	A	D1
L 3008	M.RFC	0.22uH			LK2125 R22K-T	L1690311		1-	A	C2
L 3009	CHIP COIL	0.1uH			C2520C-R10J	L1690544		1-6	A	D1
L 3009	CHIP COIL	0.12uH			C2520C-R12J	L1690545	VERSION A	7-	A	D1
L 3009	CHIP COIL	0.1uH			C2520C-R10J	L1690544	VERSION C	7-	A	D1
L 3010	CHIP COIL	0.22uH			C2520C-R22J	L1690548		1-	A	B2
L 3011	CHIP COIL	0.047uH			C2520C-47NK	L1690540		1-	A	B2
L 3012	CHIP COIL	0.1uH			C2520C-R10J	L1690544		1-6	A	D1
L 3012	CHIP COIL	0.12uH			C2520C-R12J	L1690545	VERSION A	7-	A	D1
L 3012	CHIP COIL	0.1uH			C2520C-R10J	L1690544	VERSION C	7-	A	D1
L 3013	M.RFC	0.082uH			LK2125 82NM-T	L1690604		1-	A	C1
L 3015	M.RFC	0.082uH			LK2125 82NM-T	L1690604		1-	A	C1
L 3016	CHIP COIL	0.22uH			C2520C-R22J	L1690548		1-	A	B1
L 3017	M.RFC	10uH			LK2125 100K-T	L1690331		1-	B	d2
L 3018	CHIP COIL	1uH			C2520F-1R0K	L1690584		1-	A	D3
L 3019	M.RFC	0.047uH			HK1608 47NJ-T	L1690524		1-	A	D2
Q 3001	IC				MB15A02PFV1-G-BND-EFE1	G1092541		1-	A	A2
Q 3002	TRANSISTOR				2SC4116GR TE85R	G3341167G		1-	A	A2
Q 3003	TRANSISTOR				2SA1586Y TE85R	G3115867Y		1-	A	A1
Q 3004	TRANSISTOR				UN5215-(TX)	G3070193		1-	A	A1
Q 3005	TRANSISTOR				2SC4116GR TE85R	G3341167G		1-	B	f2
Q 3006	TRANSISTOR				2SA1586Y TE85R	G3115867Y		1-	B	f2
Q 3007	FET				2SK508-T2B K52	G3805087B		1-	A	C2
Q 3008	TRANSISTOR				2SC3357-T2 RF	G3333577F		1-	A	D1
Q 3009	TRANSISTOR				2SC5226-4/5-TL	G3352268Z		1-	A	B2
Q 3010	TRANSISTOR				2SC4116GR TE85R	G3341167G		1-	B	e2
Q 3011	TRANSISTOR				2SC3357-T2 RF	G3333577F		1-	A	B1
Q 3012	IC				TA31136FN(EL)	G1091605		1-	A	E3
Q 3013	TRANSISTOR				2SC2812L6-TA	G3328127F		1-	B	c3
Q 3013	TRANSISTOR				2SC2812NL6-TB	G3328128F		18-	B	c3
Q 3014	TRANSISTOR				2SC4116GR TE85R	G3341167G		1-	A	E2
Q 3015	TRANSISTOR				XN1213-(TX)	G3070194		1-	B	a3

REF.	DESCRIPTION	VALUE	V/W	TOL.	MFR'S DESIG	VXSTD P/N	VERS.	LOT.	SIDE	LAYADR
Q 3016	TRANSISTOR				2SC2620QBTR	G3326207B		1-	A	D3
Q 3018	TRANSISTOR				2SB1122S-TD	G3211228S		1-	B	c2
Q 3020	TRANSISTOR				XN1213-(TX)	G3070194		1-	B	b3
Q 3021	IC				TA78L05F TE12R	G1091014		1-	A	C3
Q 3022	TRANSISTOR				XN1213-(TX)	G3070194		1-	B	b2
R 3001	CHIP RES.	10k	1/16W	5%	RMC1/16 103JATP	J24185103		1-	B	a1
R 3002	CHIP RES.	10k	1/16W	5%	RMC1/16 103JATP	J24185103		1-	B	f1
R 3003	CHIP RES.	100	1/16W	5%	RMC1/16 101JATP	J24185101		1-	B	a2
R 3004	CHIP RES.	560	1/16W	5%	RMC1/16 561JATP	J24185561		1-	B	e1
R 3005	CHIP RES.	1.8k	1/16W	5%	RMC1/16 182JATP	J24185182		1-	B	e2
R 3006	CHIP RES.	1k	1/16W	5%	RMC1/16 102JATP	J24185102		1-	A	A2
R 3007	CHIP RES.	1.8k	1/16W	5%	RMC1/16 182JATP	J24185182		1-	B	e2
R 3008	CHIP RES.	6.8k	1/16W	5%	RMC1/16 682JATP	J24185682		1-	B	e2
R 3009	CHIP RES.	47	1/16W	5%	RMC1/16 470JATP	J24185470		1-	A	A2
R 3010	CHIP RES.	47k	1/16W	5%	RMC1/16 473JATP	J24185473		1-	A	E2
R 3011	CHIP RES.	33k	1/16W	5%	RMC1/16 333JATP	J24185333		1-	A	A1
R 3012	CHIP RES.	22k	1/16W	5%	RMC1/16 223JATP	J24185223		1-	A	A2
R 3013	CHIP RES.	47k	1/16W	5%	RMC1/16 473JATP	J24185473		1-	A	A2
R 3014	CHIP RES.	33	1/16W	5%	RMC1/16 330JATP	J24185330		1-	A	B3
R 3015	CHIP RES.	1k	1/16W	5%	RMC1/16 102JATP	J24185102		1-	A	A2
R 3016	CHIP RES.	100k	1/16W	5%	RMC1/16 104JATP	J24185104		1-	A	A1
R 3017	CHIP RES.	47k	1/16W	5%	RMC1/16 473JATP	J24185473		1-	A	E2
R 3018	CHIP RES.	10k	1/16W	5%	RMC1/16 103JATP	J24185103		1-	A	A1
R 3019	CHIP RES.	47k	1/16W	5%	RMC1/16 473JATP	J24185473		1-	A	A2
R 3020	CHIP RES.	4.7k	1/16W	5%	RMC1/16 472JATP	J24185472		1-	A	A1
R 3023	CHIP RES.	100	1/16W	5%	RMC1/16 101JATP	J24185101		1-	A	B2
R 3024	CHIP RES.	3.3k	1/16W	5%	RMC1/16 332JATP	J24185332		1-	A	D2
R 3025	CHIP RES.	2.2k	1/16W	5%	RMC1/16 222JATP	J24185222		1-	A	E1
R 3026	CHIP RES.	1k	1/16W	5%	RMC1/16 102JATP	J24185102		1-	A	D1
R 3027	CHIP RES.	220	1/16W	5%	RMC1/16 221JATP	J24185221		1-	A	D1
R 3028	CHIP RES.	10	1/16W	5%	RMC1/16 100JATP	J24185100		1-	A	D2
R 3028	CHIP RES.	100	1/16W	5%	RMC1/16 101JATP	J24185101		11-	A	D2
R 3029	CHIP RES.	47k	1/16W	1%	RMC1/16 473FTP	J24183473		1-	A	A3
R 3030	CHIP RES.	12k	1/16W	1%	RMC1/16 123FTP	J24183123		1-	A	A2
R 3031	CHIP RES.	1k	1/16W	5%	RMC1/16 102JATP	J24185102		1-	A	C2
R 3032	CHIP RES.	3.3k	1/16W	5%	RMC1/16 332JATP	J24185332		1-	A	B2
R 3033	CHIP RES.	2.2k	1/16W	5%	RMC1/16 222JATP	J24185222		1-	A	B2
R 3034	CHIP RES.	47k	1/16W	5%	RMC1/16 473JATP	J24185473		1-	A	D2
R 3035	CHIP RES.	220	1/16W	5%	RMC1/16 221JATP	J24185221		1-	A	B2
R 3036	CHIP RES.	100	1/16W	5%	RMC1/16 101JATP	J24185101		1-	A	B2
R 3037	CHIP RES.	47k	1/16W	5%	RMC1/16 473JATP	J24185473		1-	A	D2
R 3038	CHIP RES.	18	1/16W	5%	RMC1/16 180JATP	J24185180		1-	A	B2
R 3039	CHIP RES.	18	1/16W	5%	RMC1/16 180JATP	J24185180		1-	B	e1
R 3040	CHIP RES.	2.2k	1/16W	5%	RMC1/16 222JATP	J24185222		1-	B	e2
R 3042	CHIP RES.	18	1/16W	5%	RMC1/16 180JATP	J24185180		1-	B	e1
R 3043	CHIP RES.	56	1/16W	5%	RMC1/16 560JATP	J24185560		1-	B	d2
R 3044	CHIP RES.	10k	1/16W	5%	RMC1/16 103JATP	J24185103		1-	A	B1
R 3045	CHIP RES.	4.7k	1/16W	5%	RMC1/16 472JATP	J24185472		1-	A	B1
R 3046	CHIP RES.	150	1/16W	5%	RMC1/16 151JATP	J24185151		1-	A	B1
R 3046	CHIP RES.	100	1/16W	5%	RMC1/16 101JATP	J24185101		11-	A	B1
R 3047	CHIP RES.	100	1/10W	5%	RMC1/10T 101J	J24205101		1-	A	B1
R 3048	CHIP RES.	470	1/16W	5%	RMC1/16 471JATP	J24185471		1-	A	B1
R 3049	CHIP RES.	100	1/16W	5%	RMC1/16 101JATP	J24185101		1-	B	c2
R 3049	CHIP RES.	100	1/16W	1%	RMC1/16 101FTP	J24183101		6-	B	c2
R 3050	CHIP RES.	100	1/16W	5%	RMC1/16 101JATP	J24185101		1-	B	c2
R 3050	CHIP RES.	100	1/16W	1%	RMC1/16 101FTP	J24183101		6-	B	c2
R 3051	CHIP RES.	22k	1/16W	5%	RMC1/16 223JATP	J24185223		1-	B	b3
R 3052	CHIP RES.	47k	1/16W	5%	RMC1/16 473JATP	J24185473		1-	A	E3
R 3054	CHIP RES.	33k	1/16W	5%	RMC1/16 333JATP	J24185333		1-	B	a3
R 3055	CHIP RES.	33k	1/16W	5%	RMC1/16 333JATP	J24185333		1-	B	a3
R 3056	CHIP RES.	1.2k	1/16W	5%	RMC1/16 122JATP	J24185122		1-	A	D3
R 3057	CHIP RES.	33k	1/16W	5%	RMC1/16 333JATP	J24185333		1-	B	b3

RX Unit

REF.	DESCRIPTION	VALUE	V/W	TOL.	MFR'S DESIG	VXSTD P/N	VERS.	LOT.	SIDE	LAYADR
R 3058	CHIP RES.	33k	1/16W	5%	RMC1/16 333JATP	J24185333		1-	B	b3
R 3059	CHIP RES.	150k	1/16W	5%	RMC1/16 154JATP	J24185154		1-	B	b3
R 3061	CHIP RES.	0	1/16W	5%	RMC1/16 000JATP	J24185000		1-	A	C3
R 3063	CHIP RES.	10k	1/16W	5%	RMC1/16 103JATP	J24185103		1-	B	a2
R 3064	CHIP RES.	1k	1/16W	5%	RMC1/16 102JATP	J24185102		1-	B	d3
R 3065	CHIP RES.	1.8k	1/16W	5%	RMC1/16 182JATP	J24185182		1-	B	b2
R 3066	CHIP RES.	22k	1/16W	5%	RMC1/16 223JATP	J24185223		1-	B	b3
R 3067	CHIP RES.	6.8k	1/16W	5%	RMC1/16 682JATP	J24185682		1-	B	b3
R 3068	CHIP RES.	1.8k	1/16W	5%	RMC1/16 182JATP	J24185182		1-	B	b2
R 3069	CHIP RES.	330	1/10W	5%	RMC1/10T 331J	J24205331		1-	B	c3
R 3070	CHIP RES.	10k	1/16W	5%	RMC1/16 103JATP	J24185103		1-	B	a2
R 3071	CHIP RES.	47	1/16W	5%	RMC1/16 470JATP	J24185470		1-	A	E2
R 3072	CHIP RES.	220k	1/16W	5%	RMC1/16 224JATP	J24185224		1-	A	E2
R 3074	CHIP RES.	1k	1/16W	5%	RMC1/16 102JATP	J24185102		1-	A	D3
R 3075	CHIP RES.	1k	1/16W	5%	RMC1/16 102JATP	J24185102		1-	A	E2
R 3076	CHIP RES.	100	1/16W	5%	RMC1/16 101JATP	J24185101		1-	A	E2
R 3077	CHIP RES.	47k	1/16W	5%	RMC1/16 473JATP	J24185473		1-	A	D3
R 3078	CHIP RES.	47k	1/16W	5%	RMC1/16 473JATP	J24185473		1-	A	D3
R 3080	CHIP RES.	6.8k	1/16W	5%	RMC1/16 682JATP	J24185682		1-	B	b3
R 3082	CHIP RES.	220	1/16W	5%	RMC1/16 221JATP	J24185221		1-	A	D3
R 3083	CHIP RES.	12k	1/16W	5%	RMC1/16 123JATP	J24185123		1-	A	E2
R 3084	CHIP RES.	18k	1/16W	5%	RMC1/16 183JATP	J24185183		1-	A	E2
R 3086	CHIP RES.	1k	1/16W	5%	RMC1/16 102JATP	J24185102		1-	A	D2
R 3088	CHIP RES.	10k	1/16W	5%	RMC1/16 103JATP	J24185103		1-	B	b2
R 3089	CHIP RES.	10k	1/16W	5%	RMC1/16 103JATP	J24185103		1-	B	b2
R 3090	CHIP RES.	33k	1/16W	5%	RMC1/16 333JATP	J24185333		1-	A	E2
R 3092	CHIP RES.	10k	1/16W	5%	RMC1/16 103JATP	J24185103		1-	B	c3
R 3093	CHIP RES.	10k	1/16W	5%	RMC1/16 103JATP	J24185103		1-	B	b2
R 3096	CHIP RES.	4.7k	1/16W	5%	RMC1/16 472JATP	J24185472		1-	B	c3
R 3099	CHIP RES.	18k	1/16W	1%	RMC1/16 183FTP	J24183183		1-	A	A2
R 3100	CHIP RES.	100k	1/16W	1%	RMC1/16 104FTP	J24183104		1-	A	A3
R 3101	CHIP RES.	8.2k	1/16W	1%	RMC1/16 822FTP	J24183822		1-	A	A3
R 3102	CHIP RES.	47k	1/16W	1%	RMC1/16 473FTP	J24183473		1-	A	A3
R 3103	CHIP RES.	3.9k	1/16W	1%	RMC1/16 392FTP	J24183392		1-	A	A2
R 3106	CHIP RES.	4.7k	1/16W	5%	RMC1/16 472JATP	J24185472		1-	B	a2
R 3107	CHIP RES.	56k	1/16W	1%	RMC1/16 563FTP	J24183563		1-	A	A3
R 3108	CHIP RES.	6.8k	1/16W	1%	RMC1/16 682FTP	J24183682		1-	B	f2
R 3109	CHIP RES.	4.7k	1/16W	1%	RMC1/16 472FTP	J24183472		1-	B	f2
R 3110	CHIP RES.	2.7k	1/16W	1%	RMC1/16 272FTP	J24183272		1-	B	f2
R 3111	CHIP RES.	1k	1/16W	1%	RMC1/16 102FTP	J24183102		1-	A	A2
R 3112	CHIP RES.	1.8k	1/16W	1%	RMC1/16 182FTP	J24183182		1-	A	A3
R 3113	CHIP RES.	0	1/16W	5%	RMC1/16 000JATP	J24185000		1-	B	f2
R 3114	CHIP RES.	0	1/16W	5%	RMC1/16 000JATP	J24185000		1-	B	f2
T 3001	COIL WIDE-TRANS.				3-317611	L0022478		1-	A	C2
T 3002	COIL WIDE-TRANS.				3-317610	L0022479		1-	A	C2
T 3003	COIL WIDE-TRANS.				3-317611	L0022478		1-	A	C2
TC3001	TRIMMER CAP.	10pF			ECR-JA010A11X	K91000227		1-	A	A2
TH3001	THERMISTOR				NTCCM20123SH223JCT	G9090106		1-	A	A3
TH3002	THERMISTOR				NTCCM20123NH153JCT	G9090105		1-	A	A3
X 3001	XTAL TOP-B	14.4MHz			14.4MHZ	H0103221		1-	A	A2
X 3002	XTAL LP-5.0S.2S	20.945MHz			20.945MHZ	H0103169		1-	A	D3
XF3001	XTAL FILTER				21M10B1	H1102314		1-	A	C3
XF3002	XTAL FILTER				21M10B1	H1102314		1-	A	C3
	SHIELD CASE				VCO	RA0014300		1-		
	SHIELD CASE					R0151950		1-		
	SHIELD CASE					RA0014200		1-		
	NYLON CLAMP				PLT-1M BK-1	S3000022		1-		

Circuit Diagram

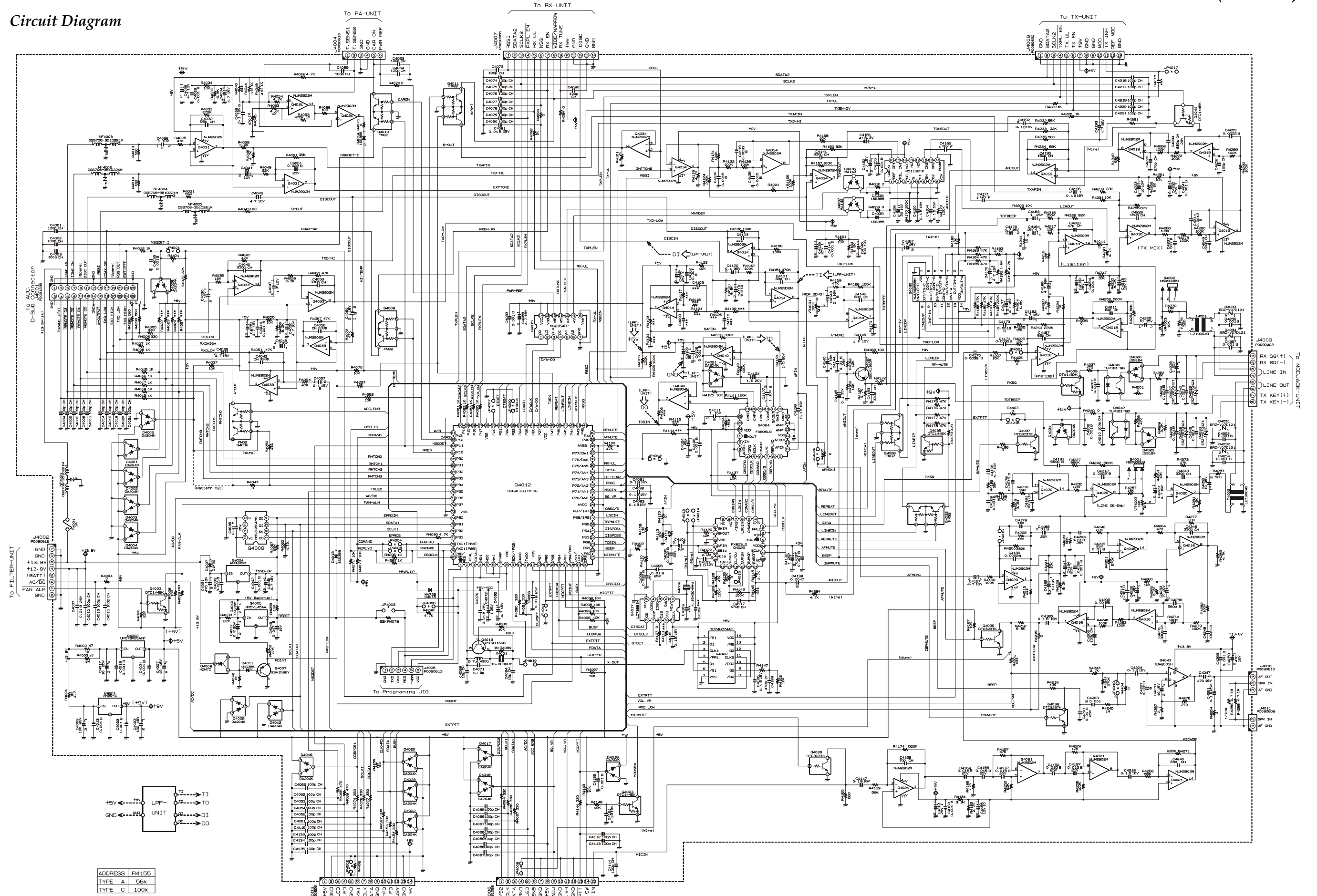

CNTL Unit (Lot. 1~)

Parts Layout

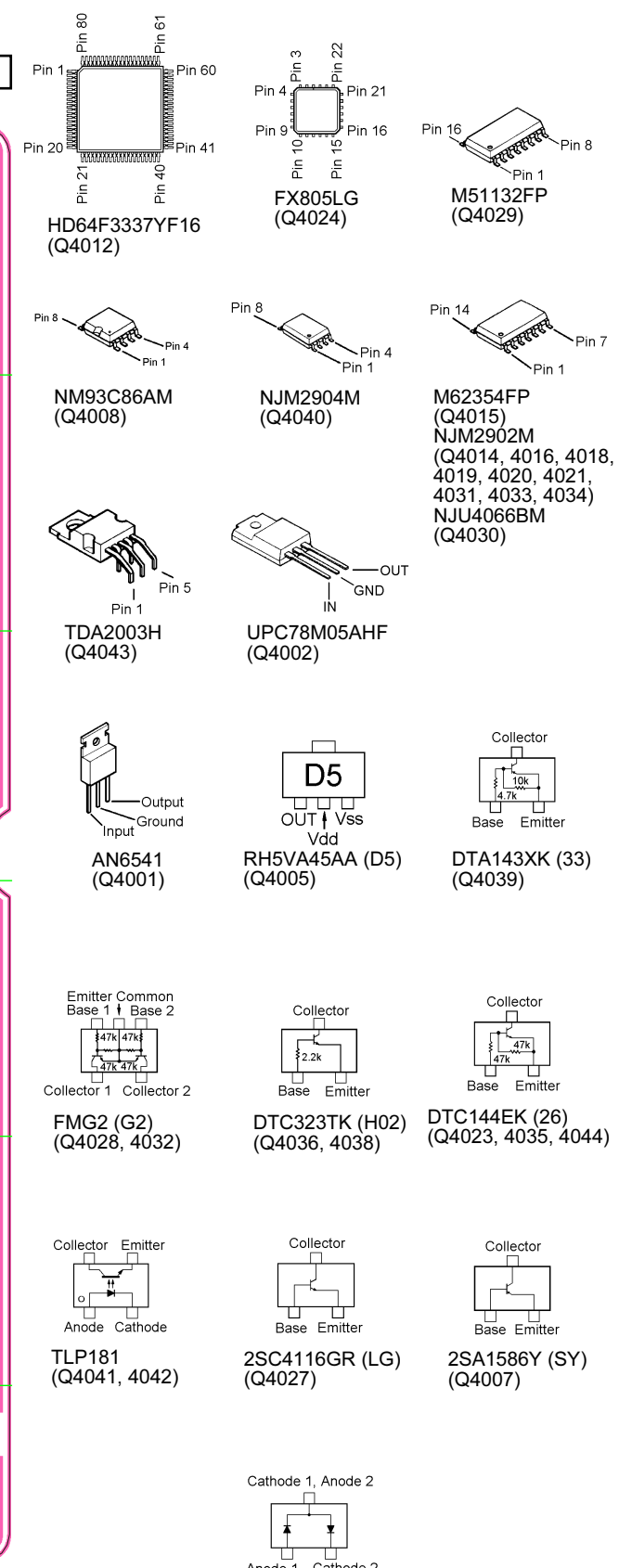
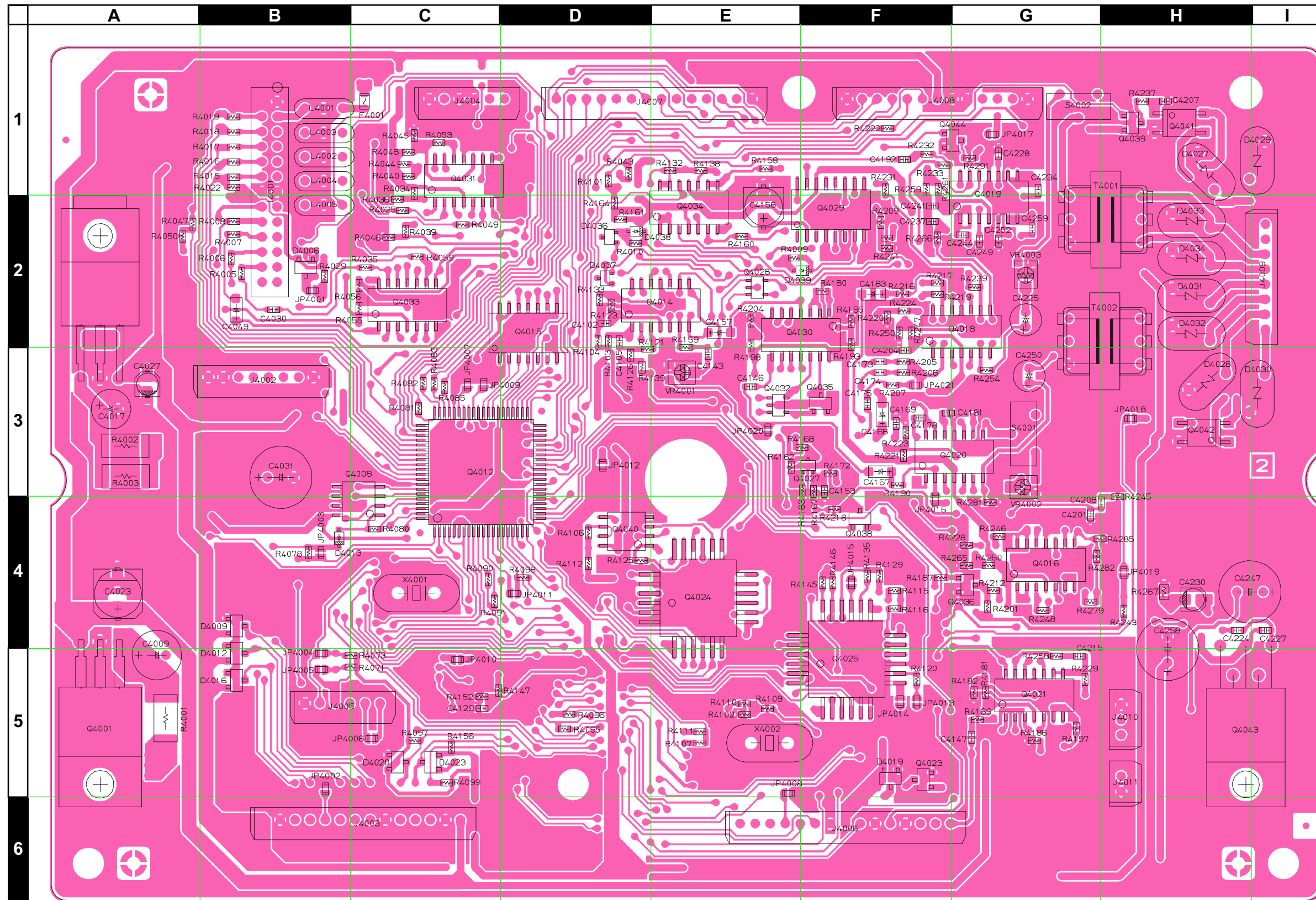

Side A

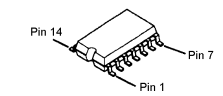
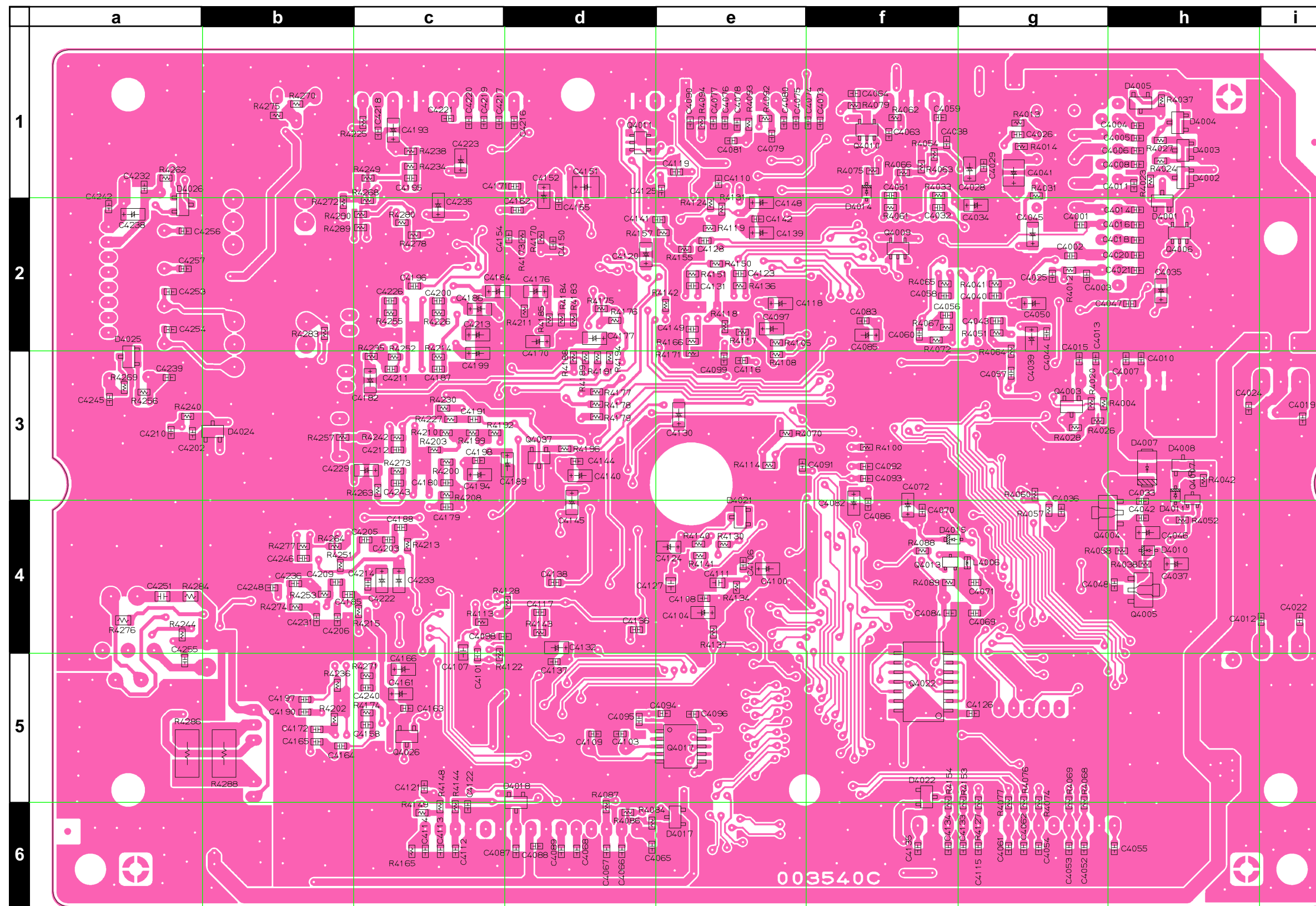

TCT74HC74AF (Q4022)

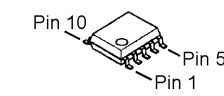

LC73881M (Q4017)

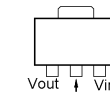

AN8005M (Q4004)

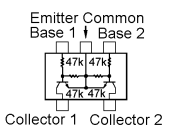

FMG2 (G2) (Q4006, 4009, 4010, 4011)

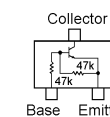

DTC144EK (26) (Q4003)

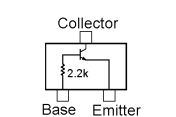

DTC323TK (H02) (Q4026, 4037)

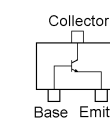

2SC4116GR (LG) (Q4013)

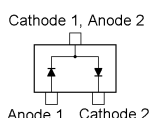

DA204K (K) (D4001, 4002, 4003, 4004, 4005, 4017, 4018, 4021, 4024)

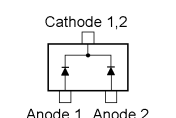

1SS184 (B3) (D4025, 4026)

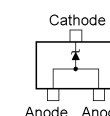

HZM7C (24) (D4008)

Side B

CNTL Unit (Lot. 6~)

Circuit Diagram

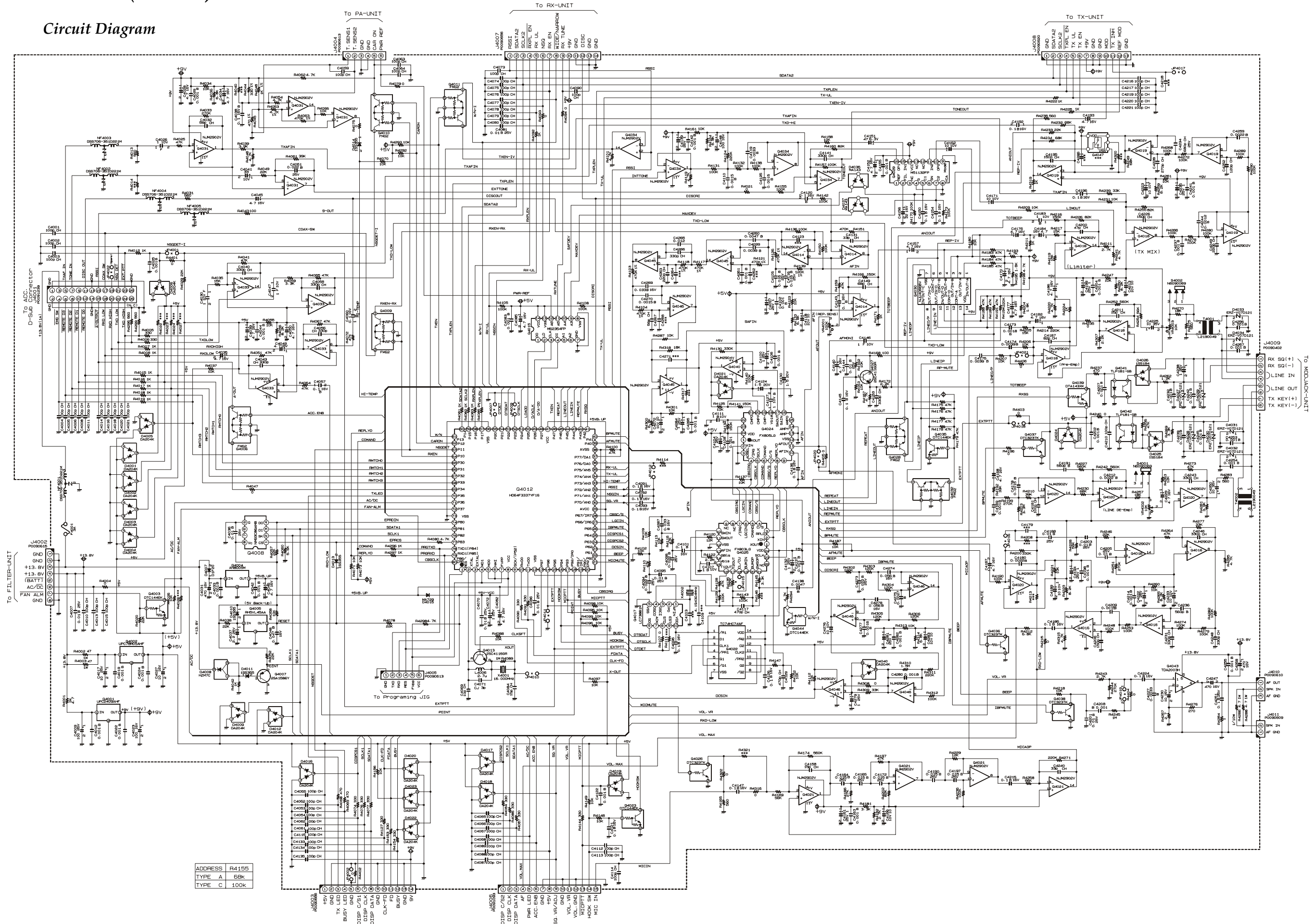

ADDRESS	R4155
TYPE A	68k
TYPE C	100k

Parts Layout

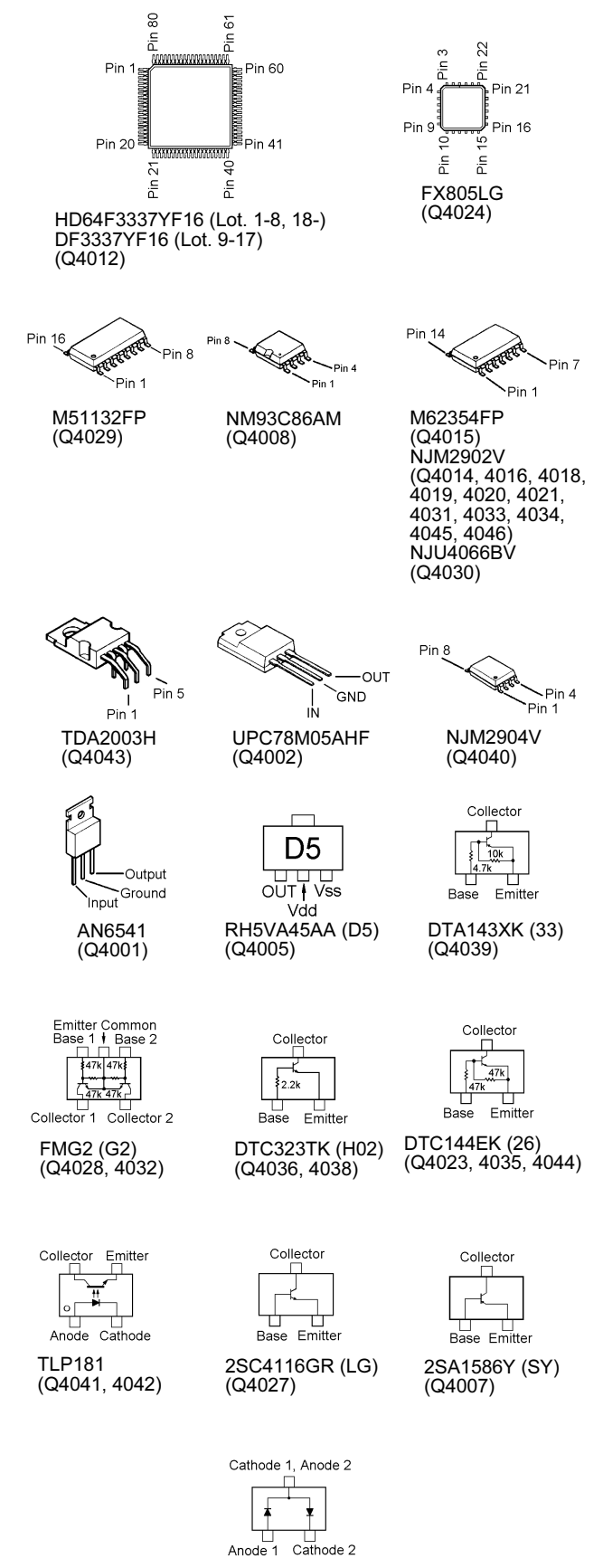
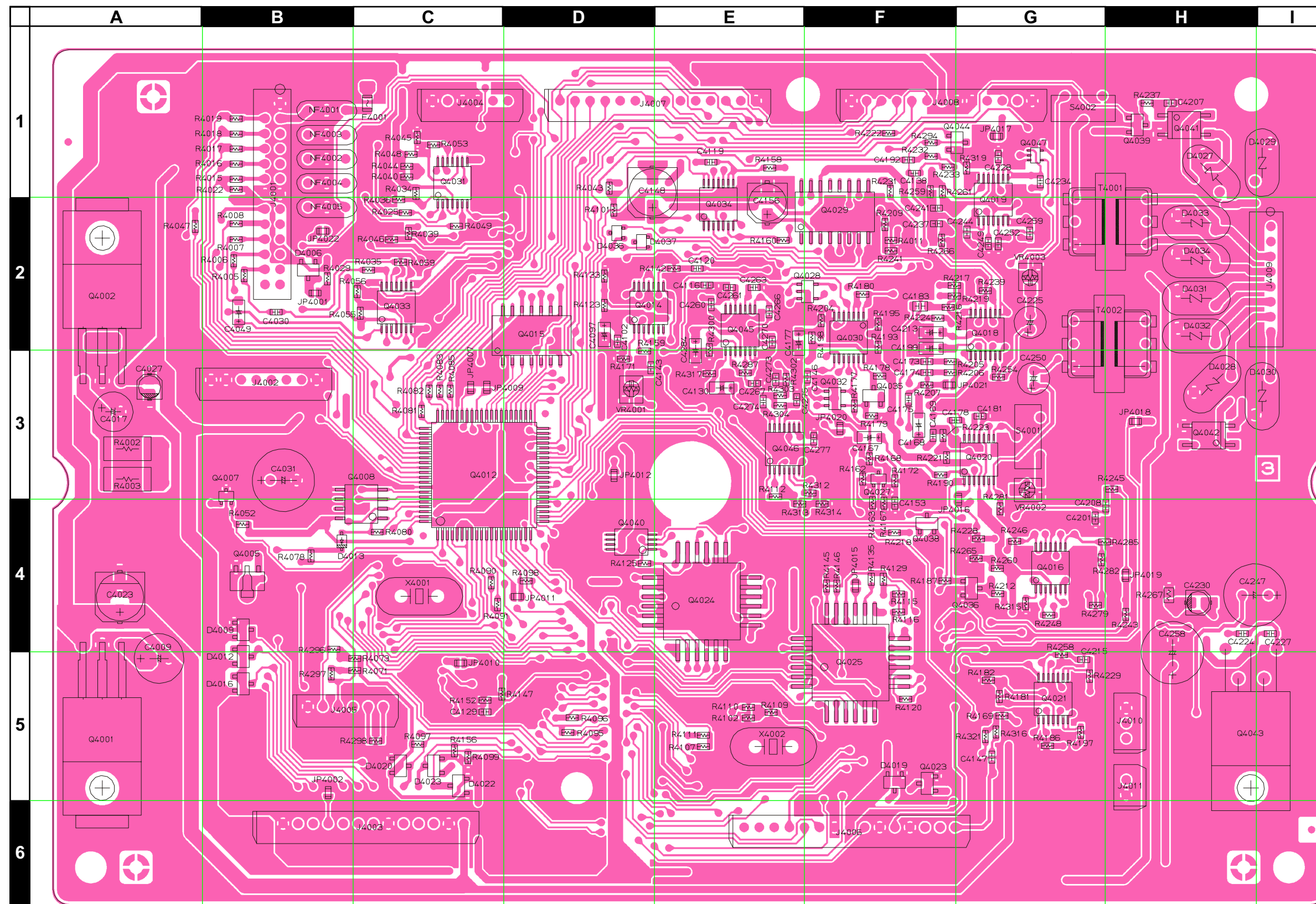

Side A

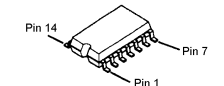
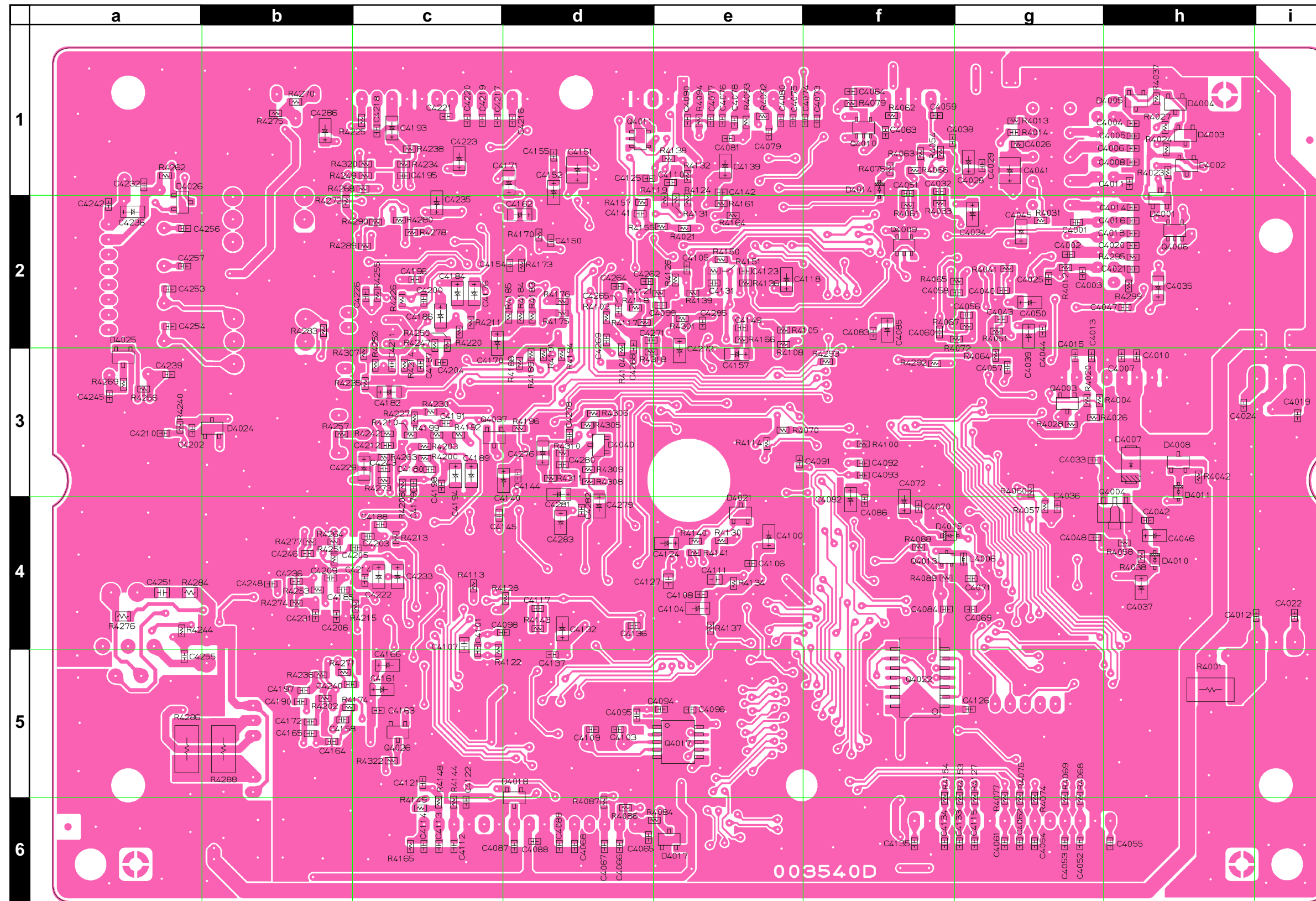

TC74HC74AF (Q4022)

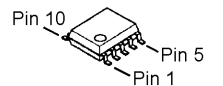

LC73881M (Q4017)

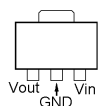

AN8005M (Q4004)

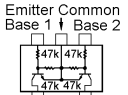

FMG2 (G2) (Q4006, 4009, 4010, 4011)

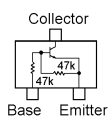

DTC144EK (26) (Q4003)

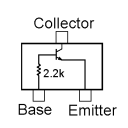

DTC323TK (H02) (Q4026, 4037)

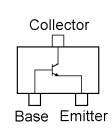

2SC4116GR (LG) (Q4013)

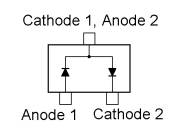

DA204K (K) (D4001, 4002, 4003, 4004, 4005, 4017, 4018, 4021, 4024, 4040)

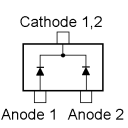

1SS184 (B3) (D4025, 4026)

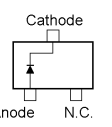

HZM7.5NB2 (D4008)

Side B

Parts List

REF.	DESCRIPTION	VALUE	V/W	TOL.	MFR'S DESIG	VXSTD P/N	VERS.	LOT.	SIDE	LAYADR
*** CNTL UNIT ***										
PCB with Components						CS1647001	VERSION C			
PCB with Components						CS1647002	VERSION A			
	Printed Circuit Board					FR003540C		1-		
	Printed Circuit Board					FR003540D		6-		
C 4001	CHIP CAP.	100pF	50V	CH	GRM1882C1H101JA01D	K22174235		1-	B	g2
C 4002	CHIP CAP.	100pF	50V	CH	GRM1882C1H101JA01D	K22174235		1-	B	g2
C 4003	CHIP CAP.	100pF	50V	CH	GRM1882C1H101JA01D	K22174235		1-	B	g2
C 4004	CHIP CAP.	100pF	50V	CH	GRM1882C1H101JA01D	K22174235		1-	B	h1
C 4005	CHIP CAP.	100pF	50V	CH	GRM1882C1H101JA01D	K22174235		1-	B	h1
C 4006	CHIP CAP.	100pF	50V	CH	GRM1882C1H101JA01D	K22174235		1-	B	h1
C 4007	CHIP CAP.	0.01uF	25V	B	GRM39B103K25PT	K22144803		1-	B	h3
C 4008	CHIP CAP.	100pF	50V	CH	GRM1882C1H101JA01D	K22174235		1-	B	h1
C 4009	AL.ELECTRO.CAP.	100uF	25V		RE2-25V101MH3#	K40149028		1-	A	A5
C 4010	CHIP CAP.	100pF	50V	CH	GRM1882C1H101JA01D	K22174235		1-	B	h3
C 4011	CHIP CAP.	100pF	50V	CH	GRM1882C1H101JA01D	K22174235		1-	B	h1
C 4012	CHIP CAP.	0.001uF	50V	B	GRM188B11H102KA01D	K22174821		1-	B	h4
C 4013	CHIP CAP.	100pF	50V	CH	GRM1882C1H101JA01D	K22174235		1-	B	g3
C 4014	CHIP CAP.	100pF	50V	CH	GRM1882C1H101JA01D	K22174235		1-	B	h2
C 4015	CHIP CAP.	100pF	50V	CH	GRM1882C1H101JA01D	K22174235		1-	B	g3
C 4016	CHIP CAP.	100pF	50V	CH	GRM1882C1H101JA01D	K22174235		1-	B	h2
C 4017	AL.ELECTRO.CAP.	10uF	25V		RC2-25V100ME1#	K40149012		1-	A	A3
C 4018	CHIP CAP.	100pF	50V	CH	GRM1882C1H101JA01D	K22174235		1-	B	h2
C 4019	CHIP CAP.	0.001uF	50V	B	GRM188B11H102KA01D	K22174821		1-	B	i3
C 4020	CHIP CAP.	100pF	50V	CH	GRM1882C1H101JA01D	K22174235		1-	B	h2
C 4021	CHIP CAP.	100pF	50V	CH	GRM1882C1H101JA01D	K22174235		1-	B	h2
C 4022	CHIP CAP.	0.001uF	50V	B	GRM188B11H102KA01D	K22174821		1-	B	i4
C 4023	AL.ELECTRO.CAP.	100uF	16V		ECEV1CA101WP	K48120012		1-	A	A4
C 4024	CHIP CAP.	0.001uF	50V	B	GRM188B11H102KA01D	K22174821		1-	B	h3
C 4025	CHIP CAP.	0.001uF	50V	B	GRM188B11H102KA01D	K22174821		1-	B	g2
C 4026	CHIP CAP.	1uF	10V	F	GRM188F11A105ZA01D	K22105001		1-	B	g1
C 4027	AL.ELECTRO.CAP.	10uF	16V		ECEV1CS100SR	K48120001		1-	A	A3
C 4027	AL.ELECTRO.CAP.	10uF	16V		EEE1CS100SR	K48120023		93-	A	A3
C 4028	CHIP TA.CAP.	4.7uF	16V		TEMSVA1C475M-8R	K78120031		1-	B	g1
C 4029	CHIP CAP.	0.001uF	50V	B	GRM188B11H102KA01D	K22174821		1-	B	g1
C 4030	CHIP CAP.	1uF	10V	F	GRM188F11A105ZA01D	K22105001		1-	A	B2
C 4031	AL.ELECTRO.CAP.	470uF	16V		RE3-16V471MG3#	K40129066		1-	A	B3
C 4032	CHIP CAP.	56pF	50V	CH	GRM1882C1H560JA01D	K22174229		1-	B	f1
C 4033	CHIP CAP.	0.001uF	50V	B	GRM188B11H102KA01D	K22174821		1-	B	g3
C 4034	CHIP TA.CAP.	4.7uF	16V		TEMSVA1C475M-8R	K78120031		1-	B	g2
C 4035	CHIP TA.CAP.	4.7uF	16V		TEMSVA1C475M-8R	K78120031		1-	B	h2
C 4036	CHIP CAP.	0.01uF	25V	B	GRM39B103K25PT	K22144803		1-	B	g4
C 4037	CHIP TA.CAP.	2.2uF	25V		TEMSVA1E225M-8R	K78140020		1-	B	h4
C 4038	CHIP CAP.	0.1uF	16V	B	GRM188B11C104KA01D	K22124805		1-	B	f1
C 4039	CHIP TA.CAP.	4.7uF	16V		TEMSVA1C475M-8R	K78120031		1-	B	g2
C 4040	CHIP CAP.	330pF	50V	CH	GRM1882C1H331JA01D	K22174253		1-	B	g2
C 4041	CHIP TA.CAP.	33uF	10V		TEMSVB21A336M-8R	K78100047		1-	B	g1
C 4042	CHIP CAP.	0.001uF	50V	B	GRM188B11H102KA01D	K22174821		1-	B	h4
C 4043	CHIP CAP.	330pF	50V	CH	GRM1882C1H331JA01D	K22174253		1-	B	g2
C 4044	CHIP CAP.	0.001uF	50V	B	GRM188B11H102KA01D	K22174821		1-	B	g2
C 4045	CHIP TA.CAP.	4.7uF	16V		TEMSVA1C475M-8R	K78120031		1-	B	g2
C 4046	CHIP TA.CAP.	4.7uF	16V		TEMSVA1C475M-8R	K78120031		1-	B	h4
C 4047	CHIP CAP.	1uF	10V	F	GRM188F11A105ZA01D	K22105001		1-	B	h2
C 4048	CHIP CAP.	0.047uF	16V	B	GRM39B473K16PT	K22124804		1-	B	g4
C 4049	CHIP TA.CAP.	4.7uF	16V		TEMSVA1C475M-8R	K78120031		1-	A	B2
C 4050	CHIP TA.CAP.	4.7uF	16V		TEMSVA1C475M-8R	K78120031		1-	B	g2
C 4051	CHIP CAP.	0.022uF	25V	B	GRM39B223K25PT	K22144807		1-	B	f1
C 4052	CHIP CAP.	100pF	50V	CH	GRM1882C1H101JA01D	K22174235		1-	B	g6
C 4053	CHIP CAP.	100pF	50V	CH	GRM1882C1H101JA01D	K22174235		1-	B	g6
C 4054	CHIP CAP.	100pF	50V	CH	GRM1882C1H101JA01D	K22174235		1-	B	g6
C 4055	CHIP CAP.	100pF	50V	CH	GRM1882C1H101JA01D	K22174235		1-	B	h6
C 4055	CHIP CAP.	220pF	50V	CH	GRM1882C1H221JA01D	K22174243		19-	B	h6
C 4056	CHIP CAP.	330pF	50V	CH	GRM1882C1H331JA01D	K22174253		1-	B	g2
C 4057	CHIP CAP.	0.1uF	16V	B	GRM188B11C104KA01D	K22124805		1-	B	g3
C 4058	CHIP CAP.	330pF	50V	CH	GRM1882C1H331JA01D	K22174253		1-	B	g2

CNTL Unit

REF.	DESCRIPTION	VALUE	V/W	TOL.	MFR'S DESIG	VXSTD P/N	VERS.	LOT.	SIDE	LAYADR
C 4059	CHIP CAP.	100pF	50V	CH	GRM1882C1H101JA01D	K22174235		1-	B	f1
C 4060	CHIP CAP.	0.1uF	16V	B	GRM188B11C104KA01D	K22124805		1-	B	f2
C 4061	CHIP CAP.	100pF	50V	CH	GRM1882C1H101JA01D	K22174235		1-	B	g6
C 4062	CHIP CAP.	100pF	50V	CH	GRM1882C1H101JA01D	K22174235		1-	B	g6
C 4063	CHIP CAP.	100pF	50V	CH	GRM1882C1H101JA01D	K22174235		1-	B	f1
C 4064	CHIP CAP.	100pF	50V	CH	GRM1882C1H101JA01D	K22174235		1-	B	f1
C 4065	CHIP CAP.	100pF	50V	CH	GRM1882C1H101JA01D	K22174235		1-	B	d6
C 4066	CHIP CAP.	100pF	50V	CH	GRM1882C1H101JA01D	K22174235		1-	B	d6
C 4067	CHIP CAP.	100pF	50V	CH	GRM1882C1H101JA01D	K22174235		1-	B	d6
C 4068	CHIP CAP.	100pF	50V	CH	GRM1882C1H101JA01D	K22174235		1-	B	d6
C 4069	CHIP CAP.	10pF	50V	CH	GRM1882C1H100JA01D	K22174211		1-	B	g4
C 4070	CHIP CAP.	0.01uF	25V	B	GRM39B103K25PT	K22144803		1-	B	f4
C 4071	CHIP CAP.	3pF	50V	CJ	GRM1883C1H3R0CZ01D	K22174204		1-	B	g4
C 4072	CHIP TA.CAP.	1uF	25V		TEMSVA1E105M-8R	K78140013		1-	B	f4
C 4073	CHIP CAP.	100pF	50V	CH	GRM1882C1H101JA01D	K22174235		1-	B	f1
C 4074	CHIP CAP.	100pF	50V	CH	GRM1882C1H101JA01D	K22174235		1-	B	e1
C 4075	CHIP CAP.	100pF	50V	CH	GRM1882C1H101JA01D	K22174235		1-	B	e1
C 4076	CHIP CAP.	100pF	50V	CH	GRM1882C1H101JA01D	K22174235		1-	B	e1
C 4077	CHIP CAP.	100pF	50V	CH	GRM1882C1H101JA01D	K22174235		1-	B	e1
C 4078	CHIP CAP.	100pF	50V	CH	GRM1882C1H101JA01D	K22174235		1-	B	e1
C 4079	CHIP CAP.	100pF	50V	CH	GRM1882C1H101JA01D	K22174235		1-	B	e1
C 4080	CHIP CAP.	100pF	50V	CH	GRM1882C1H101JA01D	K22174235		1-	B	e1
C 4081	CHIP CAP.	0.01uF	25V	B	GRM39B103K25PT	K22144803		1-	B	e1
C 4082	CHIP TA.CAP.	4.7uF	16V		TEMSVA1C475M-8R	K78120031		1-	B	f4
C 4083	CHIP CAP.	0.001uF	50V	B	GRM188B11H102KA01D	K22174821		1-	B	f2
C 4084	CHIP CAP.	15pF	50V	CH	GRM1882C1H150JA01D	K22174215		1-	B	f4
C 4085	CHIP TA.CAP.	4.7uF	16V		TEMSVA1C475M-8R	K78120031		1-	B	f2
C 4086	CHIP CAP.	0.01uF	25V	B	GRM39B103K25PT	K22144803		1-	B	f4
C 4087	CHIP CAP.	100pF	50V	CH	GRM1882C1H101JA01D	K22174235		1-	B	d6
C 4088	CHIP CAP.	100pF	50V	CH	GRM1882C1H101JA01D	K22174235		1-	B	d6
C 4088	CHIP CAP.	220pF	50V	CH	GRM1882C1H221JA01D	K22174243		19-	B	d6
C 4089	CHIP CAP.	100pF	50V	CH	GRM1882C1H101JA01D	K22174235		1-	B	d6
C 4090	CHIP CAP.	100pF	50V	CH	GRM1882C1H101JA01D	K22174235		1-	B	e1
C 4091	CHIP CAP.	0.1uF	16V	B	GRM188B11C104KA01D	K22124805		1-	B	e3
C 4092	CHIP CAP.	0.1uF	16V	B	GRM188B11C104KA01D	K22124805		1-	B	f3
C 4093	CHIP CAP.	0.1uF	16V	B	GRM188B11C104KA01D	K22124805		1-	B	f3
C 4094	CHIP CAP.	0.022uF	25V	B	GRM39B223K25PT	K22144807		1-	B	e5
C 4095	CHIP CAP.	0.01uF	25V	B	GRM39B103K25PT	K22144803		1-	B	d5
C 4096	CHIP CAP.	0.1uF	16V	B	GRM188B11C104KA01D	K22124805		1-	B	e5
C 4097	CHIP TA.CAP.	1uF	25V		TEMSVA1E105M-8R	K78140013		1-	A	D2
C 4098	CHIP CAP.	0.022uF	25V	B	GRM39B223K25PT	K22144807		1-	B	c4
C 4099	CHIP CAP.	0.0039uF	50V	B	GRM188B11H392KA01D	K22174830		6-	B	e2
C 4100	CHIP TA.CAP.	1uF	25V		TEMSVA1E105M-8R	K78140013		1-	B	e4
C 4101	CHIP CAP.	0.1uF	16V	B	GRM188B11C104KA01D	K22124805		1-	B	c5
C 4102	CHIP CAP.	0.001uF	50V	B	GRM188B11H102KA01D	K22174821		1-	A	D2
C 4104	CHIP TA.CAP.	1uF	25V		TEMSVA1E105M-8R	K78140013		1-	B	e4
C 4105	CHIP CAP.	0.015uF	25V	B	GRM39B153K25PT	K22144805		6-	B	e2
C 4106	CHIP CAP.	0.001uF	50V	B	GRM188B11H102KA01D	K22174821		1-	B	e4
C 4107	CHIP CAP.	1uF	10V	B	GRM40B105K10PT	K22100802		1-	B	c4
C 4108	CHIP CAP.	0.001uF	50V	B	GRM188B11H102KA01D	K22174821		1-	B	e4
C 4110	CHIP CAP.	0.0015uF	50V	B	GRM188B11H152KA01D	K22174811		1-	B	e1
C 4111	CHIP CAP.	1uF	10V	B	GRM40B105K10PT	K22100802		1-	B	e4
C 4112	CHIP CAP.	100pF	50V	CH	GRM1882C1H101JA01D	K22174235		1-	B	c6
C 4113	CHIP CAP.	100pF	50V	CH	GRM1882C1H101JA01D	K22174235		1-	B	c6
C 4114	CHIP CAP.	100pF	50V	CH	GRM1882C1H101JA01D	K22174235		1-	B	c6
C 4115	CHIP CAP.	100pF	50V	CH	GRM1882C1H101JA01D	K22174235		1-	B	g6
C 4116	CHIP CAP.	0.015uF	25V	B	GRM39B153K25PT	K22144805		6-	A	E2
C 4117	CHIP CAP.	470pF	50V	CH	GRM1882C1H471JA01D	K22174249		1-	B	d4
C 4118	CHIP TA.CAP.	10uF	10V		TEMSVA1A106M-8R	K78100028		1-	B	e2
C 4119	CHIP CAP.	0.0033uF	50V	B	GRM188B11H332KA01D	K22174815		1-	A	E1
C 4120	CHIP TA.CAP.	0.1uF	35V		TESVA1V104M1-8R	K78160025		1-	A	E2
C 4120	CHIP CAP.	0.1uF	16V	B	GRM188B11C104KA01D	K22124805		6-	A	E2
C 4121	CHIP CAP.	0.1uF	16V	B	GRM188B11C104KA01D	K22124805		1-	B	c5
C 4122	CHIP CAP.	0.001uF	50V	B	GRM188B11H102KA01D	K22174821		1-	B	c6
C 4124	CHIP TA.CAP.	1.5uF	20V		TEMSVA1D155M-8R	K78130013		1-	B	e4

REF.	DESCRIPTION	VALUE	V/W	TOL.	MFR'S DESIG	VXSTD P/N	VERS.	LOT.	SIDE	LAYADR
C 4125	CHIP CAP.	0.0015uF	50V	B	GRM188B11H152KA01D	K22174811		1-	B	d1
C 4126	CHIP CAP.	0.1uF	16V	B	GRM188B11C104KA01D	K22124805		1-	B	g5
C 4127	CHIP CAP.	1uF	10V	B	GRM40B105K10PT	K22100802		1-	B	e4
C 4129	CHIP CAP.	470pF	50V	CH	GRM1882C1H471JA01D	K22174249		1-	A	C5
C 4130	CHIP TA.CAP.	1.5uF	20V		TEMSVA1D155M-8R	K78130013		1-	A	E3
C 4131	CHIP CAP.	33pF	50V	CH	GRM1882C1H330JA01D	K22174223		1-	B	e2
C 4132	CHIP TA.CAP.	1uF	25V		TEMSVA1E105M-8R	K78140013		1-	B	d4
C 4133	CHIP CAP.	100pF	50V	CH	GRM1882C1H101JA01D	K22174235		1-	B	g6
C 4134	CHIP CAP.	100pF	50V	CH	GRM1882C1H101JA01D	K22174235		1-	B	f6
C 4135	CHIP CAP.	100pF	50V	CH	GRM1882C1H101JA01D	K22174235		1-	B	f6
C 4136	CHIP CAP.	0.1uF	16V	B	GRM188B11C104KA01D	K22124805		1-	B	d4
C 4137	CHIP CAP.	0.001uF	50V	B	GRM188B11H102KA01D	K22174821		1-	B	d5
C 4138	CHIP CAP.	0.0047uF	50V	B	GRM188B11H472KA01D	K22174817		1-	A	F1
C 4139	CHIP TA.CAP.	1uF	25V		TEMSVA1E105M-8R	K78140013		1-	B	e1
C 4140	CHIP TA.CAP.	4.7uF	16V		TEMSVA1C475M-8R	K78120031		1-	B	c3
C 4141	CHIP CAP.	330pF	50V	CH	GRM1882C1H331JA01D	K22174253		1-	B	d2
C 4142	CHIP CAP.	0.001uF	50V	B	GRM188B11H102KA01D	K22174821		1-	B	e1
C 4143	CHIP CAP.	0.1uF	16V	B	GRM188B11C104KA01D	K22124805		1-	A	D3
C 4144	CHIP CAP.	0.01uF	25V	B	GRM39B103K25PT	K22144803		1-	B	d3
C 4145	CHIP TA.CAP.	0.1uF	35V		TESVA1V104M1-8R	K78160025		1-	B	c4
C 4145	CHIP CAP.	0.1uF	16V	B	GRM188B11C104KA01D	K22124805		6-	B	c4
C 4146	CHIP CAP.	1uF	10V	F	GRM188F11A105ZA01D	K22105001		1-	A	F3
C 4147	CHIP CAP.	0.1uF	16V	B	GRM188B11C104KA01D	K22124805		1-	A	G5
C 4148	AL.ELECTRO.CAP.	100uF	10V		RC3-10V101MF0#	K40109030		1-	A	D1
C 4148	AL.ELECTRO.CAP.	100uF	16V		ECEV1CA101WP	K48120012		6-	A	D1
C 4149	CHIP CAP.	68pF	50V	CH	GRM1882C1H680JA01D	K22174231		1-	B	e2
C 4150	CHIP CAP.	0.1uF	16V	B	GRM188B11C104KA01D	K22124805		1-	B	d2
C 4151	CHIP TA.CAP.	47uF	6.3V		TEMSVB20J476M-8R	K78080048		1-	B	d1
C 4152	CHIP TA.CAP.	4.7uF	16V		TEMSVA1C475M-8R	K78120031		1-	B	d1
C 4153	CHIP CAP.	330pF	50V	CH	GRM1882C1H331JA01D	K22174253		1-	A	F4
C 4154	CHIP CAP.	0.1uF	16V	B	GRM188B11C104KA01D	K22124805		1-	B	d2
C 4155	CHIP CAP.	0.001uF	50V	B	GRM188B11H102KA01D	K22174821		1-	B	d1
C 4156	AL.ELECTRO.CAP.	22uF	16V		ECEV1CA220SR	K48120002		1-	A	E2
C 4156	AL.ELECTRO.CAP.	22uF	16V		EEE1CA220SR	K48120024		93-	A	E2
C 4157	CHIP TA.CAP.	4.7uF	16V		TEMSVA1C475M-8R	K78120031		1-	B	e3
C 4158	CHIP CAP.	15pF	50V	CH	GRM1882C1H150JA01D	K22174215		1-	B	b5
C 4161	CHIP TA.CAP.	1uF	25V		TEMSVA1E105M-8R	K78140013		1-	B	c5
C 4162	CHIP CAP.	1uF	10V	F	GRM188F11A105ZA01D	K22105001		1-	B	d2
C 4162	CHIP TA.CAP.	10uF	10V		TEMSVA1A106M-8R	K78100028		6-	B	d2
C 4163	CHIP CAP.	0.001uF	50V	B	GRM188B11H102KA01D	K22174821		1-	B	c5
C 4164	CHIP CAP.	0.015uF	25V	B	GRM39B153K25PT	K22144805		1-	B	b5
C 4165	CHIP CAP.	0.015uF	25V	B	GRM39B153K25PT	K22144805		1-	B	b5
C 4166	CHIP TA.CAP.	10uF	10V		TEMSVA1A106M-8R	K78100028		1-	B	c5
C 4167	CHIP TA.CAP.	4.7uF	16V		TEMSVA1C475M-8R	K78120031		1-	A	F3
C 4168	CHIP TA.CAP.	4.7uF	16V		TEMSVA1C475M-8R	K78120031		1-	A	F3
C 4169	CHIP CAP.	0.001uF	50V	B	GRM188B11H102KA01D	K22174821		1-	A	F3
C 4170	CHIP TA.CAP.	4.7uF	16V		TEMSVA1C475M-8R	K78120031		1-	B	c2
C 4171	CHIP CAP.	1uF	10V	F	GRM188F11A105ZA01D	K22105001		1-	B	d1
C 4171	CHIP TA.CAP.	10uF	10V		TEMSVA1A106M-8R	K78100028		6-	B	d1
C 4172	CHIP CAP.	0.015uF	25V	B	GRM39B153K25PT	K22144805		1-	B	b5
C 4173	CHIP CAP.	0.0018uF	50V	B	GRM188B11H182KA01D	K22174812		1-	A	F3
C 4174	CHIP CAP.	0.0039uF	50V	B	GRM188B11H392KA01D	K22174830		1-	A	F3
C 4175	CHIP CAP.	0.0039uF	50V	B	GRM188B11H392KA01D	K22174830		1-	A	F3
C 4176	CHIP TA.CAP.	4.7uF	16V		TEMSVA1C475M-8R	K78120031		1-	B	c2
C 4177	CHIP TA.CAP.	4.7uF	16V		TEMSVA1C475M-8R	K78120031		1-	A	E2
C 4178	CHIP CAP.	0.0015uF	50V	B	GRM188B11H152KA01D	K22174811		1-	A	F3
C 4180	CHIP CAP.	0.0022uF	50V	B	GRM188B11H222KA01D	K22174822		1-	B	c3
C 4181	CHIP CAP.	100pF	50V	CH	GRM1882C1H101JA01D	K22174235		1-	A	G3
C 4182	CHIP TA.CAP.	4.7uF	16V		TEMSVA1C475M-8R	K78120031		1-	B	c3
C 4183	CHIP TA.CAP.	1uF	25V		TEMSVA1E105M-8R	K78140013		1-	A	F2
C 4183	CHIP CAP.	1uF	10V	B	GRM40B105K10PT	K22100802		6-	A	F2
C 4184	CHIP TA.CAP.	4.7uF	16V		TEMSVA1C475M-8R	K78120031		1-	B	c2
C 4185	CHIP CAP.	0.1uF	16V	B	GRM188B11C104KA01D	K22124805		1-	B	b4
C 4186	CHIP TA.CAP.	4.7uF	16V		TEMSVA1C475M-8R	K78120031		1-	B	c2
C 4187	CHIP CAP.	82pF	50V	CH	GRM1882C1H820JA01D	K22174233		1-	B	c3

CNTL Unit

REF.	DESCRIPTION	VALUE	V/W	TOL.	MFR'S DESIG	VXSTD P/N	VERS.	LOT.	SIDE	LAYADR
C 4188	CHIP CAP.	0.01uF	25V	B	GRM39B103K25PT	K22144803		1-	B	c4
C 4189	CHIP TA.CAP.	10uF	10V		TEMSVA1A106M-8R	K78100028		1-	B	c3
C 4190	CHIP CAP.	0.015uF	25V	B	GRM39B153K25PT	K22144805		1-	B	b5
C 4191	CHIP CAP.	560pF	50V	B	ECUV1H561KBV	K22179611		1-	B	c3
C 4192	CHIP CAP.	0.1uF	16V	B	GRM188B11C104KA01D	K22124805		1-	A	F1
C 4193	CHIP TA.CAP.	4.7uF	16V		TEMSVA1C475M-8R	K78120031		1-39	B	c1
C 4193	CHIP TA.CAP.	1uF	25V		TEMSVA1E105M-8R	K78140013	VERSION A	40-	B	c1
C 4193	CHIP TA.CAP.	4.7uF	16V		TEMSVA1C475M-8R	K78120031	VERSION C	40-	B	c1
C 4194	CHIP TA.CAP.	1uF	25V		TEMSVA1E105M-8R	K78140013		1-	B	c3
C 4195	CHIP CAP.	150pF	50V	CH	GRM1882C1H151JA01D	K22174239		1-	B	c1
C 4196	CHIP CAP.	0.1uF	16V	B	GRM188B11C104KA01D	K22124805		1-	B	c2
C 4197	CHIP CAP.	0.015uF	25V	B	GRM39B153K25PT	K22144805		1-	B	b5
C 4198	CHIP CAP.	0.001uF	50V	B	GRM188B11H102KA01D	K22174821		1-	B	c3
C 4199	CHIP TA.CAP.	1uF	25V		TEMSVA1E105M-8R	K78140013		1-	A	F2
C 4200	CHIP CAP.	47pF	50V	CH	GRM1882C1H470JA01D	K22174227		1-	B	c2
C 4201	CHIP CAP.	0.01uF	25V	B	GRM39B103K25PT	K22144803		1-	A	G4
C 4202	CHIP CAP.	0.001uF	50V	B	GRM188B11H102KA01D	K22174821		1-	B	a3
C 4203	CHIP CAP.	0.01uF	25V	B	GRM39B103K25PT	K22144803		1-	B	c4
C 4204	CHIP CAP.	0.001uF	50V	B	GRM188B11H102KA01D	K22174821		1-	B	c3
C 4205	CHIP CAP.	0.01uF	25V	B	GRM39B103K25PT	K22144803		1-	B	c4
C 4206	CHIP CAP.	150pF	50V	CH	GRM1882C1H151JA01D	K22174239		1-	B	b4
C 4207	CHIP CAP.	0.001uF	50V	B	GRM188B11H102KA01D	K22174821		1-	A	H1
C 4208	CHIP CAP.	0.001uF	50V	B	GRM188B11H102KA01D	K22174821		1-	A	G4
C 4209	CHIP CAP.	0.0015uF	50V	B	GRM188B11H152KA01D	K22174811		1-	B	b4
C 4210	CHIP CAP.	100pF	50V	CH	GRM1882C1H101JA01D	K22174235		1-	B	a3
C 4211	CHIP CAP.	15pF	50V	CH	GRM1882C1H150JA01D	K22174215		1-	B	c3
C 4212	CHIP CAP.	0.0022uF	50V	B	GRM188B11H222KA01D	K22174822		1-	B	c3
C 4213	CHIP TA.CAP.	10uF	10V		TEMSVA1A106M-8R	K78100028		1-	A	F2
C 4214	CHIP CAP.	0.001uF	50V	B	GRM188B11H102KA01D	K22174821		1-	B	c4
C 4215	CHIP CAP.	0.1uF	16V	B	GRM188B11C104KA01D	K22124805		1-	A	G5
C 4216	CHIP CAP.	100pF	50V	CH	GRM1882C1H101JA01D	K22174235		1-	B	d1
C 4217	CHIP CAP.	100pF	50V	CH	GRM1882C1H101JA01D	K22174235		1-	B	c1
C 4219	CHIP CAP.	100pF	50V	CH	GRM1882C1H101JA01D	K22174235		1-	B	c1
C 4220	CHIP CAP.	100pF	50V	CH	GRM1882C1H101JA01D	K22174235		1-	B	c1
C 4221	CHIP CAP.	100pF	50V	CH	GRM1882C1H101JA01D	K22174235		1-	B	c1
C 4222	CHIP TA.CAP.	1uF	25V		TEMSVA1E105M-8R	K78140013		1-	B	c4
C 4223	CHIP TA.CAP.	10uF	10V		TEMSVA1A106M-8R	K78100028		1-	B	c1
C 4224	CHIP CAP.	0.1uF	16V	B	GRM188B11C104KA01D	K22124805		1-	A	H4
C 4225	AL.ELECTRO.CAP.	10uF	35V		RC2-35V100MD1#-F1	K40169025		1-	A	G2
C 4226	CHIP CAP.	150pF	50V	CH	GRM1882C1H151JA01D	K22174239		1-	B	c2
C 4227	CHIP CAP.	0.0033uF	50V	B	GRM188B11H332KA01D	K22174815		1-	A	I4
C 4228	CHIP CAP.	270pF	50V	CH	GRM1882C1H271JA01D	K22174251		1-	A	G1
C 4229	CHIP TA.CAP.	4.7uF	16V		TEMSVA1C475M-8R	K78120031		1-	B	c3
C 4230	AL.ELECTRO.CAP.	10uF	16V		ECEV1CS100SR	K48120001		1-	A	H4
C 4230	AL.ELECTRO.CAP.	10uF	16V		EEE1CS100SR	K48120023		93-	A	H4
C 4231	CHIP CAP.	330pF	50V	CH	GRM1882C1H331JA01D	K22174253		1-	B	b4
C 4232	CHIP CAP.	0.001uF	50V	B	GRM188B11H102KA01D	K22174821		1-	B	a1
C 4233	CHIP TA.CAP.	10uF	10V		TEMSVA1A106M-8R	K78100028		1-	B	c4
C 4234	CHIP CAP.	680pF	25V	CH	GRM39CH681J25PT	K22144203		1-	A	G1
C 4235	CHIP TA.CAP.	1uF	25V		TEMSVA1E105M-8R	K78140013		1-	B	c2
C 4236	CHIP CAP.	560pF	50V	B	ECUV1H561KBV	K22179611		1-	B	b4
C 4237	CHIP CAP.	0.001uF	50V	B	GRM188B11H102KA01D	K22174821		1-	A	F2
C 4238	CHIP TA.CAP.	1uF	25V		TEMSVA1E105M-8R	K78140013		1-	B	a2
C 4239	CHIP CAP.	0.001uF	50V	B	GRM188B11H102KA01D	K22174821		1-	B	a3
C 4240	CHIP CAP.	33pF	50V	CH	GRM1882C1H330JA01D	K22174223		1-	B	b5
C 4241	CHIP CAP.	0.001uF	50V	B	GRM188B11H102KA01D	K22174821		1-	A	F2
C 4242	CHIP CAP.	0.001uF	50V	B	GRM188B11H102KA01D	K22174821		1-	B	a2
C 4243	CHIP CAP.	330pF	50V	CH	GRM1882C1H331JA01D	K22174253		1-	B	c3
C 4244	CHIP CAP.	0.0012uF	50V	B	GRM188B11H122KA01D	K22174826		1-	A	G2
C 4245	CHIP CAP.	0.001uF	50V	B	GRM188B11H102KA01D	K22174821		1-	B	a3
C 4246	CHIP CAP.	330pF	50V	CH	GRM1882C1H331JA01D	K22174253		1-	B	b4
C 4247	AL.ELECTRO.CAP.	470uF	16V		RE3-16V471MG3#	K40129066		1-	A	I4
C 4248	CHIP CAP.	330pF	50V	CH	GRM1882C1H331JA01D	K22174253		1-	B	b4
C 4249	CHIP CAP.	220pF	50V	CH	GRM1882C1H221JA01D	K22174243		1-	A	G2
C 4250	AL.ELECTRO.CAP.	10uF	35V		RC2-35V100MD1#-F1	K40169025		1-	A	G3

REF.	DESCRIPTION	VALUE	V/W	TOL.	MFR'S DESIG	VXSTD P/N	VERS.	LOT.	SIDE	LAYADR
C 4251	CHIP CAP.	0.1uF	25V	B	GRM40B104M25PT	K22140811		1-	B	a4
C 4252	CHIP CAP.	120pF	50V	CH	GRM1882C1H121JA01D	K22174237		1-	A	G2
C 4253	CHIP CAP.	0.001uF	50V	B	GRM188B11H102KA01D	K22174821		1-	B	a2
C 4254	CHIP CAP.	0.001uF	50V	B	GRM188B11H102KA01D	K22174821		1-	B	a2
C 4255	CHIP CAP.	0.001uF	50V	B	GRM188B11H102KA01D	K22174821		1-	B	a5
C 4256	CHIP CAP.	0.001uF	50V	B	GRM188B11H102KA01D	K22174821		1-	B	a2
C 4257	CHIP CAP.	0.001uF	50V	B	GRM188B11H102KA01D	K22174821		1-	B	a2
C 4258	AL.ELECTRO.CAP.	470uF	16V		RE3-16V471MG3#	K40129066		1-	A	H5
C 4259	CHIP CAP.	0.0022uF	50V	B	GRM188B11H222KA01D	K22174822		1-	A	G2
C 4260	CHIP CAP.	0.0047uF	50V	B	ECJ1VB1H472K	K22179622		6-	A	E2
C 4261	CHIP CAP.	0.001uF	50V	B	GRM188B11H102KA01D	K22174821		6-	A	E2
C 4263	CHIP CAP.	220pF	50V	CH	GRM1882C1H221JA01D	K22174243		6-	A	E2
C 4265	CHIP CAP.	0.012uF	50V	B	GRM188B11H123KA01D	K22174825		6-	B	d2
C 4266	CHIP CAP.	330pF	50V	CH	GRM1882C1H331JA01D	K22174253		6-	A	E2
C 4267	CHIP CAP.	56pF	50V	CH	GRM1882C1H560JA01D	K22174229		6-	A	E3
C 4269	CHIP CAP.	0.033uF	16V	B	ECJ1VB1C333K	K22129515		6-	B	d2
C 4270	CHIP CAP.	0.0015uF	50V	B	GRM188B11H152KA01D	K22174827		6-	A	E2
C 4272	CHIP TA.CAP.	10uF	10V		TEMSVA1A106M-8R	K78100028		6-	B	e3
C 4273	CHIP CAP.	0.022uF	25V	B	GRM39B223K25PT	K22144807		6-	A	E3
C 4274	CHIP CAP.	0.056uF	16V	B	GRM188B11C563KA01D	K22124807		6-	A	E3
C 4275	CHIP CAP.	0.0027uF	50V	B	ECJ1VB1H272K	K22179619		6-	A	E3
C 4276	CHIP TA.CAP.	10uF	10V		TEMSVA1A106M-8R	K78100028		6-	B	d3
C 4277	CHIP CAP.	0.0018uF	50V	B	ECJ1VB1H182K	K22179617		6-	A	F3
C 4278	CHIP CAP.	0.056uF	16V	B	GRM188B11C563KA01D	K22124807		6-	B	d3
C 4279	CHIP TA.CAP.	1uF	25V		TEMSVA1E105M-8R	K78140013		6-	B	d4
C 4280	CHIP CAP.	0.001uF	50V	B	GRM188B11H102KA01D	K22174821		6-	B	d3
C 4281	CHIP TA.CAP.	1uF	25V		TEMSVA1E105M-8R	K78140013		6-	B	d3
C 4282	CHIP CAP.	0.001uF	50V	B	GRM188B11H102KA01D	K22174821		6-	B	d4
C 4283	CHIP TA.CAP.	10uF	10V		TEMSVA1A106M-8R	K78100028		6-	B	d4
C 4284	CHIP TA.CAP.	1uF	25V		TEMSVA1E105M-8R	K78140013		6-	A	E2
C 4285	CHIP CAP.	0.001uF	50V	B	GRM188B11H102KA01D	K22174821		6-	B	e2
C 4287	CHIP CAP.	0.033uF	16V	B	ECJ1VB1C333K	K22129515		6-	B	
D 4001	DIODE				DA204K T146	G2070388		1-	B	h2
D 4002	DIODE				DA204K T146	G2070388		1-	B	h1
D 4003	DIODE				DA204K T146	G2070388		1-	B	h1
D 4004	DIODE				DA204K T146	G2070388		1-	B	h1
D 4005	DIODE				DA204K T146	G2070388		1-	B	h1
D 4006	DIODE				DA204K T146	G2070388		1-	A	B2
D 4007	DIODE				D1F20-4063	G2070474		1-	B	h3
D 4008	DIODE				HZM7C-TR	G2070070		1-	B	h3
D 4008	DIODE				HZM7.5NB2 TR	G2070864		49-	B	h3
D 4009	DIODE				DA204K T146	G2070388		1-	A	B4
D 4010	DIODE				1SS355 TE-17	G2070470		1-	B	h4
D 4011	DIODE				1SS355 TE-17	G2070470		1-	B	h3
D 4012	DIODE				DA204K T146	G2070388		1-	A	B5
D 4013	DIODE				1SS355 TE-17	G2070470		1-	A	B4
D 4014	DIODE				1SS355 TE-17	G2070470		1-	B	f1
D 4015	DIODE				MA729-(TX)	G2070320		1-	B	f4
D 4016	DIODE				DA204K T146	G2070388		1-	A	B5
D 4017	DIODE				DA204K T146	G2070388		1-	B	e6
D 4018	DIODE				DA204K T146	G2070388		1-	B	d5
D 4019	DIODE				DA204K T146	G2070388		1-	A	F5
D 4020	DIODE				DA204K T146	G2070388		1-	A	C5
D 4021	DIODE				DA204K T146	G2070388		1-	B	e4
D 4022	DIODE				DA204K T146	G2070388		1-	A	C5
D 4023	DIODE				DA204K T146	G2070388		1-	A	C5
D 4024	DIODE				DA204K T146	G2070388		1-	B	b3
D 4025	DIODE				1SS184 TE85R	G2070009		1-	B	a3
D 4026	DIODE				1SS184 TE85R	G2070009		1-	B	a2
D 4027	SURGE ABSORBER				ERZ-V07D121	Q9000604		1-	A	H1
D 4028	SURGE ABSORBER				ERZ-V07D121	Q9000604		1-	A	H3
D 4029	SURGE ABSORBER				ERZ-V07D121	Q9000604		1-	A	I1
D 4030	SURGE ABSORBER				ERZ-V07D121	Q9000604		1-	A	H3
D 4031	SURGE ABSORBER				ERZ-V07D121	Q9000604		1-	A	H2
D 4032	SURGE ABSORBER				ERZ-V07D121	Q9000604		1-	A	H2

CNTL Unit

REF.	DESCRIPTION	VALUE	V/W	TOL.	MFR'S DESIG	VXSTD P/N	VERS.	LOT.	SIDE	LAYADR
D 4033	SURGE ABSORBER				ERZ-V07D121	Q9000604		1-	A	H2
D 4034	SURGE ABSORBER				ERZ-V07D121	Q9000604		1-	A	H2
D 4036	DIODE				MA143-(TX)	G2070536		1-	A	D2
D 4037	DIODE				MA143-(TX)	G2070536		1-	A	D2
D 4038	DIODE				1SS355 TE-17	G2070470		1-5		
D 4039	DIODE				1SS355 TE-17	G2070470		1-5		
D 4040	DIODE				DA204K T146	G2070388		6-	B	d3
F 4001	CHIP FUSE	3A			F0805B3R00FWTR	Q0000082		1-	A	C1
J 4001	CONNECTOR				B26B-PHDSS	P0091239		1-	A	B1
J 4002	CONNECTOR				SB20-08WS	P0090615		1-	A	B3
J 4003	CONNECTOR				SB20-14WS	P0090656		1-	A	B6
J 4004	CONNECTOR				SB20-06WS	P0090613		1-	A	C1
J 4005	CONNECTOR				SB20-06WS	P0090613		1-	A	B5
J 4006	CONNECTOR				SB20-15WS	P0091093		1-	A	E6
J 4007	CONNECTOR				SB20-14WS	P0090656		1-	A	D1
J 4008	CONNECTOR				SB20-13WS	P0090620		1-	A	F1
J 4009	CONNECTOR				B8B-PH-K-S	P0090402		1-	A	I2
J 4010	CONNECTOR				SB20-03WS	P0090610		1-	A	H5
J 4011	CONNECTOR				SB20-02WS	P0090609		1-	A	H5
JP4051	WIRE ASSY				GRN 55 2/2	T50505500		3-5		
JP4052	WIRE ASSY				GRN 25 2/2	T50502500		3-5		
JP4053	WIRE ASSY				GRN 20 2/2	T50502000		3-5		
JP4054	WIRE ASSY				GRN 50 2/2	T50505000		3-5		
JP4055	WIRE ASSY				GRN 25 2/2	T50502500		3-5		
JP4056	WIRE ASSY				RED 30 (2)/(2)	T9318124		3-5		
JP4057	WIRE ASSY				BLK 40 (2)/(2)	T9318125		3-5		
JP4058	WIRE ASSY				YEL 40 (2)/(2)	T9318126		3-5		
JP4059	WIRE ASSY				ORG 80 (2)/(2)	T9318127		3-5		
JP4060	WIRE ASSY				VIO 60 (3)/(3)	T9318128		3-5		
JP4061	WIRE ASSY				GRN 30 5/5	T50503020		3-5		
L 4006	M.RFC	2.7uH			LK1608 2R7K-T	L1690848		1-	B	g4
NF4001	EMI FILTER				DSS706-351D221M25-50	Q9000642		1-	A	B1
NF4002	EMI FILTER				DSS706-351D221M25-50	Q9000642		1-	A	B1
NF4003	EMI FILTER				DSS706-351D221M25-50	Q9000642		1-	A	B1
NF4004	EMI FILTER				DSS706-351D221M25-50	Q9000642		1-	A	B1
NF4005	EMI FILTER				DSS706-351D221M25-50	Q9000642		1-	A	B2
Q 4001	IC				AN6541	G1091146		1-	A	A5
Q 4001	IC				UPC2409AHF	G1092259		6-	A	A5
Q 4002	IC				UPC78M05AHF	G1092314		1-	A	A2
Q 4003	TRANSISTOR				DTC144EK T146	G3070033		1-	B	g3
Q 4004	IC				AN8005M-(E1)	G1091454		1-	B	h4
Q 4005	IC				RH5VL45AA-T1	G1090966		1-	A	B4
Q 4006	TRANSISTOR				FMG2 T148	G3070015		1-	B	h2
Q 4007	TRANSISTOR				2SA1586Y TE85R	G3115867Y		1-	A	B3
Q 4008	IC				NM93C86AM8(TAPING)	G1092512		1-	A	C4
Q 4008	IC				M93C86-WMN6T	G1094101		73-	A	C4
Q 4009	TRANSISTOR				FMG2 T148	G3070015		1-	B	f2
Q 4010	TRANSISTOR				FMG2 T148	G3070015		1-	B	f1
Q 4011	TRANSISTOR				FMG2 T148	G3070015		1-	B	d1
Q 4012	IC				HD64F3337YF16(FLASH)	G1092971		1-	A	C3
Q 4012	IC				DF3337YF16(FLASH)	G1093352		9-	A	C3
Q 4012	IC				HD64F3337YF16(FLASH)	G1092971		18-	A	C3
Q 4013	TRANSISTOR				2SC4116GR TE85R	G3341167G		1-	B	f4
Q 4014	IC				NJM2902M-TE1	G1093092		1-	A	D2
Q 4014	IC				NJM2902V-TE1	G1091679		6-	A	D2
Q 4015	IC				M62354FP-75NC	G1091842		1-	A	D2
Q 4016	IC				NJM2902M-TE1	G1093092		1-	A	G4
Q 4016	IC				NJM2902V-TE1	G1091679		6-	A	G4
Q 4017	IC				LC73881M-TLM	G1092755		1-	B	e5
Q 4018	IC				NJM2902M-TE1	G1093092		1-	A	G2
Q 4018	IC				NJM2902V-TE1	G1091679		6-	A	G2
Q 4019	IC				NJM2902M-TE1	G1093092		1-	A	G1
Q 4019	IC				NJM2902V-TE1	G1091679		6-	A	G1
Q 4020	IC				NJM2902M-TE1	G1093092		1-	A	G3
Q 4020	IC				NJM2902V-TE1	G1091679		6-	A	G3

REF.	DESCRIPTION	VALUE	V/W	TOL.	MFR'S DESIG	VXSTD P/N	VERS.	LOT.	SIDE	LAYADR
Q 4021	IC				NJM2902M-TE1	G1093092		1-	A	G5
Q 4021	IC				NJM2902V-TE1	G1091679		6-	A	G5
Q 4022	IC				TC74HC74AF EL	G1091446		1-	B	f5
Q 4023	TRANSISTOR				DTC144EK T146	G3070033		1-	A	F5
Q 4024	IC				FX805LG-TR	G1092528		1-	A	E4
Q 4025	IC				FX803LG-TR	G1093037		1-	A	F5
Q 4026	TRANSISTOR				DTC323TK T146	G3070042		1-	B	c5
Q 4027	TRANSISTOR				2SC4116GR TE85R	G3341167G		1-	A	F3
Q 4028	TRANSISTOR				FMG2 T148	G3070015		1-	A	F2
Q 4029	IC				M51132FP 600C	G1091930		1-	A	F2
Q 4030	IC				NJU4066BM-TE2	G1093087		1-	A	F2
Q 4030	IC				NJU4066BV-TE1	G1091873		6-	A	F2
Q 4031	IC				NJM2902M-TE1	G1093092		1-	A	C1
Q 4031	IC				NJM2902V-TE1	G1091679		6-	A	C1
Q 4032	TRANSISTOR				FMG2 T148	G3070015		1-	A	F3
Q 4033	IC				NJM2902M-TE1	G1093092		1-	A	C2
Q 4033	IC				NJM2902V-TE1	G1091679		1-	A	C2
Q 4034	IC				NJM2902M-TE1	G1093092		6-	A	E2
Q 4034	IC				NJM2902V-TE1	G1091679		6-	A	E2
Q 4035	TRANSISTOR				DTC144EK T146	G3070033		1-	A	F3
Q 4036	TRANSISTOR				DTC323TK T146	G3070042		1-	A	G4
Q 4037	TRANSISTOR				DTC323TK T146	G3070042		1-	B	c3
Q 4038	TRANSISTOR				DTC323TK T146	G3070042		1-	A	F4
Q 4039	TRANSISTOR				DTA143XK T146	G3070032		1-	A	H1
Q 4040	IC				NJM2904M-TE2	G1093091		1-	A	D4
Q 4040	IC				NJM2904V-TE1	G1091677		6-	A	D4
Q 4041	PHOTO COUPLER				TLP181-GB(TPR)	G0090021		1-	A	H1
Q 4042	PHOTO COUPLER				TLP181-GB(TPR)	G0090021		1-	A	H3
Q 4043	IC				TDA2003H	G1090815		1-	A	H5
Q 4044	TRANSISTOR				DTC144EK T146	G3070033		1-	A	G1
Q 4045	IC				NJM2902V-TE1	G1091679		6-	A	E2
Q 4046	IC				NJM2902V-TE1	G1091679		6-	A	E3
R 4001	CHIP RES.	4.7	1W	5%	RMC1 4R7JTE	J24305479		1-	B	h5
R 4002	CHIP RES.	47	1W	5%	RMC1 470JTE	J24305470		1-	A	A3
R 4003	CHIP RES.	47	1W	5%	RMC1 470JTE	J24305470		1-	A	A3
R 4004	CHIP RES.	0	1/16W	5%	RMC1/16 000JATP	J24185000		1-	B	g3
R 4005	CHIP RES.	330	1/16W	5%	RMC1/16 331JATP	J24185331		1-	A	B2
R 4006	CHIP RES.	330	1/16W	5%	RMC1/16 331JATP	J24185331		1-	A	B2
R 4007	CHIP RES.	1k	1/16W	5%	RMC1/16 102JATP	J24185102		1-	A	B2
R 4008	CHIP RES.	1k	1/16W	5%	RMC1/16 102JATP	J24185102		1-	A	B2
R 4009	CHIP RES.	0	1/16W	5%	RMC1/16 000JATP	J24185000		1-5		
R 4010	CHIP RES.	0	1/16W	5%	RMC1/16 000JATP	J24185000		1-5		
R 4011	CHIP RES.	0	1/16W	5%	RMC1/16 000JATP	J24185000		1-	A	F2
R 4011	CHIP RES.	2.7k	1/16W	5%	RMC1/16 272JATP	J24185272		6-	A	F2
R 4012	CHIP RES.	1k	1/16W	5%	RMC1/16 102JATP	J24185102		1-	B	g2
R 4013	CHIP RES.	560	1/16W	5%	RMC1/16 561JATP	J24185561		1-	B	g1
R 4015	CHIP RES.	1k	1/16W	5%	RMC1/16 102JATP	J24185102		1-	A	B1
R 4016	CHIP RES.	1k	1/16W	5%	RMC1/16 102JATP	J24185102		1-	A	B1
R 4017	CHIP RES.	1k	1/16W	5%	RMC1/16 102JATP	J24185102		1-	A	B1
R 4018	CHIP RES.	1k	1/16W	5%	RMC1/16 102JATP	J24185102		1-	A	B1
R 4019	CHIP RES.	1k	1/16W	5%	RMC1/16 102JATP	J24185102		1-	A	B1
R 4020	CHIP RES.	22k	1/16W	5%	RMC1/16 223JATP	J24185223		1-	B	g3
R 4021	CHIP RES.	0	1/16W	5%	RMC1/16 000JATP	J24185000		1-	B	e2
R 4025	CHIP RES.	47k	1/16W	5%	RMC1/16 473JATP	J24185473		1-	A	C2
R 4026	CHIP RES.	10k	1/16W	5%	RMC1/16 103JATP	J24185103		1-	B	g3
R 4029	CHIP RES.	22k	1/16W	5%	RMC1/16 223JATP	J24185223		1-	A	B2
R 4031	CHIP RES.	560	1/16W	5%	RMC1/16 561JATP	J24185561		1-	B	g2
R 4033	CHIP RES.	270k	1/16W	5%	RMC1/16 274JATP	J24185274		1-	B	f2
R 4034	CHIP RES.	10k	1/16W	5%	RMC1/16 103JATP	J24185103		1-	A	C1
R 4035	CHIP RES.	15k	1/16W	5%	RMC1/16 153JATP	J24185153		1-	A	C2
R 4036	CHIP RES.	6.8k	1/16W	5%	RMC1/16 682JATP	J24185682		1-	A	C1
R 4037	CHIP RES.	10k	1/16W	5%	RMC1/16 103JATP	J24185103		1-	B	h1
R 4038	CHIP RES.	22k	1/16W	5%	RMC1/16 223JATP	J24185223		1-	B	h4
R 4039	CHIP RES.	3.9k	1/16W	5%	RMC1/16 392JATP	J24185392		1-	A	C2
R 4041	CHIP RES.	47k	1/16W	5%	RMC1/16 473JATP	J24185473		1-	B	g2

CNTL Unit

REF.	DESCRIPTION	VALUE	V/W	TOL.	MFR'S DESIG	VXSTD P/N	VERS.	LOT.	SIDE	LAYADR
R 4042	CHIP RES.	1k	1/16W	5%	RMC1/16 102JATP	J24185102		1-	B	h3
R 4043	CHIP RES.	100	1/16W	5%	RMC1/16 101JATP	J24185101		1-	A	D1
R 4044	CHIP RES.	330	1/16W	1%	RMC1/16 331FTP	J24183331		1-	A	C1
R 4045	CHIP RES.	470	1/16W	1%	RMC1/16 471FTP	J24183471		1-	A	C1
R 4046	CHIP RES.	4.7k	1/16W	5%	RMC1/16 472JATP	J24185472		1-	A	C2
R 4047	CHIP RES.	0	1/16W	5%	RMC1/16 000JATP	J24185000		1-	A	A2
R 4048	CHIP RES.	470	1/16W	1%	RMC1/16 471FTP	J24183471		1-	A	C1
R 4048	CHIP RES.	1k	1/16W	1%	RMC1/16 102FTP	J24183102		6-	A	C1
R 4049	CHIP RES.	22k	1/16W	5%	RMC1/16 223JATP	J24185223		1-	A	C2
R 4051	CHIP RES.	47k	1/16W	5%	RMC1/16 473JATP	J24185473		1-	B	g2
R 4052	CHIP RES.	22k	1/16W	5%	RMC1/16 223JATP	J24185223		1-	A	B4
R 4053	CHIP RES.	4.7k	1/16W	1%	RMC1/16 472FTP	J24183472		1-	A	C1
R 4054	CHIP RES.	4.7k	1/16W	5%	RMC1/16 472JATP	J24185472		1-	B	f1
R 4055	CHIP RES.	10k	1/16W	5%	RMC1/16 103JATP	J24185103		1-	A	C2
R 4056	CHIP RES.	8.2k	1/16W	5%	RMC1/16 822JATP	J24185822		1-	A	C2
R 4057	CHIP RES.	22k	1/16W	5%	RMC1/16 223JATP	J24185223		1-	B	g4
R 4058	CHIP RES.	10k	1/16W	5%	RMC1/16 103JATP	J24185103		1-	B	h4
R 4059	CHIP RES.	3.3k	1/16W	5%	RMC1/16 332JATP	J24185332		1-	A	C2
R 4060	CHIP RES.	5.6k	1/16W	5%	RMC1/16 562JATP	J24185562		1-	B	g3
R 4061	CHIP RES.	39k	1/16W	5%	RMC1/16 393JATP	J24185393		1-	B	f2
R 4062	CHIP RES.	4.7k	1/16W	5%	RMC1/16 472JATP	J24185472		1-	B	f1
R 4063	CHIP RES.	470k	1/16W	1%	RMC1/16 474FTP	J24183474		1-	B	f1
R 4064	CHIP RES.	47k	1/16W	5%	RMC1/16 473JATP	J24185473		1-	B	g3
R 4065	CHIP RES.	47k	1/16W	5%	RMC1/16 473JATP	J24185473		1-	B	g2
R 4066	CHIP RES.	10k	1/16W	5%	RMC1/16 103JATP	J24185103		1-	B	f1
R 4067	CHIP RES.	47k	1/16W	5%	RMC1/16 473JATP	J24185473		1-	B	g2
R 4068	CHIP RES.	470	1/16W	5%	RMC1/16 471JATP	J24185471		1-	B	g5
R 4069	CHIP RES.	470	1/16W	5%	RMC1/16 471JATP	J24185471		1-	B	g5
R 4070	CHIP RES.	10k	1/16W	5%	RMC1/16 103JATP	J24185103		1-	B	e3
R 4071	CHIP RES.	10k	1/16W	5%	RMC1/16 103JATP	J24185103		1-	A	C5
R 4072	CHIP RES.	47k	1/16W	5%	RMC1/16 473JATP	J24185473		1-	B	g2
R 4073	CHIP RES.	10k	1/16W	5%	RMC1/16 103JATP	J24185103		1-	A	C5
R 4074	CHIP RES.	330	1/16W	5%	RMC1/16 331JATP	J24185331		1-	B	g5
R 4075	CHIP RES.	0	1/16W	5%	RMC1/16 000JATP	J24185000		1-	B	f1
R 4076	CHIP RES.	330	1/16W	5%	RMC1/16 331JATP	J24185331		1-	B	g5
R 4077	CHIP RES.	330	1/16W	5%	RMC1/16 331JATP	J24185331		1-	B	g5
R 4078	CHIP RES.	22k	1/16W	5%	RMC1/16 223JATP	J24185223		1-	A	B4
R 4079	CHIP RES.	0	1/16W	5%	RMC1/16 000JATP	J24185000		1-	B	f1
R 4080	CHIP RES.	4.7k	1/16W	5%	RMC1/16 472JATP	J24185472		1-	A	C4
R 4081	CHIP RES.	1k	1/16W	5%	RMC1/16 102JATP	J24185102		1-	A	C3
R 4082	CHIP RES.	1k	1/16W	5%	RMC1/16 102JATP	J24185102		1-	A	C3
R 4083	CHIP RES.	1k	1/16W	5%	RMC1/16 102JATP	J24185102		1-	A	C3
R 4084	CHIP RES.	330	1/16W	5%	RMC1/16 331JATP	J24185331		1-	B	d6
R 4085	CHIP RES.	1k	1/16W	5%	RMC1/16 102JATP	J24185102		1-	A	C3
R 4086	CHIP RES.	330	1/16W	5%	RMC1/16 331JATP	J24185331		1-	B	d6
R 4087	CHIP RES.	330	1/16W	5%	RMC1/16 331JATP	J24185331		1-	B	d6
R 4088	CHIP RES.	10k	1/16W	5%	RMC1/16 103JATP	J24185103		1-	B	f4
R 4089	CHIP RES.	1M	1/16W	5%	RMC1/16 105JATP	J24185105		1-	B	f4
R 4090	CHIP RES.	330	1/16W	5%	RMC1/16 331JATP	J24185331		1-	A	C4
R 4091	CHIP RES.	330	1/16W	5%	RMC1/16 331JATP	J24185331		1-	A	C4
R 4092	CHIP RES.	1k	1/16W	5%	RMC1/16 102JATP	J24185102		1-	B	e1
R 4093	CHIP RES.	0	1/16W	5%	RMC1/16 000JATP	J24185000		1-	B	e1
R 4094	CHIP RES.	0	1/16W	5%	RMC1/16 000JATP	J24185000		1-	B	e1
R 4095	CHIP RES.	10k	1/16W	5%	RMC1/16 103JATP	J24185103		1-	A	D5
R 4096	CHIP RES.	10k	1/16W	5%	RMC1/16 103JATP	J24185103		1-	A	D5
R 4097	CHIP RES.	10k	1/16W	5%	RMC1/16 103JATP	J24185103		1-	A	C5
R 4098	CHIP RES.	10k	1/16W	5%	RMC1/16 103JATP	J24185103		1-	A	D4
R 4099	CHIP RES.	10k	1/16W	5%	RMC1/16 103JATP	J24185103		1-	A	C5
R 4100	CHIP RES.	47k	1/16W	5%	RMC1/16 473JATP	J24185473		1-	B	f3
R 4101	CHIP RES.	4.7k	1/16W	5%	RMC1/16 472JATP	J24185472		1-	A	D2
R 4102	CHIP RES.	10k	1/16W	5%	RMC1/16 103JATP	J24185103		1-	A	E5
R 4103	CHIP RES.	470k	1/16W	1%	RMC1/16 474FTP	J24183474		6-	B	d2
R 4104	CHIP RES.	470k	1/16W	1%	RMC1/16 474FTP	J24183474		6-	B	d3
R 4105	CHIP RES.	100k	1/16W	5%	RMC1/16 104JATP	J24185104		1-	B	e2
R 4107	CHIP RES.	0	1/16W	5%	RMC1/16 000JATP	J24185000		1-	A	E5

REF.	DESCRIPTION	VALUE	V/W	TOL.	MFR'S DESIG	VXSTD P/N	VERS.	LOT.	SIDE	LAYADR
R 4108	CHIP RES.	100k	1/16W	5%	RMC1/16 104JATP	J24185104		1-	B	e2
R 4109	CHIP RES.	10k	1/16W	5%	RMC1/16 103JATP	J24185103		1-	A	E5
R 4110	CHIP RES.	47k	1/16W	5%	RMC1/16 473JATP	J24185473		1-	A	E5
R 4112	CHIP RES.	10k	1/16W	5%	RMC1/16 103JATP	J24185103		6-	A	E3
R 4113	CHIP RES.	10k	1/16W	5%	RMC1/16 103JATP	J24185103		1-	B	c4
R 4115	CHIP RES.	0	1/16W	5%	RMC1/16 000JATP	J24185000		1-5	A	F4
R 4116	CHIP RES.	47k	1/16W	5%	RMC1/16 473JATP	J24185473		1-	A	F4
R 4117	CHIP RES.	470k	1/16W	1%	RMC1/16 474FTP	J24183474		6-	B	d2
R 4118	CHIP RES.	470k	1/16W	1%	RMC1/16 474FTP	J24183474		6-	B	d2
R 4119	CHIP RES.	4.7k	1/16W	5%	RMC1/16 472JATP	J24185472		1-	B	e2
R 4120	CHIP RES.	12k	1/16W	5%	RMC1/16 123JATP	J24185123		1-	A	F5
R 4121	CHIP RES.	470k	1/16W	1%	RMC1/16 474FTP	J24183474		6-	B	e2
R 4122	CHIP RES.	2.2M	1/16W	5%	RMC1/16 225JATP	J24185225		1-	B	c5
R 4123	CHIP RES.	10k	1/16W	5%	RMC1/16 103JATP	J24185103		1-	A	D2
R 4124	CHIP RES.	220k	1/16W	5%	RMC1/16 224JATP	J24185224		1-	B	e2
R 4125	CHIP RES.	10k	1/16W	5%	RMC1/16 103JATP	J24185103		1-	A	D4
R 4126	CHIP RES.	470k	1/16W	1%	RMC1/16 474FTP	J24183474		6-	B	e2
R 4127	CHIP RES.	330	1/16W	5%	RMC1/16 331JATP	J24185331		1-	B	g5
R 4128	CHIP RES.	47k	1/16W	5%	RMC1/16 473JATP	J24185473		1-	B	d4
R 4129	CHIP RES.	100k	1/16W	5%	RMC1/16 104JATP	J24185104		1-	A	F4
R 4130	CHIP RES.	330k	1/16W	5%	RMC1/16 334JATP	J24185334		1-	B	e4
R 4131	CHIP RES.	100k	1/16W	5%	RMC1/16 104JATP	J24185104		1-	B	e2
R 4132	CHIP RES.	100k	1/16W	5%	RMC1/16 104JATP	J24185104		1-	B	e1
R 4133	CHIP RES.	6.8k	1/16W	5%	RMC1/16 682JATP	J24185682		1-	A	D2
R 4134	CHIP RES.	150k	1/16W	5%	RMC1/16 154JATP	J24185154		1-	B	e4
R 4135	CHIP RES.	150k	1/16W	5%	RMC1/16 154JATP	J24185154		1-	A	F4
R 4136	CHIP RES.	100k	1/16W	5%	RMC1/16 104JATP	J24185104		1-	B	e2
R 4137	CHIP RES.	10k	1/16W	5%	RMC1/16 103JATP	J24185103		1-	B	e4
R 4138	CHIP RES.	100k	1/16W	5%	RMC1/16 104JATP	J24185104		1-	B	e1
R 4139	CHIP RES.	120k	1/16W	1%	RMC1/16 124FTP	J24183124		6-	B	e2
R 4140	CHIP RES.	100k	1/16W	5%	RMC1/16 104JATP	J24185104		1-	B	e4
R 4141	CHIP RES.	150k	1/16W	5%	RMC1/16 154JATP	J24185154		1-	B	e4
R 4142	CHIP RES.	100k	1/16W	5%	RMC1/16 104JATP	J24185104		1-	A	E2
R 4143	CHIP RES.	100k	1/16W	5%	RMC1/16 104JATP	J24185104		1-	B	d4
R 4144	CHIP RES.	330	1/16W	5%	RMC1/16 331JATP	J24185331		1-	B	c6
R 4145	CHIP RES.	4.7k	1/16W	5%	RMC1/16 472JATP	J24185472		1-	A	F4
R 4145	CHIP RES.	3.3k	1/16W	5%	RMC1/16 332JATP	J24185332		6-	A	F4
R 4147	CHIP RES.	0	1/16W	5%	RMC1/16 000JATP	J24185000		1-	A	C5
R 4148	CHIP RES.	10k	1/16W	5%	RMC1/16 103JATP	J24185103		1-	B	c6
R 4149	CHIP RES.	10k	1/16W	5%	RMC1/16 103JATP	J24185103		1-	B	c6
R 4150	CHIP RES.	100k	1/16W	5%	RMC1/16 104JATP	J24185104		1-	B	e2
R 4151	CHIP RES.	470k	1/16W	5%	RMC1/16 474JATP	J24185474		1-	B	e2
R 4152	CHIP RES.	10k	1/16W	5%	RMC1/16 103JATP	J24185103		1-	A	C5
R 4153	CHIP RES.	330	1/16W	5%	RMC1/16 331JATP	J24185331		1-	B	g5
R 4154	CHIP RES.	330	1/16W	5%	RMC1/16 331JATP	J24185331		1-	B	f5
R 4155	CHIP RES.	100k	1/16W	5%	RMC1/16 104JATP	J24185104		1-6	B	e2
R 4155	CHIP RES.	56k	1/16W	5%	RMC1/16 563JATP	J24185563	VERSION A	7-	B	e2
R 4155	CHIP RES.	68k	1/16W	5%	RMC1/16 683JATP	J24185683	VERSION A	19-	B	e2
R 4155	CHIP RES.	100k	1/16W	5%	RMC1/16 104JATP	J24185104	VERSION C	7-	B	e2
R 4155	CHIP RES.	68k	1/16W	5%	RMC1/16 683JATP	J24185683	VERSION C	58-	B	e2
R 4156	CHIP RES.	10k	1/16W	5%	RMC1/16 103JATP	J24185103		1-	A	C5
R 4157	CHIP RES.	100k	1/16W	5%	RMC1/16 104JATP	J24185104		1-	B	d2
R 4158	CHIP RES.	10k	1/16W	5%	RMC1/16 103JATP	J24185103		1-	A	E1
R 4159	CHIP RES.	47k	1/16W	5%	RMC1/16 473JATP	J24185473		1-	A	D3
R 4160	CHIP RES.	82k	1/16W	5%	RMC1/16 823JATP	J24185823		1-	A	E2
R 4161	CHIP RES.	10k	1/16W	5%	RMC1/16 103JATP	J24185103		1-	B	e2
R 4162	CHIP RES.	10k	1/16W	5%	RMC1/16 103JATP	J24185103		1-	A	F3
R 4163	CHIP RES.	10k	1/16W	5%	RMC1/16 103JATP	J24185103		1-	A	F4
R 4164	CHIP RES.	6.8k	1/16W	5%	RMC1/16 682JATP	J24185682		1-	B	e2
R 4165	CHIP RES.	560	1/16W	5%	RMC1/16 561JATP	J24185561		1-	B	c6
R 4166	CHIP RES.	150k	1/16W	5%	RMC1/16 154JATP	J24185154		1-	B	e2
R 4167	CHIP RES.	4.7k	1/16W	5%	RMC1/16 472JATP	J24185472		1-	A	F4
R 4168	CHIP RES.	100	1/16W	5%	RMC1/16 101JATP	J24185101		1-	A	F3
R 4169	CHIP RES.	56k	1/16W	5%	RMC1/16 563JATP	J24185563		1-	A	G5
R 4170	CHIP RES.	100k	1/16W	5%	RMC1/16 104JATP	J24185104		1-	B	d2

CNTL Unit

REF.	DESCRIPTION	VALUE	V/W	TOL.	MFR'S DESIG	VXSTD P/N	VERS.	LOT.	SIDE	LAYADR
R 4171	CHIP RES.	1k	1/16W	5%	RMC1/16 102JATP	J24185102		1-	A	D3
R 4172	CHIP RES.	2.2k	1/16W	5%	RMC1/16 222JATP	J24185222		1-	A	F3
R 4173	CHIP RES.	100k	1/16W	5%	RMC1/16 104JATP	J24185104		1-	B	d2
R 4174	CHIP RES.	560k	1/16W	5%	RMC1/16 564JATP	J24185564		1-	B	b5
R 4175	CHIP RES.	47k	1/16W	5%	RMC1/16 473JATP	J24185473		1-	B	d2
R 4176	CHIP RES.	47k	1/16W	5%	RMC1/16 473JATP	J24185473		1-	B	d2
R 4177	CHIP RES.	47k	1/16W	5%	RMC1/16 473JATP	J24185473		1-	A	F3
R 4178	CHIP RES.	47k	1/16W	5%	RMC1/16 473JATP	J24185473		1-	A	F3
R 4179	CHIP RES.	47k	1/16W	5%	RMC1/16 473JATP	J24185473		1-	A	F3
R 4180	CHIP RES.	10k	1/16W	5%	RMC1/16 103JATP	J24185103		1-	A	F2
R 4181	CHIP RES.	3.3k	1/16W	5%	RMC1/16 332JATP	J24185332		1-	A	G5
R 4182	CHIP RES.	2.7k	1/16W	5%	RMC1/16 272JATP	J24185272		1-	A	G5
R 4183	CHIP RES.	47k	1/16W	5%	RMC1/16 473JATP	J24185473		1-	B	d2
R 4184	CHIP RES.	47k	1/16W	5%	RMC1/16 473JATP	J24185473		1-	B	d2
R 4185	CHIP RES.	47k	1/16W	5%	RMC1/16 473JATP	J24185473		1-	B	d2
R 4186	CHIP RES.	27k	1/16W	5%	RMC1/16 273JATP	J24185273		1-	A	G5
R 4187	CHIP RES.	10k	1/16W	5%	RMC1/16 103JATP	J24185103		1-	A	F4
R 4188	CHIP RES.	47k	1/16W	5%	RMC1/16 473JATP	J24185473		1-	B	d3
R 4189	CHIP RES.	47k	1/16W	5%	RMC1/16 473JATP	J24185473		1-	B	d3
R 4190	CHIP RES.	100k	1/16W	5%	RMC1/16 104JATP	J24185104		1-	A	F3
R 4191	CHIP RES.	47k	1/16W	5%	RMC1/16 473JATP	J24185473		1-	B	d3
R 4192	CHIP RES.	39k	1/16W	5%	RMC1/16 393JATP	J24185393		1-	B	c3
R 4193	CHIP RES.	4.7k	1/16W	5%	RMC1/16 472JATP	J24185472		1-	A	F2
R 4194	CHIP RES.	220k	1/16W	5%	RMC1/16 224JATP	J24185224		1-	B	d3
R 4195	CHIP RES.	1.8k	1/16W	5%	RMC1/16 182JATP	J24185182		1-	A	F2
R 4196	CHIP RES.	0	1/16W	5%	RMC1/16 000JATP	J24185000		1-	B	d3
R 4197	CHIP RES.	47k	1/16W	5%	RMC1/16 473JATP	J24185473		1-	A	G5
R 4198	CHIP RES.	4.7k	1/16W	5%	RMC1/16 472JATP	J24185472		1-	A	F2
R 4199	CHIP RES.	270k	1/16W	5%	RMC1/16 274JATP	J24185274		1-	B	c3
R 4200	CHIP RES.	330k	1/16W	5%	RMC1/16 334JATP	J24185334		1-	B	c3
R 4202	CHIP RES.	82k	1/16W	5%	RMC1/16 823JATP	J24185823		1-	B	b5
R 4203	CHIP RES.	3.3M	1/16W	5%	RMC1/16 335JATP	J24185335		1-	B	c3
R 4204	CHIP RES.	1.8k	1/16W	5%	RMC1/16 182JATP	J24185182		1-	A	F2
R 4205	CHIP RES.	15k	1/16W	5%	RMC1/16 153JATP	J24185153		1-	A	F3
R 4206	CHIP RES.	10k	1/16W	5%	RMC1/16 103JATP	J24185103		1-	A	F3
R 4207	CHIP RES.	10k	1/16W	5%	RMC1/16 103JATP	J24185103		1-	A	F3
R 4209	CHIP RES.	10k	1/16W	5%	RMC1/16 103JATP	J24185103		1-	A	F2
R 4210	CHIP RES.	39k	1/16W	5%	RMC1/16 393JATP	J24185393		1-	B	c3
R 4211	CHIP RES.	1k	1/16W	5%	RMC1/16 102JATP	J24185102		1-	B	c2
R 4212	CHIP RES.	6.8k	1/16W	5%	RMC1/16 682JATP	J24185682		1-	A	G4
R 4214	CHIP RES.	220k	1/16W	5%	RMC1/16 224JATP	J24185224		1-	B	c3
R 4215	CHIP RES.	0	1/16W	5%	RMC1/16 000JATP	J24185000		1-	B	c4
R 4216	CHIP RES.	47k	1/16W	5%	RMC1/16 473JATP	J24185473		1-	A	F2
R 4216	CHIP RES.	150k	1/16W	5%	RMC1/16 154JATP	J24185154		3-	A	F2
R 4217	CHIP RES.	15k	1/16W	5%	RMC1/16 153JATP	J24185153		1-	A	F2
R 4218	CHIP RES.	10k	1/16W	5%	RMC1/16 103JATP	J24185103		1-	A	F4
R 4219	CHIP RES.	15k	1/16W	5%	RMC1/16 153JATP	J24185153		1-	A	F2
R 4220	CHIP RES.	4.7k	1/16W	5%	RMC1/16 472JATP	J24185472		1-	B	c2
R 4221	CHIP RES.	10k	1/16W	5%	RMC1/16 103JATP	J24185103		1-	A	F3
R 4222	CHIP RES.	1k	1/16W	5%	RMC1/16 102JATP	J24185102		1-	A	F1
R 4223	CHIP RES.	8.2k	1/16W	5%	RMC1/16 822JATP	J24185822		1-	A	F3
R 4224	CHIP RES.	1k	1/16W	5%	RMC1/16 102JATP	J24185102		1-	A	F2
R 4225	CHIP RES.	1k	1/16W	5%	RMC1/16 102JATP	J24185102		1-	B	c1
R 4226	CHIP RES.	82k	1/16W	5%	RMC1/16 823JATP	J24185823		1-	B	c2
R 4227	CHIP RES.	560k	1/16W	5%	RMC1/16 564JATP	J24185564		1-	B	c3
R 4228	CHIP RES.	56k	1/16W	5%	RMC1/16 563JATP	J24185563		1-	A	G4
R 4229	CHIP RES.	12k	1/16W	5%	RMC1/16 123JATP	J24185123		1-	A	G5
R 4230	CHIP RES.	68k	1/16W	5%	RMC1/16 683JATP	J24185683		1-	B	c3
R 4231	CHIP RES.	10k	1/16W	5%	RMC1/16 103JATP	J24185103		1-	A	F1
R 4232	CHIP RES.	68k	1/16W	5%	RMC1/16 683JATP	J24185683		1-	A	F1
R 4233	CHIP RES.	22k	1/16W	5%	RMC1/16 223JATP	J24185223		1-	A	F1
R 4234	CHIP RES.	68k	1/16W	5%	RMC1/16 683JATP	J24185683		1-	B	c1
R 4235	CHIP RES.	22k	1/16W	5%	RMC1/16 223JATP	J24185223		1-	B	c3
R 4235	CHIP RES.	0	1/16W	5%	RMC1/16 000JATP	J24185000		5-	B	c3
R 4236	CHIP RES.	100k	1/16W	5%	RMC1/16 104JATP	J24185104		1-	B	b5

REF.	DESCRIPTION	VALUE	V/W	TOL.	MFR'S DESIG	VXSTD P/N	VERS.	LOT.	SIDE	LAYADR
R 4237	CHIP RES.	470	1/16W	5%	RMC1/16 471JATP	J24185471		1-	A	H1
R 4238	CHIP RES.	560	1/16W	5%	RMC1/16 561JATP	J24185561		1-	B	c1
R 4239	CHIP RES.	33k	1/16W	5%	RMC1/16 333JATP	J24185333		1-	A	G2
R 4240	CHIP RES.	0	1/16W	5%	RMC1/16 000JATP	J24185000		1-	B	a3
R 4241	CHIP RES.	4.7k	1/16W	5%	RMC1/16 472JATP	J24185472		1-	A	F2
R 4242	CHIP RES.	560k	1/16W	5%	RMC1/16 564JATP	J24185564		1-	B	c3
R 4243	CHIP RES.	2.7k	1/16W	5%	RMC1/16 272JATP	J24185272		1-	A	H4
R 4244	CHIP RES.	270k	1/16W	5%	RMC1/16 274JATP	J24185274		1-	B	a4
R 4245	CHIP RES.	1M	1/16W	5%	RMC1/16 105JATP	J24185105		1-	A	H3
R 4246	CHIP RES.	22k	1/16W	5%	RMC1/16 223JATP	J24185223		1-	A	G4
R 4247	CHIP RES.	10k	1/16W	5%	RMC1/16 103JATP	J24185103		1-	B	c2
R 4248	CHIP RES.	100k	1/16W	5%	RMC1/16 104JATP	J24185104		1-	A	G4
R 4249	CHIP RES.	68k	1/16W	5%	RMC1/16 683JATP	J24185683		1-	B	c1
R 4250	CHIP RES.	8.2k	1/16W	5%	RMC1/16 822JATP	J24185822		1-	B	c2
R 4251	CHIP RES.	270k	1/16W	5%	RMC1/16 274JATP	J24185274		1-	B	b4
R 4252	CHIP RES.	560k	1/16W	5%	RMC1/16 564JATP	J24185564		1-	B	c3
R 4253	CHIP RES.	100k	1/16W	5%	RMC1/16 104JATP	J24185104		1-	B	b4
R 4254	CHIP RES.	39k	1/16W	5%	RMC1/16 393JATP	J24185393		1-	A	G3
R 4254	CHIP RES.	56k	1/16W	5%	RMC1/16 563JATP	J24185563		5-	A	G3
R 4255	CHIP RES.	82k	1/16W	5%	RMC1/16 823JATP	J24185823		1-	B	c2
R 4256	CHIP RES.	47k	1/16W	5%	RMC1/16 473JATP	J24185473		1-	B	a3
R 4257	CHIP RES.	18k	1/16W	5%	RMC1/16 183JATP	J24185183		1-	B	b3
R 4258	CHIP RES.	56k	1/16W	5%	RMC1/16 563JATP	J24185563		1-	A	G5
R 4259	CHIP RES.	8.2k	1/16W	5%	RMC1/16 822JATP	J24185822		1-	A	F1
R 4260	CHIP RES.	10k	1/16W	5%	RMC1/16 103JATP	J24185103		1-	A	G4
R 4261	CHIP RES.	10k	1/16W	5%	RMC1/16 103JATP	J24185103		1-	A	F1
R 4262	CHIP RES.	1.2k	1/16W	5%	RMC1/16 122JATP	J24185122		1-	B	a1
R 4263	CHIP RES.	12k	1/16W	5%	RMC1/16 123JATP	J24185123		1-	B	c3
R 4264	CHIP RES.	47k	1/16W	5%	RMC1/16 473JATP	J24185473		1-	B	b4
R 4265	CHIP RES.	8.2k	1/16W	5%	RMC1/16 822JATP	J24185822		1-	A	G4
R 4266	CHIP RES.	100k	1/16W	5%	RMC1/16 104JATP	J24185104		1-	A	F2
R 4267	CHIP RES.	2.7	1/10W	5%	RMC1/10T 2R7J	J24205279		1-	A	H4
R 4268	CHIP RES.	100k	1/16W	5%	RMC1/16 104JATP	J24185104		1-	B	c1
R 4269	CHIP RES.	3.3k	1/16W	5%	RMC1/16 332JATP	J24185332		1-	B	a3
R 4270	CHIP RES.	18k	1/16W	5%	RMC1/16 183JATP	J24185183		1-	B	b1
R 4271	CHIP RES.	220k	1/16W	5%	RMC1/16 224JATP	J24185224		1-	B	b5
R 4272	CHIP RES.	100k	1/16W	5%	RMC1/16 104JATP	J24185104		1-	B	b2
R 4273	CHIP RES.	47k	1/16W	5%	RMC1/16 473JATP	J24185473		1-	B	c3
R 4274	CHIP RES.	100k	1/16W	5%	RMC1/16 104JATP	J24185104		1-	B	b4
R 4275	CHIP RES.	560	1/16W	5%	RMC1/16 561JATP	J24185561		1-	B	b1
R 4276	CHIP RES.	270	1/10W	5%	RMC1/10T 271J	J24205271		1-	B	a4
R 4277	CHIP RES.	33k	1/16W	5%	RMC1/16 333JATP	J24185333		1-	B	b4
R 4278	CHIP RES.	100k	1/16W	5%	RMC1/16 104JATP	J24185104		1-	B	c2
R 4279	CHIP RES.	100k	1/16W	5%	RMC1/16 104JATP	J24185104		1-	A	G4
R 4280	CHIP RES.	100k	1/16W	5%	RMC1/16 104JATP	J24185104		1-	B	c2
R 4281	CHIP RES.	3.9k	1/16W	5%	RMC1/16 392JATP	J24185392		1-	A	G4
R 4282	CHIP RES.	100k	1/16W	5%	RMC1/16 104JATP	J24185104		1-	A	G4
R 4283	CHIP RES.	560	1/16W	5%	RMC1/16 561JATP	J24185561		1-	B	b2
R 4284	CHIP RES.	1	1/10W	5%	RMC1/10T 1R0J	J24205010		1-	B	a4
R 4285	CHIP RES.	4.7k	1/16W	5%	RMC1/16 472JATP	J24185472		1-	A	G4
R 4286	CHIP RES.	4.7	1W	5%	RMC1 4R7JTE	J24305479		1-	B	a5
R 4287	CHIP RES.	10k	1/16W	5%	RMC1/16 103JATP	J24185103		6-	A	E3
R 4288	CHIP RES.	4.7	1W	5%	RMC1 4R7JTE	J24305479		1-	B	b5
R 4289	CHIP RES.	100k	1/16W	5%	RMC1/16 104JATP	J24185104		1-	B	c2
R 4290	CHIP RES.	100k	1/16W	5%	RMC1/16 104JATP	J24185104		1-	B	c2
R 4291	CHIP RES.	4.7k	1/16W	5%	RMC1/16 472JATP	J24185472		1-5		
R 4292	CARBON FILM RES.	10k	1/6W	5%	RD16UJ103 10K	J02225103		1-	B	f3
R 4292	CHIP RES.	10k	1/16W	5%	RMC1/16 103JATP	J24185103		6-	B	f3
R 4293	CARBON FILM RES.	10k	1/6W	5%	RD16UJ103 10K	J02225103		1-	B	f3
R 4293	CHIP RES.	10k	1/16W	5%	RMC1/16 103JATP	J24185103		6-	B	f3
R 4294	CARBON FILM RES.	4.7k	1/6W	5%	RD16PJ472 4.7K	J01225472		1-	A	F1
R 4294	CHIP RES.	4.7k	1/16W	5%	RMC1/16 472JATP	J24185472		6-	A	F1
R 4295	CARBON FILM RES.	560	1/6W	5%	RD16PJ561 560	J01225561		2-	B	h2
R 4295	CHIP RES.	560	1/16W	5%	RMC1/16 561JATP	J24185561		6-	B	h2
R 4296	CHIP RES.	1k	1/16W	5%	RMC1/16 102JATP	J24185102		2-	A	B4

CNTL Unit

REF.	DESCRIPTION	VALUE	V/W	TOL.	MFR'S DESIG	VXSTD P/N	VERS.	LOT.	SIDE	LAYADR
R 4297	CHIP RES.	1k	1/16W	5%	RMC1/16 102JATP	J24185102		2-	A	B5
R 4298	CHIP RES.	4.7k	1/16W	5%	RMC1/16 472JATP	J24185472		2-	A	C5
R 4299	CARBON FILM RES.	560	1/6W	5%	RD16PJ561 560	J01225561		2-	B	h2
R 4299	CHIP RES.	560	1/16W	5%	RMC1/16 561JATP	J24185561		6-	B	h2
R 4300	CHIP RES.	6.8k	1/16W	5%	RMC1/16 682JATP	J24185682		6-	A	E2
R 4301	CHIP RES.	10k	1/16W	5%	RMC1/16 103JATP	J24185103		6-	B	e2
R 4302	CHIP RES.	120k	1/16W	5%	RMC1/16 124JATP	J24185124		6-	A	E3
R 4303	CHIP RES.	120k	1/16W	5%	RMC1/16 124JATP	J24185124		6-	A	E3
R 4304	CHIP RES.	120k	1/16W	5%	RMC1/16 124JATP	J24185124		6-	A	E3
R 4305	CHIP RES.	120k	1/16W	5%	RMC1/16 124JATP	J24185124		6-	B	d3
R 4306	CHIP RES.	120k	1/16W	5%	RMC1/16 124JATP	J24185124		6-	B	d3
R 4307	CHIP RES.	2.2k	1/16W	5%	RMC1/16 222JATP	J24185222		6-	B	c3
R 4308	CHIP RES.	0	1/16W	5%	RMC1/16 000JATP	J24185000		6-	B	d3
R 4309	CHIP RES.	33k	1/16W	5%	RMC1/16 333JATP	J24185333		6-	B	d3
R 4310	CHIP RES.	1.5M	1/16W	5%	RMC1/16 155JATP	J24185155		6-	B	d3
R 4311	CHIP RES.	220k	1/16W	5%	RMC1/16 224JATP	J24185224		6-	B	d3
R 4312	CHIP RES.	100k	1/16W	5%	RMC1/16 104JATP	J24185104		6-	A	F3
R 4313	CHIP RES.	10k	1/16W	5%	RMC1/16 103JATP	J24185103		6-	A	E4
R 4314	CHIP RES.	6.8k	1/16W	5%	RMC1/16 682JATP	J24185682		6-	A	F4
R 4315	CHIP RES.	4.7k	1/16W	5%	RMC1/16 472JATP	J24185472		6-	A	G4
R 4316	CHIP RES.	0	1/16W	5%	RMC1/16 000JATP	J24185000		6-	A	G5
R 4318	CHIP RES.	18k	1/16W	5%	RMC1/16 183JATP	J24185183		6-	B	d3
R 4319	CHIP RES.	1k	1/16W	5%	RMC1/16 102JATP	J24185102		6-	A	G1
R 4322	CHIP RES.	0	1/16W	5%	RMC1/16 000JATP	J24185000		6-	B	c5
R 4401	CHIP RES.	0	1/16W	5%	RMC1/16 000JATP	J24185000		3-		
R 4402	CHIP RES.	0	1/16W	5%	RMC1/16 000JATP	J24185000		3-		
R 4403	CHIP RES.	0	1/16W	5%	RMC1/16 000JATP	J24185000		3-		
R 4404	CHIP RES.	0	1/16W	5%	RMC1/16 000JATP	J24185000		3-		
R 4405	CHIP RES.	0	1/16W	5%	RMC1/16 000JATP	J24185000		3-		
R 4406	CHIP RES.	0	1/16W	5%	RMC1/16 000JATP	J24185000		3-		
R 4501	CHIP RES.	0	1/10W	5%	RMC1/10T 000J	J24205000		3-5		
S 4001	SLIDE SWITCH				SSSS21	N6090069		1-	A	G3
S 4002	SLIDE SWITCH				SSSS21	N6090069		1-	A	G1
T 4001	AF TRANS.				12T01	L2190049		1-	A	H2
T 4002	AF TRANS.				12T01	L2190049		1-	A	H3
VR4001	POT.	100k			EVN-5ESX50B15	J51811104		1-	A	D3
VR4002	POT.	10k			EVN-5ESX50B14	J51811103		1-	A	G3
VR4003	POT.	10k			EVN-5ESX50B14	J51811103		1-	A	G2
X 4001	XTAL HC-49/S3	16MHz			16.000MHZ	H0103174		1-	A	C4
X 4002	XTAL HC-49/4H	4.194304MHZ			4.194304MHZ	H0103081		1-	A	E5
	HEAT SINK				SP143K	S5000217		1-		

LPF Unit (Lot. 1~5)

Circuit Diagram

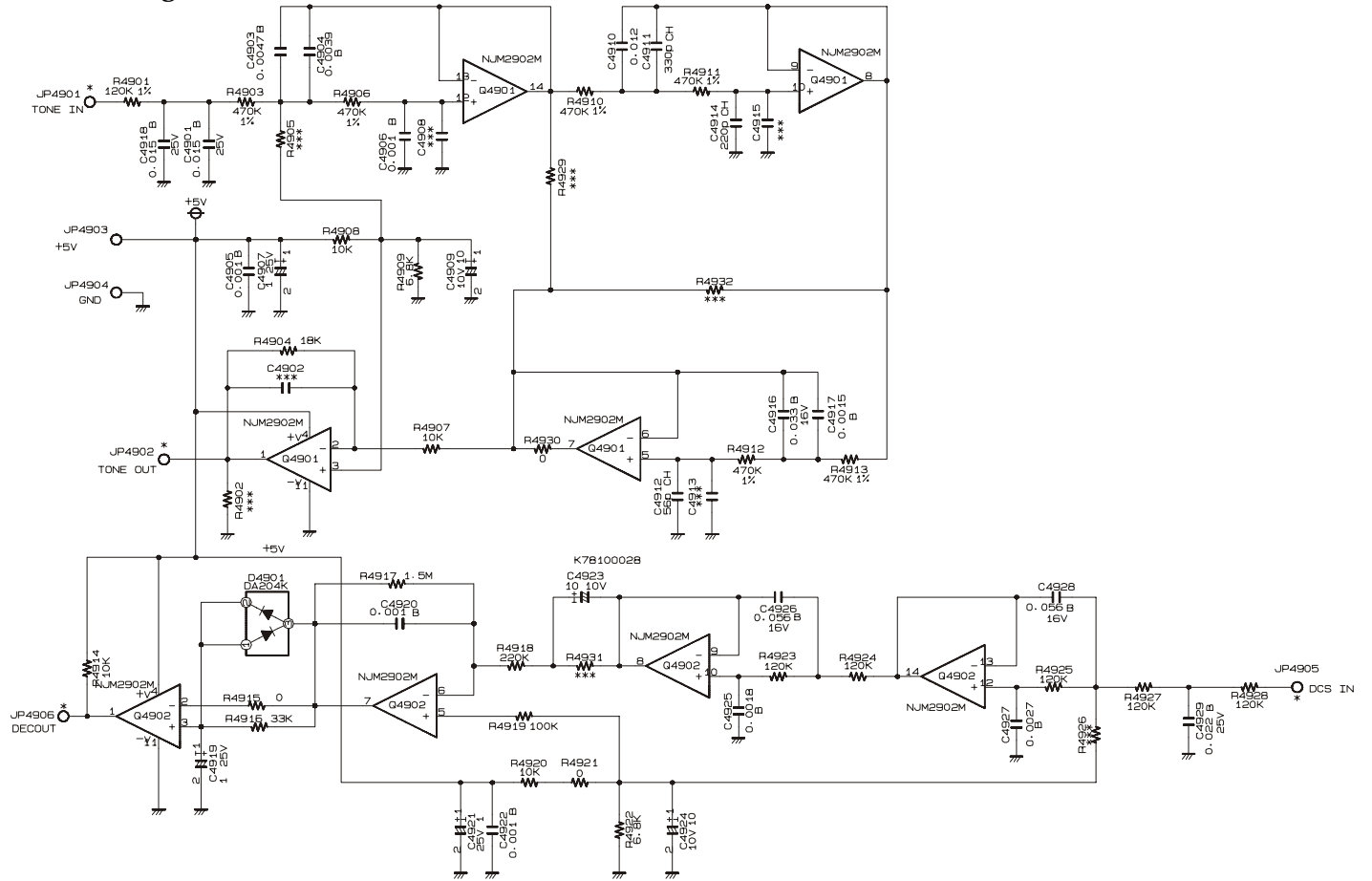

Parts Layout

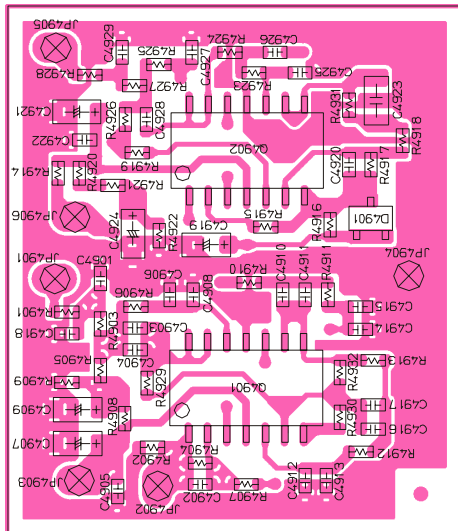

Side A

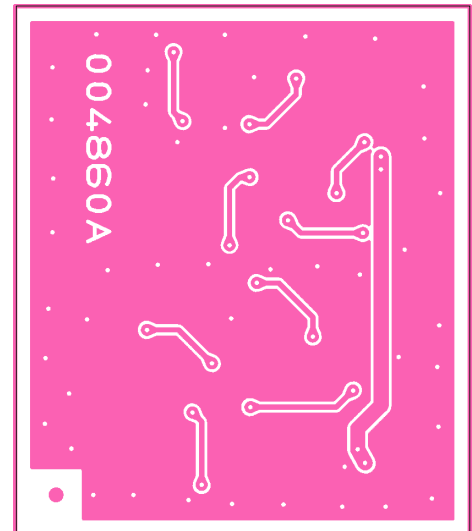

Side B

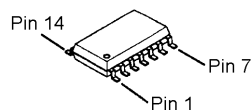

NJM2902M
(Q4901, 4902)

Cathode 1, Anode 2

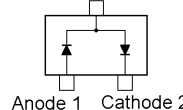

DA204K (K)
(D4901)

LPF Unit (Lot. 1~5)

Parts List

REF	DESCRIPTION	VALUE	V/W	TOL	MFR'S DESIG	VXSTD P/N	VERS	LOT	SIDE	LAY ADR
PCB with Components						CB1118001				
Printed Circuit Board						FR004860A				
C 4901	CHIP CAP.	0.015uF	25V	B	GRM39B153K25PT	K22144805		1-	A	A1
C 4903	CHIP CAP.	0.0047uF	50V	B	ECJ1VB1H472K	K22179622		1-	A	A1
C 4904	CHIP CAP.	0.0039uF	50V	B	GRM39B392K50PT	K22174830		1-	A	A1
C 4905	CHIP CAP.	0.001uF	50V	B	GRM39B102K50PT	K22174821		1-	A	A2
C 4906	CHIP CAP.	0.001uF	50V	B	GRM39B102K50PT	K22174821		1-	A	A1
C 4907	CHIP TA.CAP.	1uF	25V		TEMSVA1E105M-8R	K78140013		1-	A	A2
C 4909	CHIP TA.CAP.	10uF	10V		TEMSVA1A106M-8R	K78100028		1-	A	A2
C 4910	CHIP CAP.	0.012uF	50V	B	GRM39B123K50PT	K22174825		1-	A	A1
C 4911	CHIP CAP.	330pF	50V	CH	GRM39CH331J50PT	K22174253		1-	A	A1
C 4912	CHIP CAP.	56pF	50V	CH	GRM39CH560J50PT	K22174229		1-	A	A2
C 4914	CHIP CAP.	220pF	50V	CH	GRM39CH221J50PT	K22174243		1-	A	B1
C 4916	CHIP CAP.	0.033uF	16V	B	ECJ1VB1C333K	K22129515		1-	A	B2
C 4917	CHIP CAP.	0.0015uF	50V	B	GRM39B152K50PT	K22174827		1-	A	B2
C 4918	CHIP CAP.	0.015uF	25V	B	GRM39B153K25PT	K22144805		1-	A	A1
C 4919	CHIP TA.CAP.	1uF	25V		TEMSVA1E105M-8R	K78140013		1-	A	A1
C 4920	CHIP CAP.	0.001uF	50V	B	GRM39B102K50PT	K22174821		1-	A	B1
C 4921	CHIP TA.CAP.	1uF	25V		TEMSVA1E105M-8R	K78140013		1-	A	A1
C 4922	CHIP CAP.	0.001uF	50V	B	GRM39B102K50PT	K22174821		1-	A	A1
C 4923	CHIP TA.CAP.	10uF	10V		TEMSVA1A106M-8R	K78100028		1-	A	B1
C 4924	CHIP TA.CAP.	10uF	10V		TEMSVA1A106M-8R	K78100028		1-	A	A1
C 4925	CHIP CAP.	0.0018uF	50V	B	ECJ1VB1H182K	K22179617		1-	A	A1
C 4926	CHIP CAP.	0.056uF	16V	B	GRM39B563K16PT	K22124807		1-	A	A1
C 4927	CHIP CAP.	0.0027uF	50V	B	ECJ1VB1H272K	K22179619		1-	A	A1
C 4928	CHIP CAP.	0.056uF	16V	B	GRM39B563K16PT	K22124807		1-	A	A1
C 4929	CHIP CAP.	0.022uF	25V	B	GRM39B223K25PT	K22144807		1-	A	A1
D 4901	DIODE				DA204K T146	G2070388		1-	A	B1
Q 4901	IC				NJM2902M(Te1)	G1093092		1-	A	A2
Q 4902	IC				NJM2902M(Te1)	G1093092		1-	A	A1
R 4901	CHIP RES.	120k	1/16W	1%	RMC1/16 124FTP	J24183124		1-	A	A1
R 4903	CHIP RES.	470k	1/16W	1%	RMC1/16 474FTP	J24183474		1-	A	A1
R 4904	CHIP RES.	18k	1/16W	5%	RMC1/16 183JATP	J24185183		1-	A	A2
R 4906	CHIP RES.	470k	1/16W	1%	RMC1/16 474FTP	J24183474		1-	A	A1
R 4907	CHIP RES.	10k	1/16W	5%	RMC1/16 103JATP	J24185103		1-	A	A2
R 4908	CHIP RES.	10k	1/16W	5%	RMC1/16 103JATP	J24185103		1-	A	A2
R 4909	CHIP RES.	6.8k	1/16W	5%	RMC1/16 682JATP	J24185682		1-	A	A2
R 4910	CHIP RES.	470k	1/16W	1%	RMC1/16 474FTP	J24183474		1-	A	A1
R 4911	CHIP RES.	470k	1/16W	1%	RMC1/16 474FTP	J24183474		1-	A	B1
R 4912	CHIP RES.	470k	1/16W	1%	RMC1/16 474FTP	J24183474		1-	A	B2
R 4913	CHIP RES.	470k	1/16W	1%	RMC1/16 474FTP	J24183474		1-	A	B2
R 4914	CHIP RES.	10k	1/16W	5%	RMC1/16 103JATP	J24185103		1-	A	A1
R 4915	CHIP RES.	0	1/16W	5%	RMC1/16 000JATP	J24185000		1-	A	A1
R 4916	CHIP RES.	33k	1/16W	5%	RMC1/16 333JATP	J24185333		1-	A	B1
R 4917	CHIP RES.	1.5M	1/16W	5%	RMC1/16 155JATP	J24185155		1-	A	B1
R 4918	CHIP RES.	220k	1/16W	5%	RMC1/16 224JATP	J24185224		1-	A	B1
R 4919	CHIP RES.	100k	1/16W	5%	RMC1/16 104JATP	J24185104		1-	A	A1
R 4920	CHIP RES.	10k	1/16W	5%	RMC1/16 103JATP	J24185103		1-	A	A1
R 4921	CHIP RES.	0	1/16W	5%	RMC1/16 000JATP	J24185000		1-	A	A1
R 4922	CHIP RES.	6.8k	1/16W	5%	RMC1/16 682JATP	J24185682		1-	A	A1
R 4923	CHIP RES.	120k	1/16W	5%	RMC1/16 124JATP	J24185124		1-	A	A1
R 4924	CHIP RES.	120k	1/16W	5%	RMC1/16 124JATP	J24185124		1-	A	A1
R 4925	CHIP RES.	120k	1/16W	5%	RMC1/16 124JATP	J24185124		1-	A	A1
R 4927	CHIP RES.	120k	1/16W	5%	RMC1/16 124JATP	J24185124		1-	A	A1
R 4928	CHIP RES.	120k	1/16W	5%	RMC1/16 124JATP	J24185124		1-	A	A1
R 4930	CHIP RES.	0	1/16W	5%	RMC1/16 000JATP	J24185000		1-	A	B2

Circuit Diagram

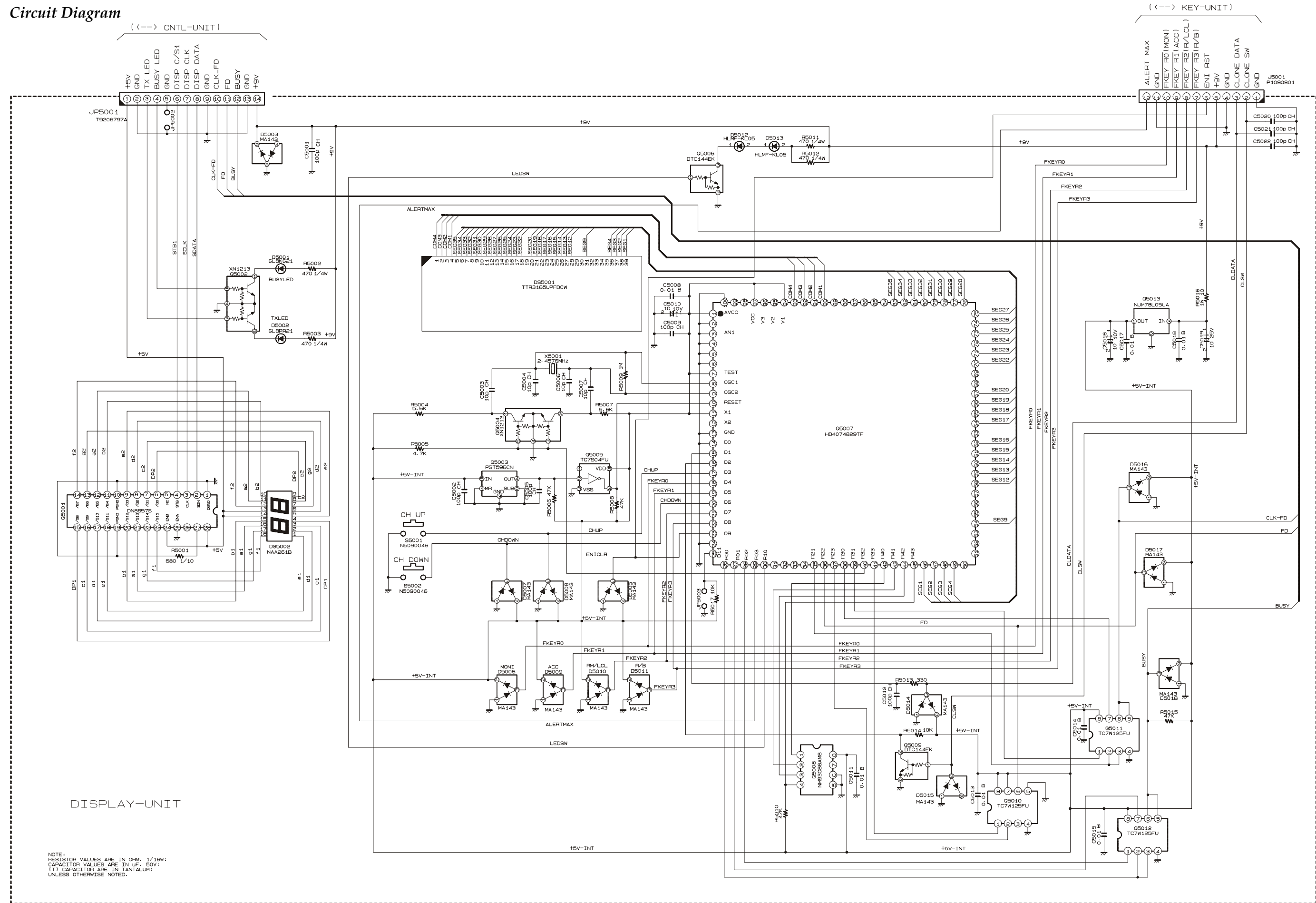

NOTE:
RESISTOR VALUES ARE IN OHM, 1/16W;
CAPACITOR VALUES ARE IN UF, 50V;
(T) CAPACITOR ARE IN TANTALUM;
UNLESS OTHERWISE NOTED.

Display Unit

Parts Layout

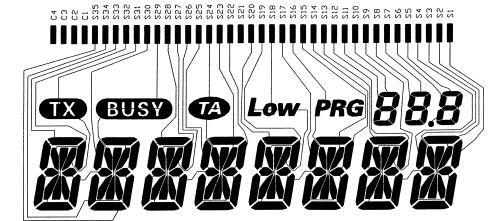
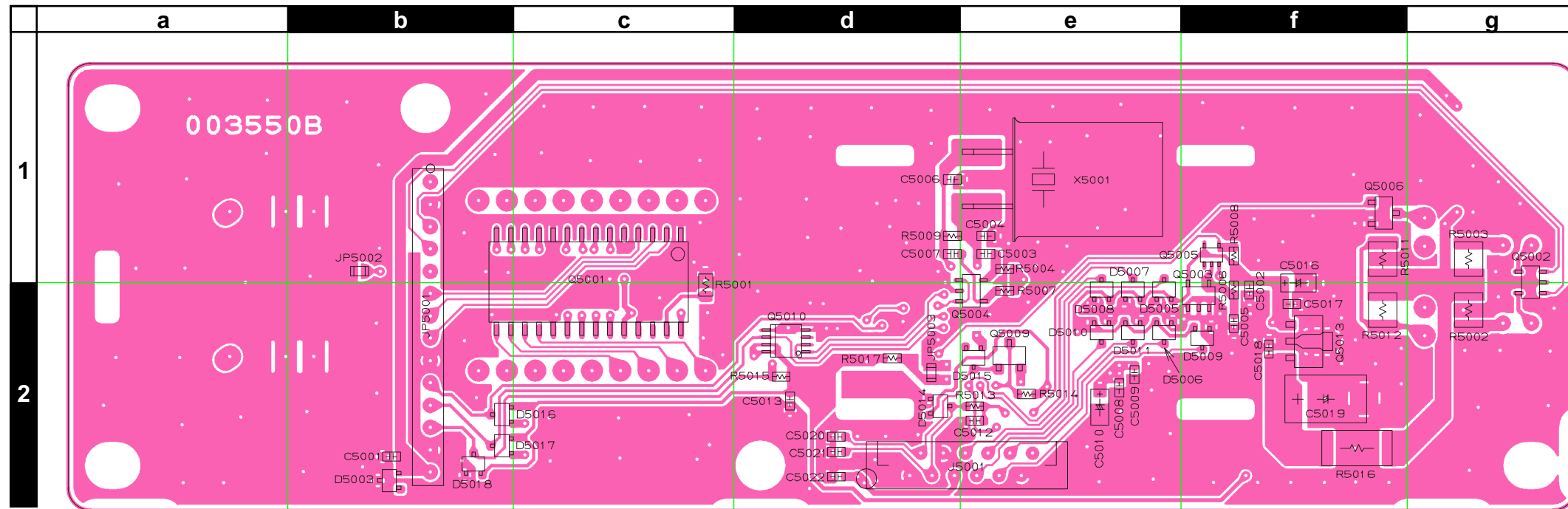
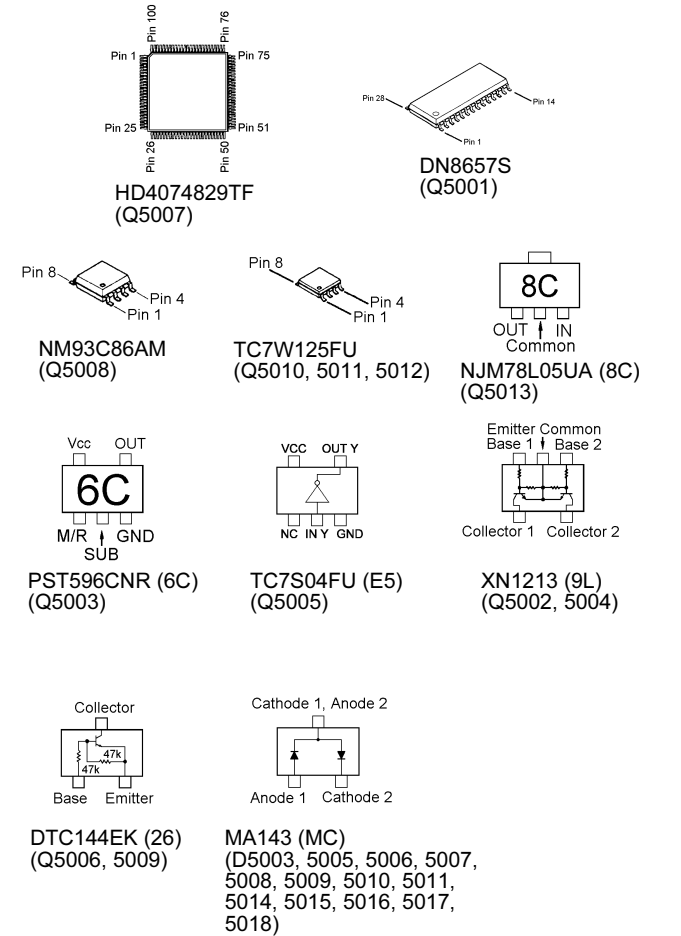
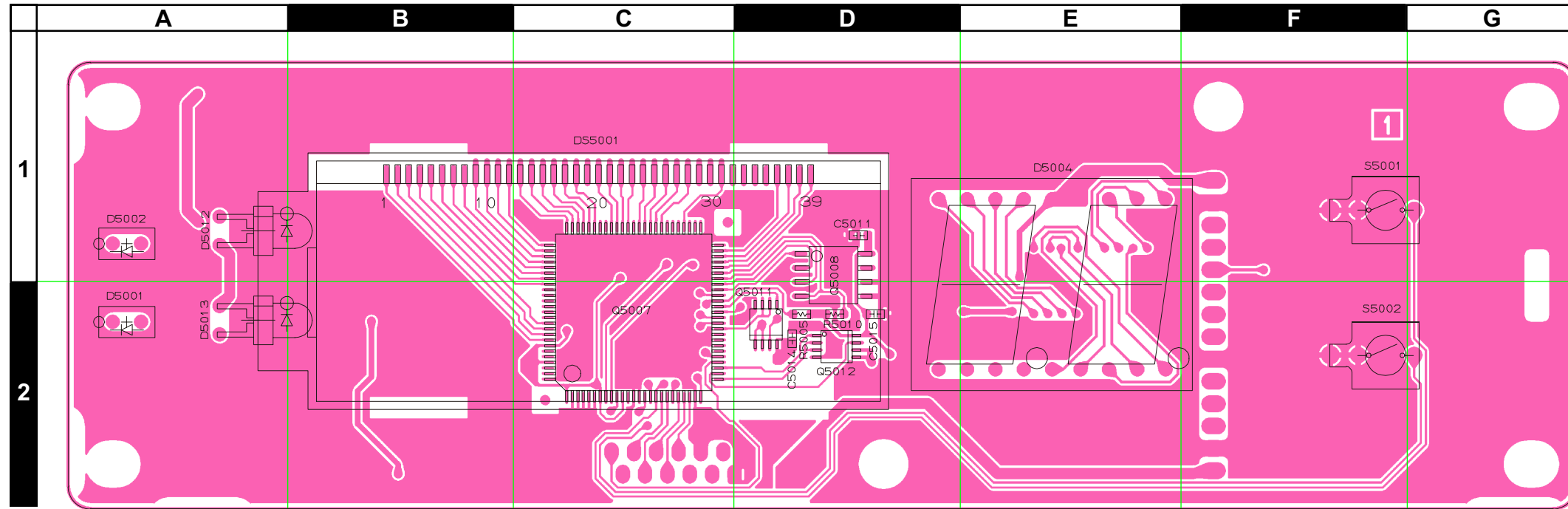

LCD Display Segmentation Diagram

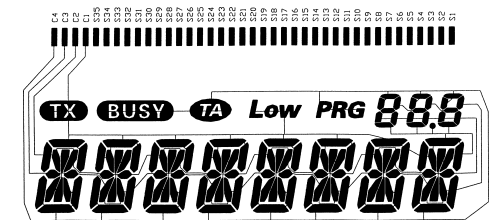

LCD Display Backplane Diagram

Display Unit

Parts List

REF.	DESCRIPTION	VALUE	V/W	TOL.	MFR'S DESIG	VXSTD P/N	VERS.	LOT.	SIDE	LAYADR
*** DISPLAY UNIT ***										
PCB with Components						CS1652001				
	Printed Circuit Board					FR003550B		1-		
C 5001	CHIP CAP.	100pF	50V	CH	GRM1882C1H101JA01D	K22174235		1-	B	b2
C 5002	CHIP CAP.	100pF	50V	CH	GRM1882C1H101JA01D	K22174235		1-	B	f2
C 5003	CHIP CAP.	10pF	50V	CH	GRM1882C1H100JA01D	K22174211		1-	B	e1
C 5004	CHIP CAP.	10pF	50V	CH	GRM1882C1H100JA01D	K22174211		1-	B	e1
C 5005	CHIP CAP.	100pF	50V	CH	GRM1882C1H101JA01D	K22174235		1-	B	f2
C 5006	CHIP CAP.	10pF	50V	CH	GRM1882C1H100JA01D	K22174211		1-	B	d1
C 5007	CHIP CAP.	10pF	50V	CH	GRM1882C1H100JA01D	K22174211		1-	B	d1
C 5008	CHIP CAP.	0.01uF	50V	B	GRM188B11H103KA01D	K22174823		1-	B	e2
C 5009	CHIP CAP.	100pF	50V	CH	GRM1882C1H101JA01D	K22174235		1-	B	e2
C 5010	CHIP TA.CAP.	10uF	10V		TEMSVA1A106M-8R	K78100028		1-	B	e2
C 5011	CHIP CAP.	0.01uF	50V	B	GRM188B11H103KA01D	K22174823		1-	A	D1
C 5012	CHIP CAP.	100pF	50V	CH	GRM1882C1H101JA01D	K22174235		1-	B	e2
C 5013	CHIP CAP.	0.01uF	50V	B	GRM188B11H103KA01D	K22174823		1-	B	d2
C 5014	CHIP CAP.	0.01uF	50V	B	GRM188B11H103KA01D	K22174823		1-	A	D2
C 5015	CHIP CAP.	0.01uF	50V	B	GRM188B11H103KA01D	K22174823		1-	A	D2
C 5016	CHIP TA.CAP.	10uF	10V		TEMSVA1A106M-8R	K78100028		1-	B	f1
C 5017	CHIP CAP.	0.01uF	50V	B	GRM188B11H103KA01D	K22174823		1-	B	f2
C 5018	CHIP CAP.	0.01uF	50V	B	GRM188B11H103KA01D	K22174823		1-	B	f2
C 5019	CHIP TA.CAP.	10uF	25V		TESVD1E106M12R	K78140018		1-	B	f2
C 5020	CHIP CAP.	100pF	50V	CH	GRM1882C1H101JA01D	K22174235		1-	B	d2
C 5021	CHIP CAP.	100pF	50V	CH	GRM1882C1H101JA01D	K22174235		1-	B	d2
C 5022	CHIP CAP.	100pF	50V	CH	GRM1882C1H101JA01D	K22174235		1-	B	d2
D 5001	LED				GL8KG21	G2090625		1-	A	A2
D 5002	LED				GL8PR21	G2090395		1-	A	A1
D 5003	DIODE				MA143-(TX)	G2070536		1-	B	b2
D 5005	DIODE				MA143-(TX)	G2070536		1-	B	e2
D 5006	DIODE				MA143-(TX)	G2070536		1-	B	e2
D 5007	DIODE				MA143-(TX)	G2070536		1-	B	e2
D 5008	DIODE				MA143-(TX)	G2070536		1-	B	e2
D 5009	DIODE				MA143-(TX)	G2070536		1-	B	f2
D 5010	DIODE				MA143-(TX)	G2070536		1-	B	e2
D 5011	DIODE				MA143-(TX)	G2070536		1-	B	e2
D 5012	LED				HLMF-KL05	G2090692		1-	A	A1
D 5013	LED				HLMF-KL05	G2090692		1-	A	A2
D 5014	DIODE				MA143-(TX)	G2070536		1-	B	d2
D 5015	DIODE				MA143-(TX)	G2070536		1-	B	e2
D 5016	DIODE				MA143-(TX)	G2070536		1-	B	b2
D 5017	DIODE				MA143-(TX)	G2070536		1-	B	b2
D 5018	DIODE				MA143-(TX)	G2070536		1-	B	b2
DS5001	LCD				TTR3165UPFDCW	G6090134		1-	A	C1
DS5001	LCD				A15A012X	G6090159		75-	A	C1
DS5002	LED				NAA261-B	G2090745		1-		
J 5001	CONNECTOR				12FMZ-BT	P1090901		1-	B	e2
JP5001	WIRE ASSY				A1367+	T9206797A		1-	B	b1
Q 5001	IC				DN8657S-E1V	G1092688		1-	B	c1
Q 5002	TRANSISTOR				XN1213-(TX)	G3070194		1-	B	g1
Q 5003	IC				PST596CNR R59-2978	G1092588		1-	B	f2
Q 5004	TRANSISTOR				XN1213-(TX)	G3070194		1-	B	e2
Q 5005	IC				TC7S04FU TE85R	G1091530		1-	B	f1
Q 5006	TRANSISTOR				DTC144EK T146	G3070033		1-	B	f1
Q 5007	IC				HD4074829TF	✖		1-	A	C2
Q 5008	IC				NM93C86AM8(TAPING)	G1092512		1-	A	D1
Q 5008	IC				NM93C86AM8(TAPING)	G1092512		73-	A	D1
Q 5009	TRANSISTOR				DTC144EK T146	G3070033		1-	B	e2
Q 5010	IC				TC7W125FU(TE12L)	G1092923		1-	B	d2
Q 5011	IC				TC7W125FU(TE12L)	G1092923		1-	A	D2
Q 5012	IC				TC7W125FU(TE12L)	G1092923		1-	A	D2
Q 5013	IC				NJM78L05UA-TE1	G1091325		1-	B	f2
R 5001	CHIP RES.	680	1/10W	5%	RMC1/10T 681J	J24205681		1-	B	c1
R 5002	CHIP RES.	470	1/4W	5%	RMC1/4 471JATP	J24245471		1-	B	g2
R 5003	CHIP RES.	470	1/4W	5%	RMC1/4 471JATP	J24245471		1-	B	g1
R 5004	CHIP RES.	5.6k	1/16W	5%	RMC1/16 562JATP	J24185562		1-	B	e1
R 5005	CHIP RES.	4.7k	1/16W	5%	RMC1/16 472JATP	J24185472		1-	A	D2
R 5006	CHIP RES.	47k	1/16W	5%	RMC1/16 473JATP	J24185473		1-	B	f2

Display Unit

Parts List

REF.	DESCRIPTION	VALUE	V/W	TOL.	MFR'S DESIG	VXSTD P/N	VERS.	LOT.	SIDE	LAYADR
R 5007	CHIP RES.	5.6k	1/16W	5%	RMC1/16 562JATP	J24185562		1-	B	e2
R 5008	CHIP RES.	47k	1/16W	5%	RMC1/16 473JATP	J24185473		1-	B	f1
R 5009	CHIP RES.	1M	1/16W	5%	RMC1/16 105JATP	J24185105		1-	B	d1
R 5010	CHIP RES.	47k	1/16W	5%	RMC1/16 473JATP	J24185473		1-	A	D2
R 5011	CHIP RES.	470	1/4W	5%	RMC1/4 471JATP	J24245471		1-	B	f1
R 5012	CHIP RES.	470	1/4W	5%	RMC1/4 471JATP	J24245471		1-	B	f2
R 5013	CHIP RES.	330	1/16W	5%	RMC1/16 331JATP	J24185331		1-	B	e2
R 5014	CHIP RES.	10k	1/16W	5%	RMC1/16 103JATP	J24185103		1-	B	e2
R 5015	CHIP RES.	47k	1/16W	5%	RMC1/16 473JATP	J24185473		1-	B	d2
R 5016	CHIP RES.	10	1W	5%	RMC1 100JTE	J24305100		1-	B	f2
R 5017	CHIP RES.	10k	1/16W	5%	RMC1/16 103JATP	J24185103		1-	B	d2
S 5001	TACT SWITCH				EVQ-333 H=5.0(TAPE)	N5090046		1-	A	F1
S 5002	TACT SWITCH				EVQ-333 H=5.0(TAPE)	N5090046		1-	A	F2
X 5001	XTAL HC-49/U.2S	2.4576MHz			2.4576MHZ	H0103166		1-	B	e1
	LCD HOLDER					RA0014900		1-		
	LIGHT GUIDE					RA0013200		1-		
	REFLECTOR SHEET					RA0013500		1-		
	DIFFUSER SHEET					RA0013600		1-		
	INTER CONNECTOR					RA0013700		1-		
	SPONGE RUBBER					R7130200		1-		
	LED SPACER				LH-5-4	S6000237		1-		
	LED SPACER				LH-5-2	S6000235		1-		

Circuit Diagram

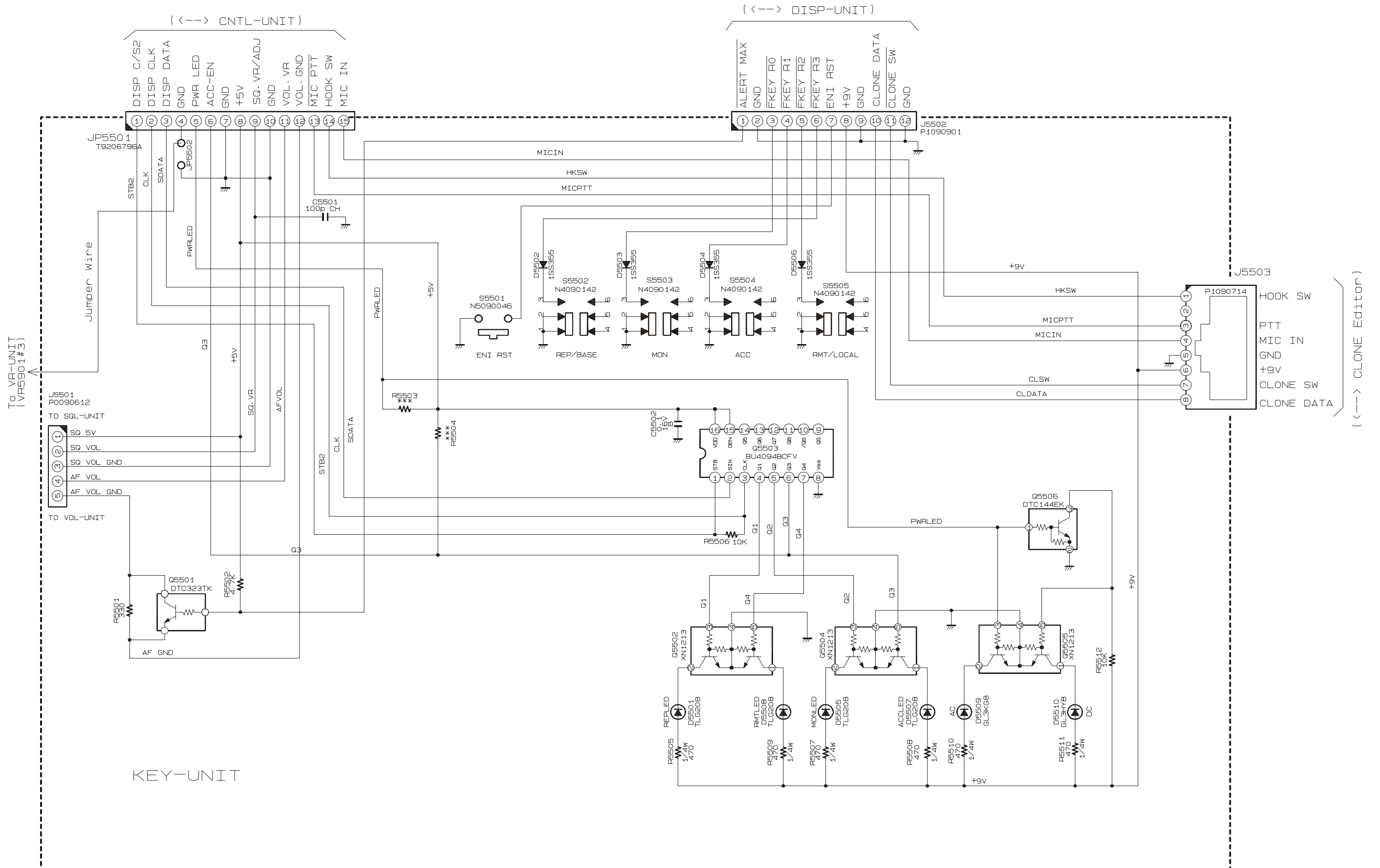

KEY-UNIT

(<--> CLONE Editor)

KEY Unit (Lot. 1~)

Parts Layout

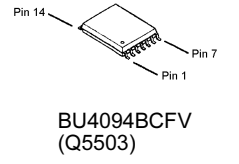
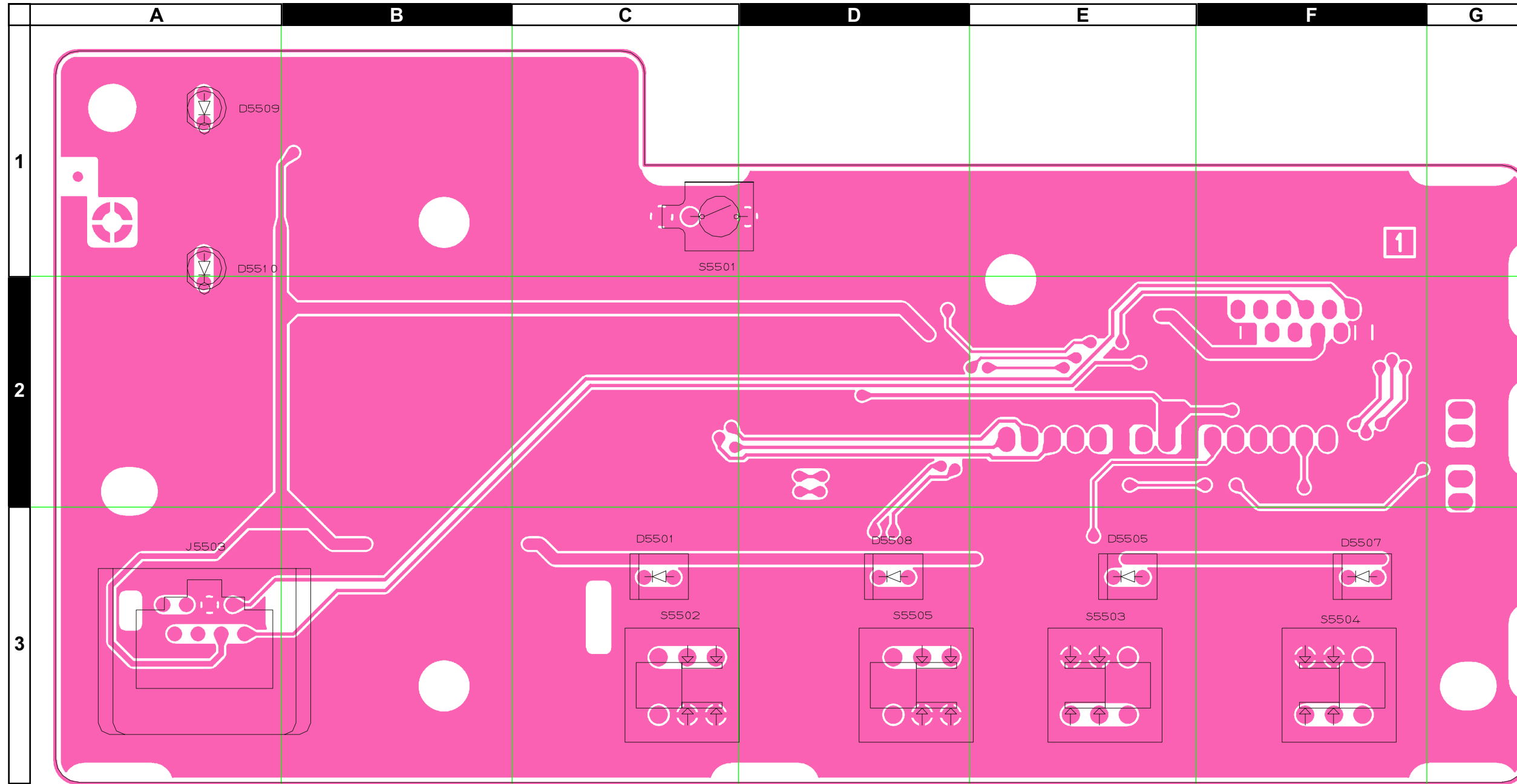

Side A

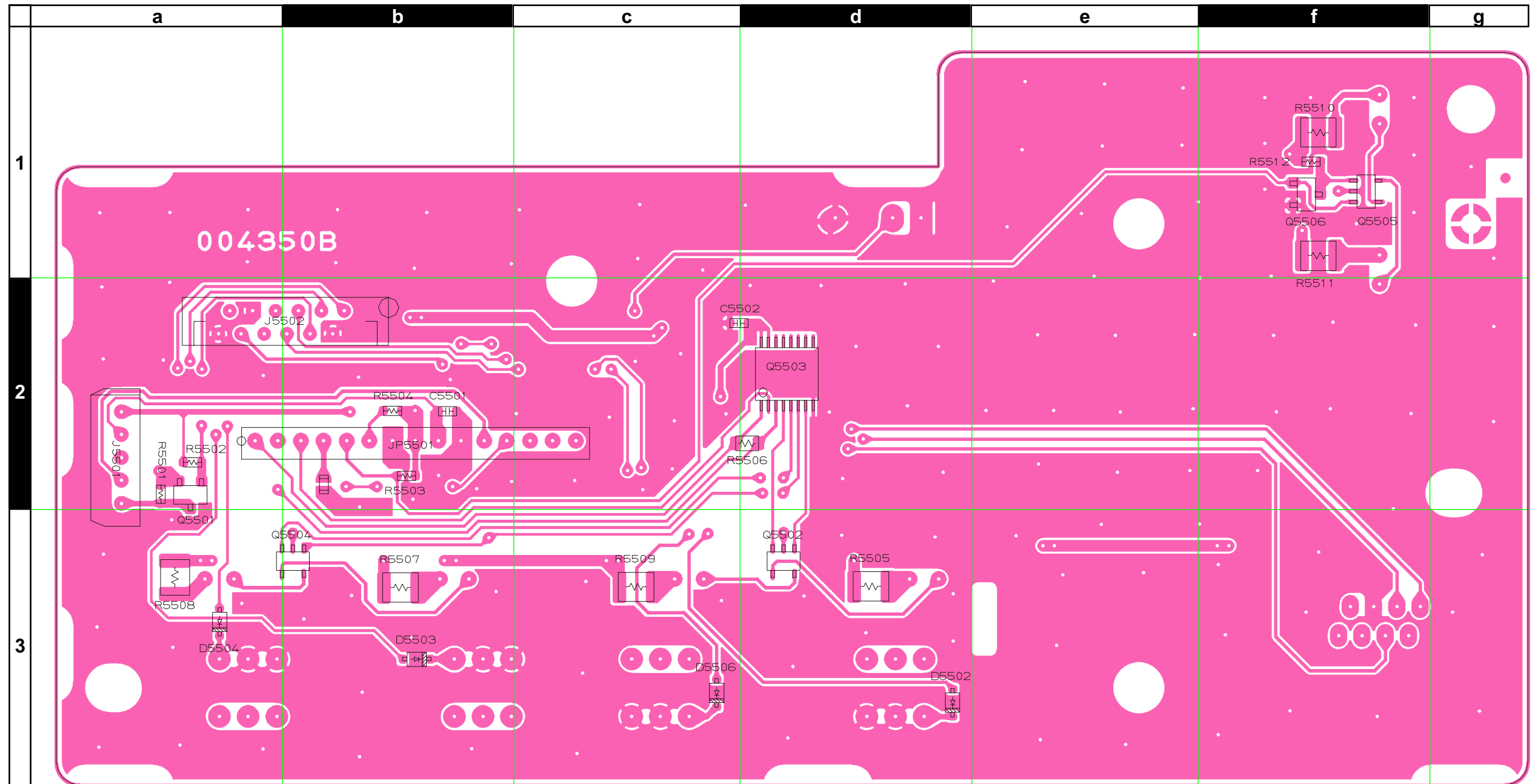
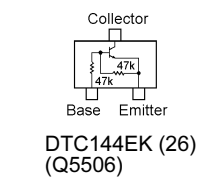
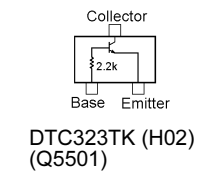
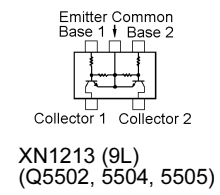

Side B

KEY Unit (Lot. 6~)

Circuit Diagram

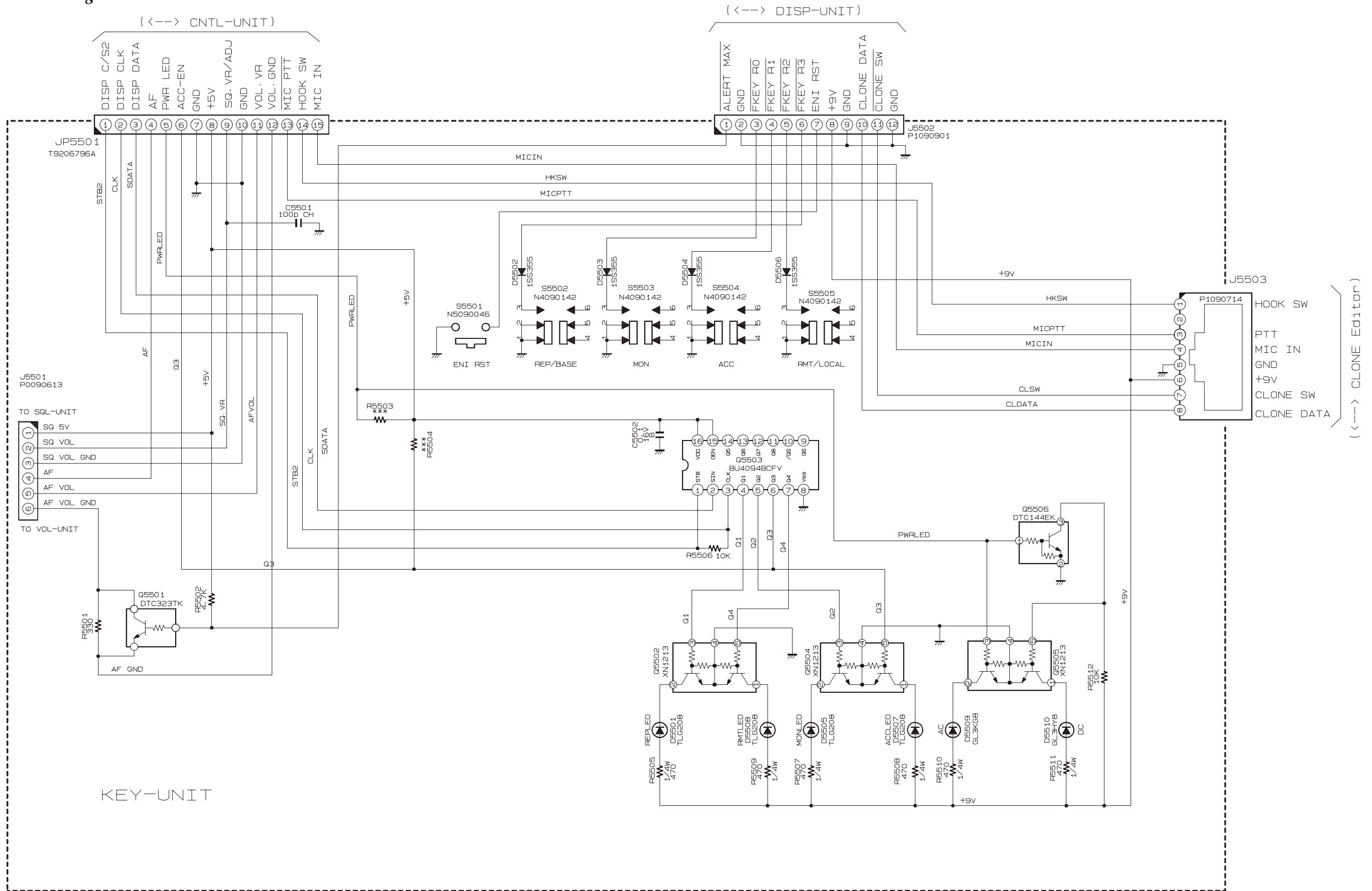

Parts Layout

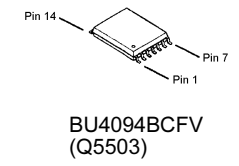
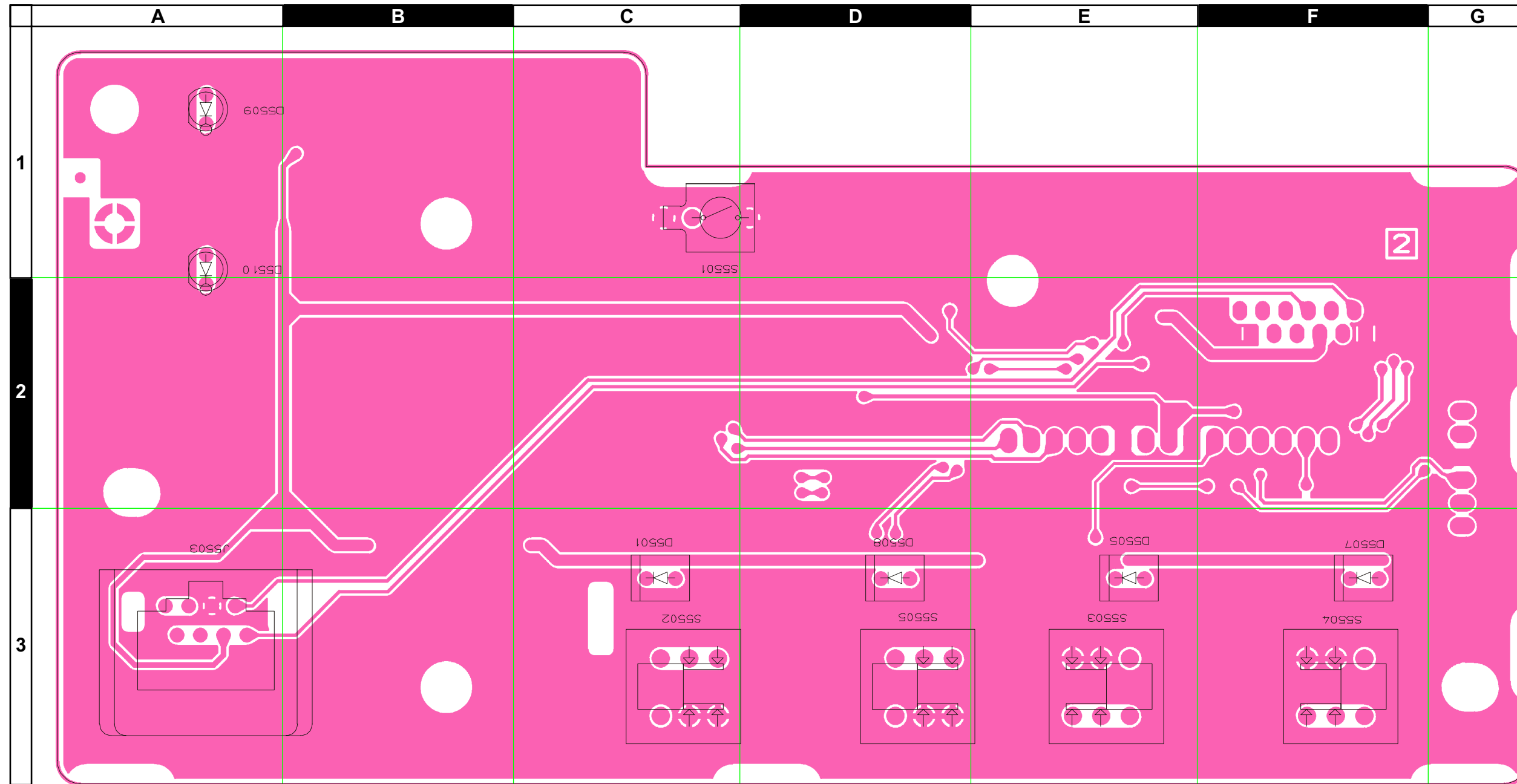

Side A

KEY Unit (Lot. 6~)

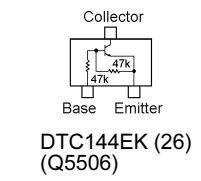
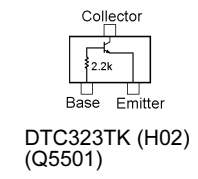
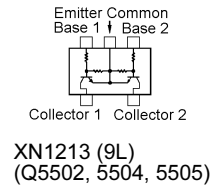
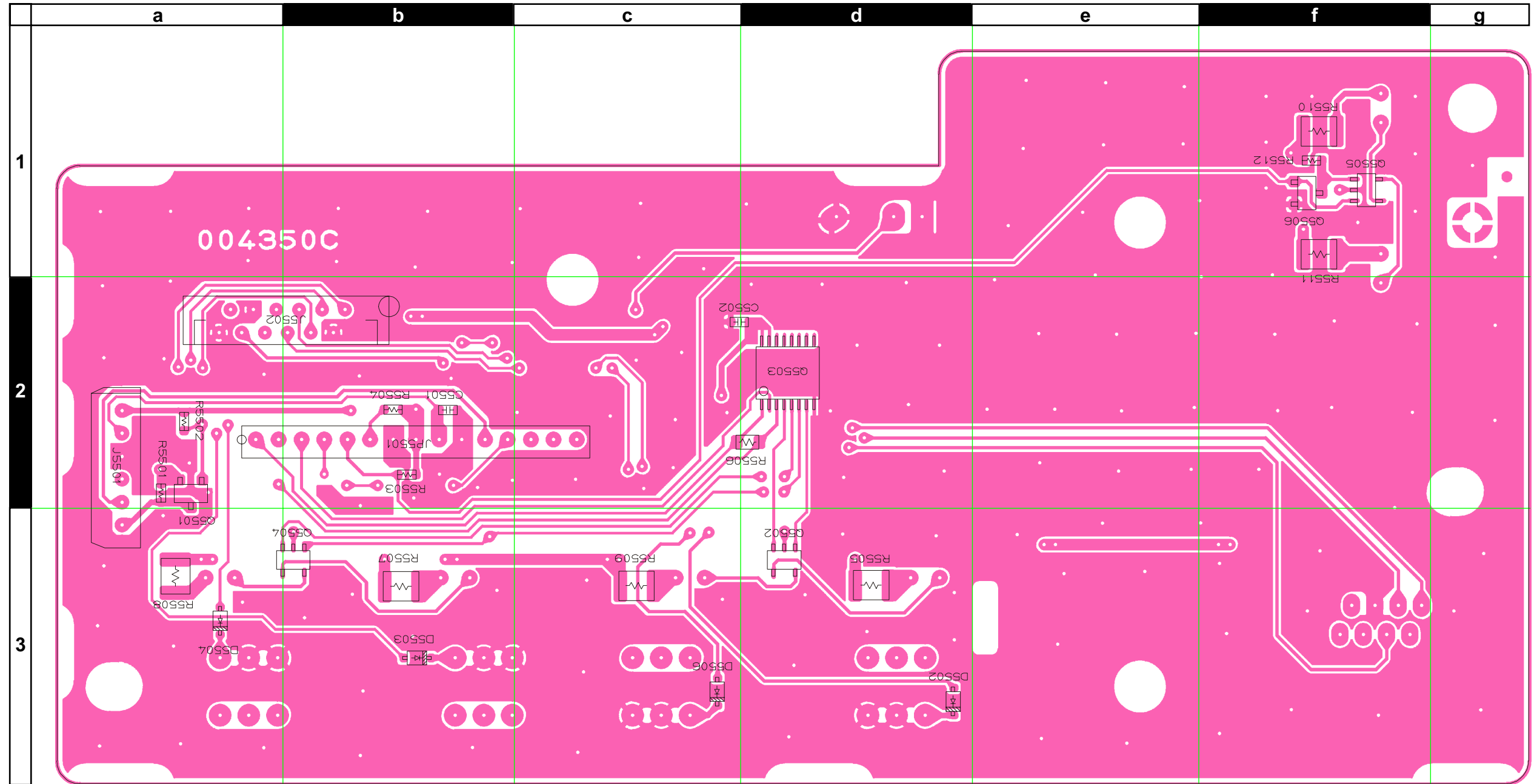

Side B

Key Unit

Parts List

REF.	DESCRIPTION	VALUE	V/W	TOL.	MFR'S DESIG	VXSTD P/N	VERS.	LOT.	SIDE	LAYADR
*** KEY UNIT ***										
PCB with Components						CS1653001				
	Pinted Circuit Board					FR004350C				
C 5501	CHIP CAP.	100pF	50V	CH	GRM1882C1H101JA01D	K22174235		1-	B	b2
C 5502	CHIP CAP.	0.1uF	16V	B	GRM188B11C104KA01D	K22124805		1-	B	c2
D 5501	LED				TLG208	G2090147		1-	A	C3
D 5501	LED				L-4F3GD	G2090789		75-	A	C3
D 5502	DIODE				1SS355 TE-17	G2070470		1-	B	d3
D 5503	DIODE				1SS355 TE-17	G2070470		1-	B	b3
D 5504	DIODE				1SS355 TE-17	G2070470		1-	B	a3
D 5505	LED				TLG208	G2090147		1-	A	E3
D 5505	LED				L-4F3GD	G2090789		75-	A	E3
D 5506	DIODE				1SS355 TE-17	G2070470		1-	B	c3
D 5507	LED				TLG208	G2090147		1-	A	F3
D 5507	LED				L-4F3GD	G2090789		75-	A	F3
D 5508	LED				TLG208	G2090147		1-	A	D3
D 5508	LED				L-4F3GD	G2090789		75-	A	D3
D 5509	LED				GL3KG8	G2090432		1-	A	A1
D 5510	LED				GL3HY8	G2090434		1-	A	A2
J 5501	CONNECTOR				SB20-05WS	P0090612		1-	B	a2
J 5501	CONNECTOR				SB20-06WS	P0090613		6-	B	a2
J 5502	CONNECTOR				12FMZ-BT	P1090901		1-	B	b2
J 5503	CONNECTOR				R41-2509H	P1090714		1-	A	A3
JP5501	WIRE ASSY				A1367+	T9206796A		1-	B	a2
JP5551	WIRE ASSY				GRN 50 2/2	T50505000		3-5		
Q 5501	TRANSISTOR				DTC323TK T146	G3070042		1-	B	a2
Q 5502	TRANSISTOR				XN1213-(TX)	G3070194		1-	B	d3
Q 5503	IC				BU4094BCFV-E1	G1092128		1-	B	d2
Q 5503	IC				BU4094BCFV-E2	G1093527		26-	B	d2
Q 5504	TRANSISTOR				XN1213-(TX)	G3070194		1-	B	b3
Q 5505	TRANSISTOR				XN1213-(TX)	G3070194		1-	B	f1
Q 5506	TRANSISTOR				DTC144EK T146	G3070033		1-	B	f1
R 5501	CHIP RES.	330	1/16W	5%	RMC1/16 331JATP	J24185331		1-	B	a2
R 5502	CHIP RES.	4.7k	1/16W	5%	RMC1/16 472JATP	J24185472		1-	B	a2
R 5505	CHIP RES.	470	1/4W	5%	RMC1/4 471JATP	J24245471		1-	B	d3
R 5506	CHIP RES.	10k	1/10W	5%	RMC1/10T 103J	J24205103		1-	B	d2
R 5507	CHIP RES.	470	1/4W	5%	RMC1/4 471JATP	J24245471		1-	B	b3
R 5508	CHIP RES.	470	1/4W	5%	RMC1/4 471JATP	J24245471		1-	B	a3
R 5509	CHIP RES.	470	1/4W	5%	RMC1/4 471JATP	J24245471		1-	B	c3
R 5510	CHIP RES.	470	1/4W	5%	RMC1/4 471JATP	J24245471		1-	B	f1
R 5511	CHIP RES.	470	1/4W	5%	RMC1/4 471JATP	J24245471		1-	B	f1
R 5512	CHIP RES.	10k	1/16W	5%	RMC1/16 103JATP	J24185103		1-	B	f1
S 5501	TACT SWITCH				EVQ-333 H=5.0(TAPE)	N5090046		1-	A	C1
S 5502	PUSH SWITCH				SPPH110300	N4090142		1-	A	C3
S 5503	PUSH SWITCH				SPPH110300	N4090142		1-	A	E3
S 5504	PUSH SWITCH				SPPH110300	N4090142		1-	A	F3
S 5505	PUSH SWITCH				SPPH110300	N4090142		1-	A	D3
	LED SPACER				LH-3-13	S6000350		1-		
	LED SPACER				LH-5-14	S6000387		1-		
	LED SPACER				LH-5-10	S6000243		1-		

KEY Unit

Note:

Circuit Diagram

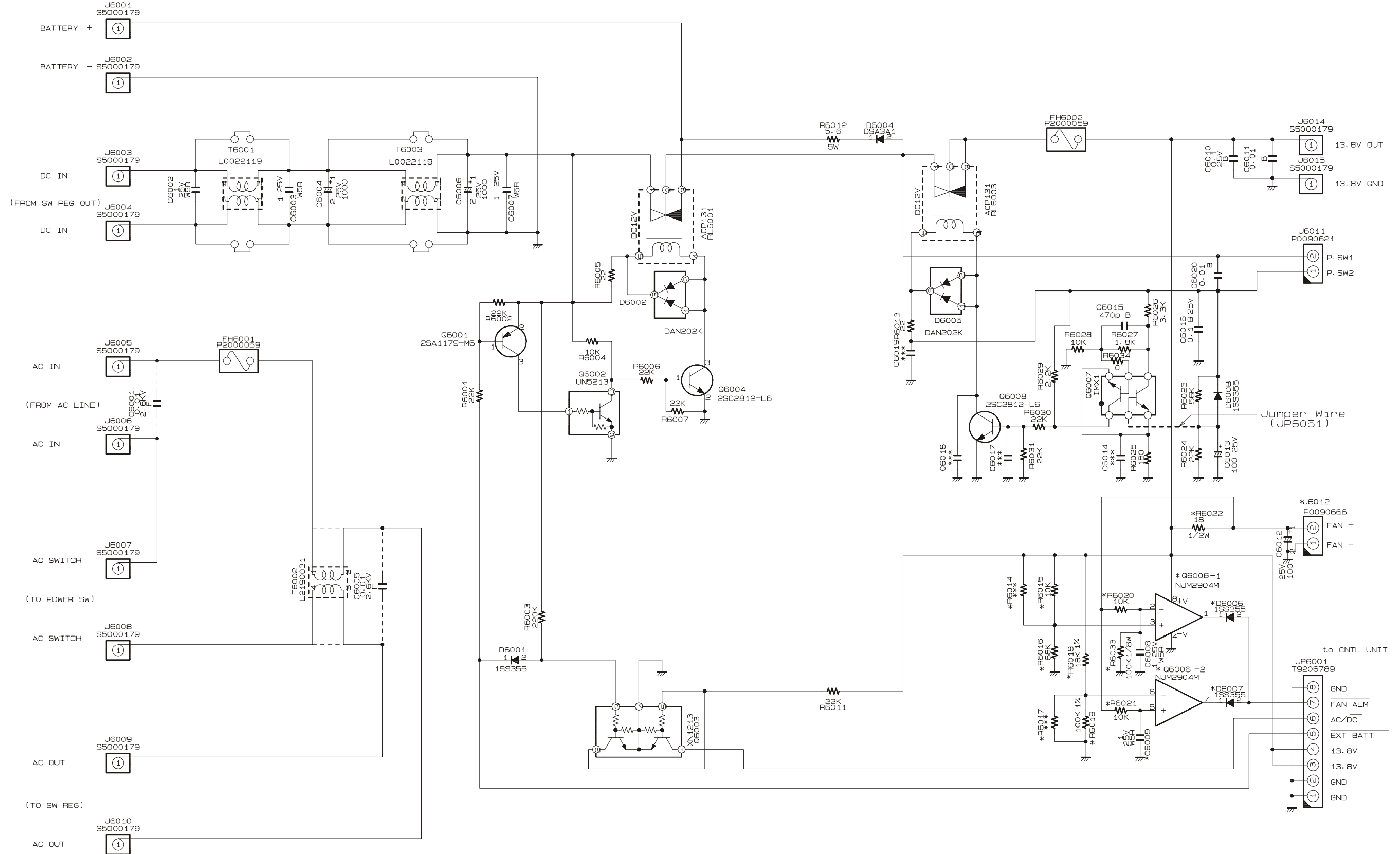

FILTER Unit (Lot. 1~)

Parts Layout

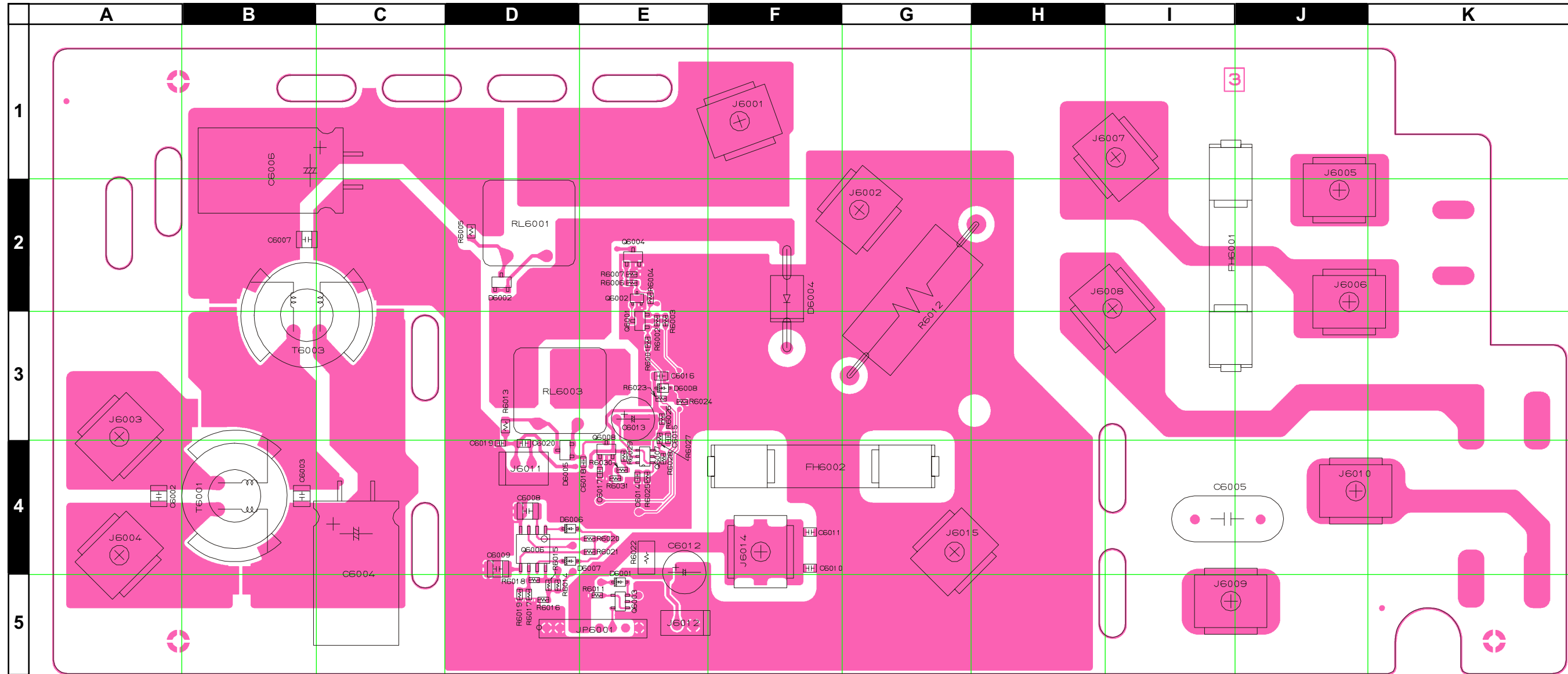

Side A

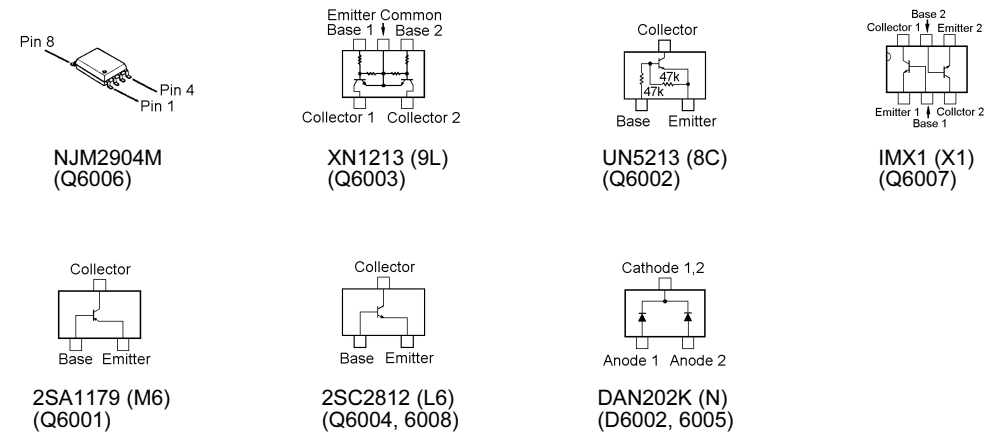

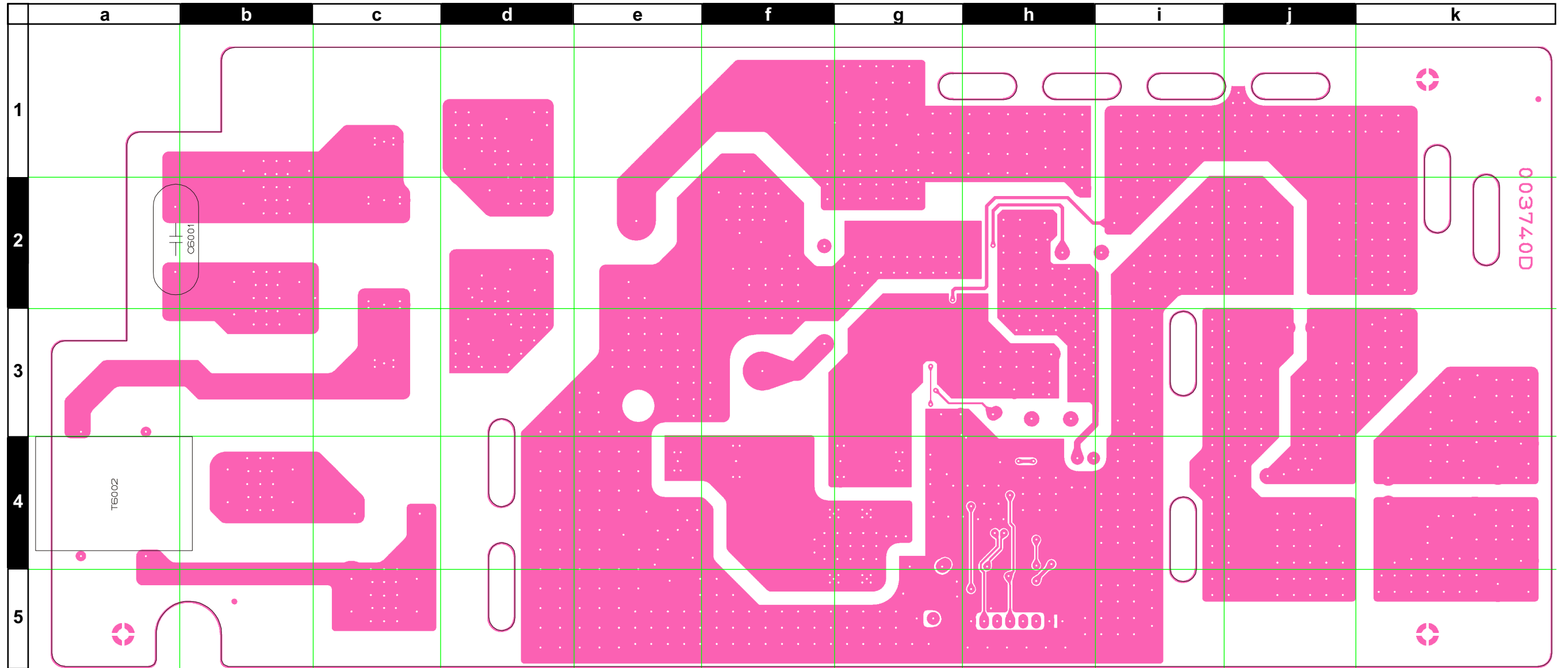

Side B

FILTER Unit (Lot. 6~)

Circuit Diagram

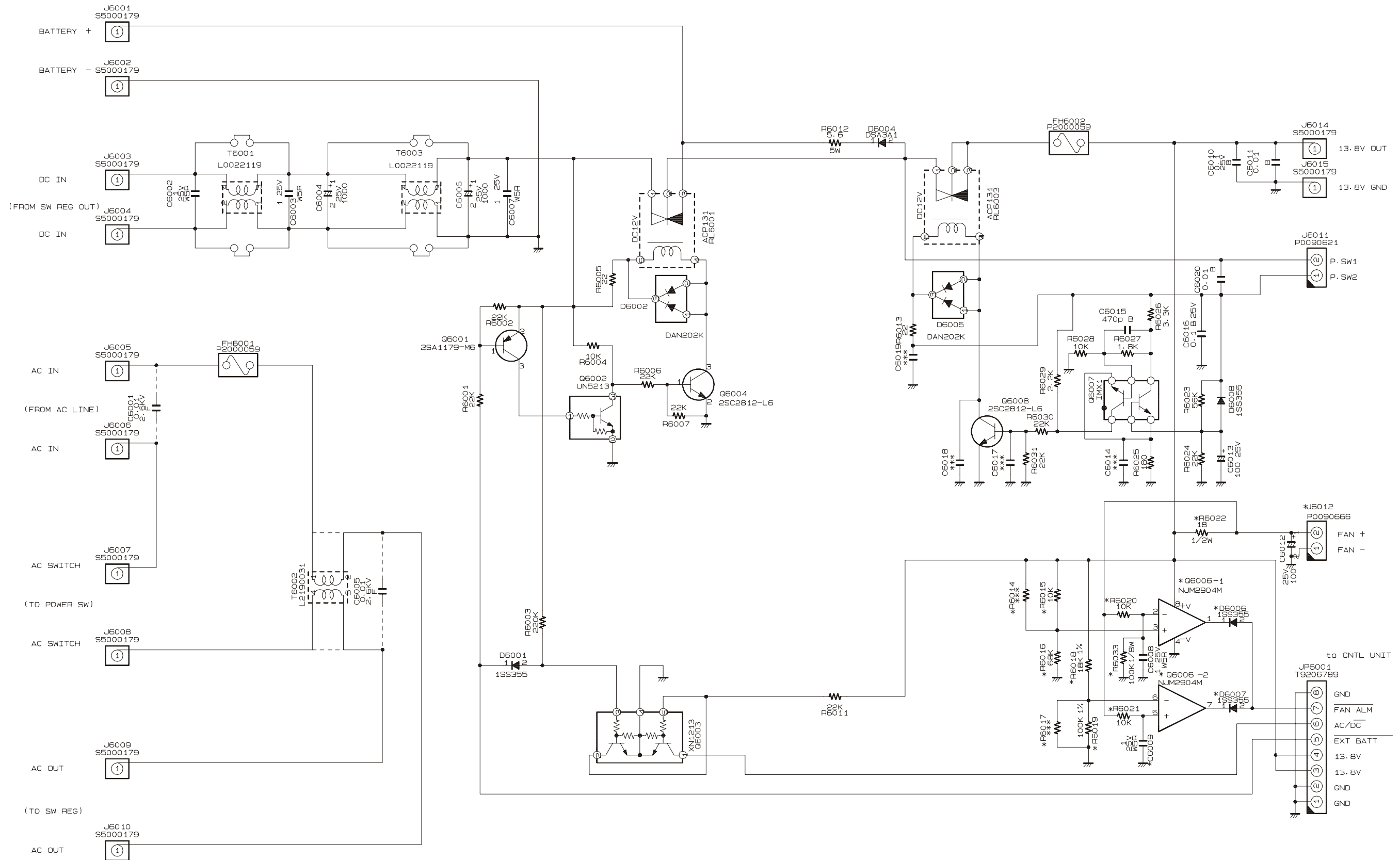

Parts Layout

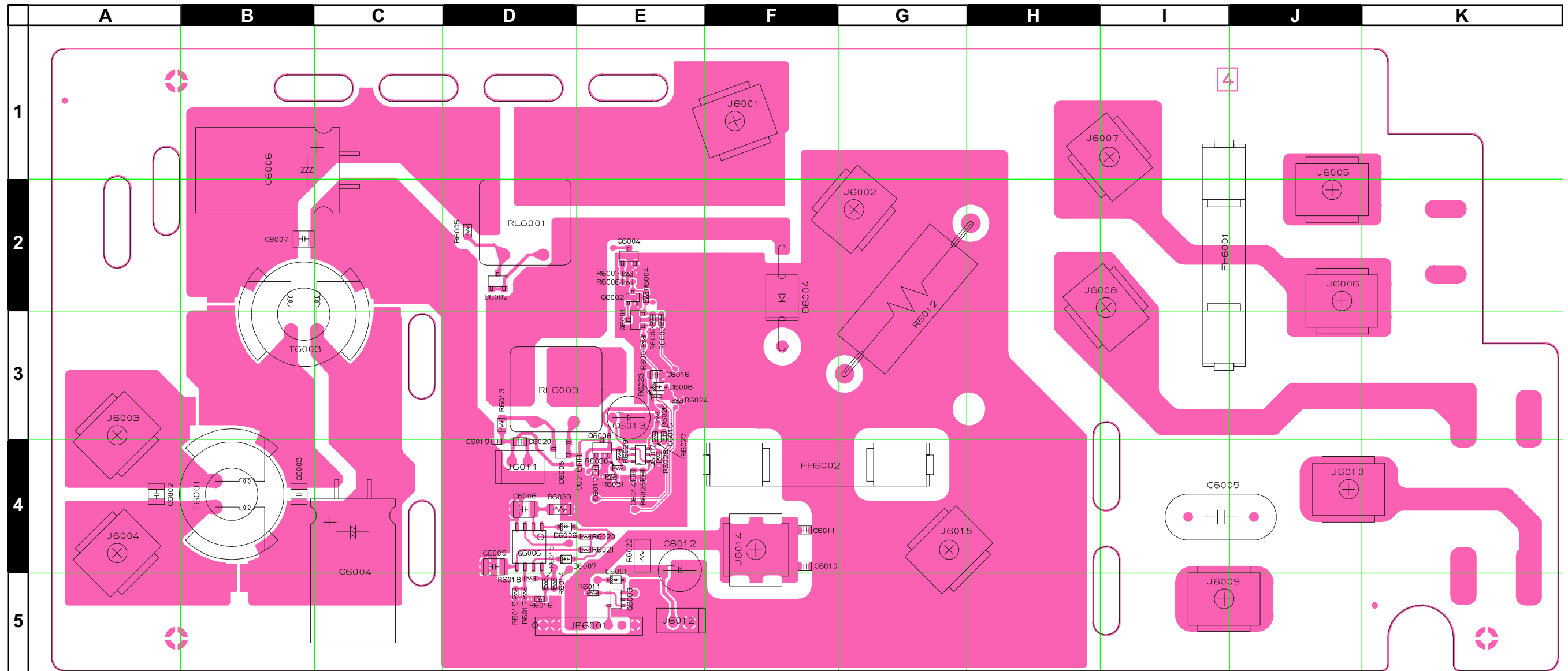

Side A

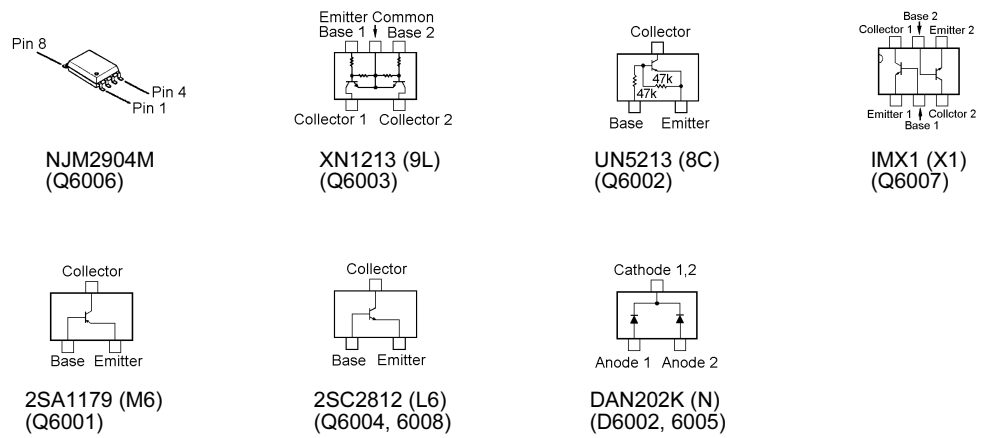

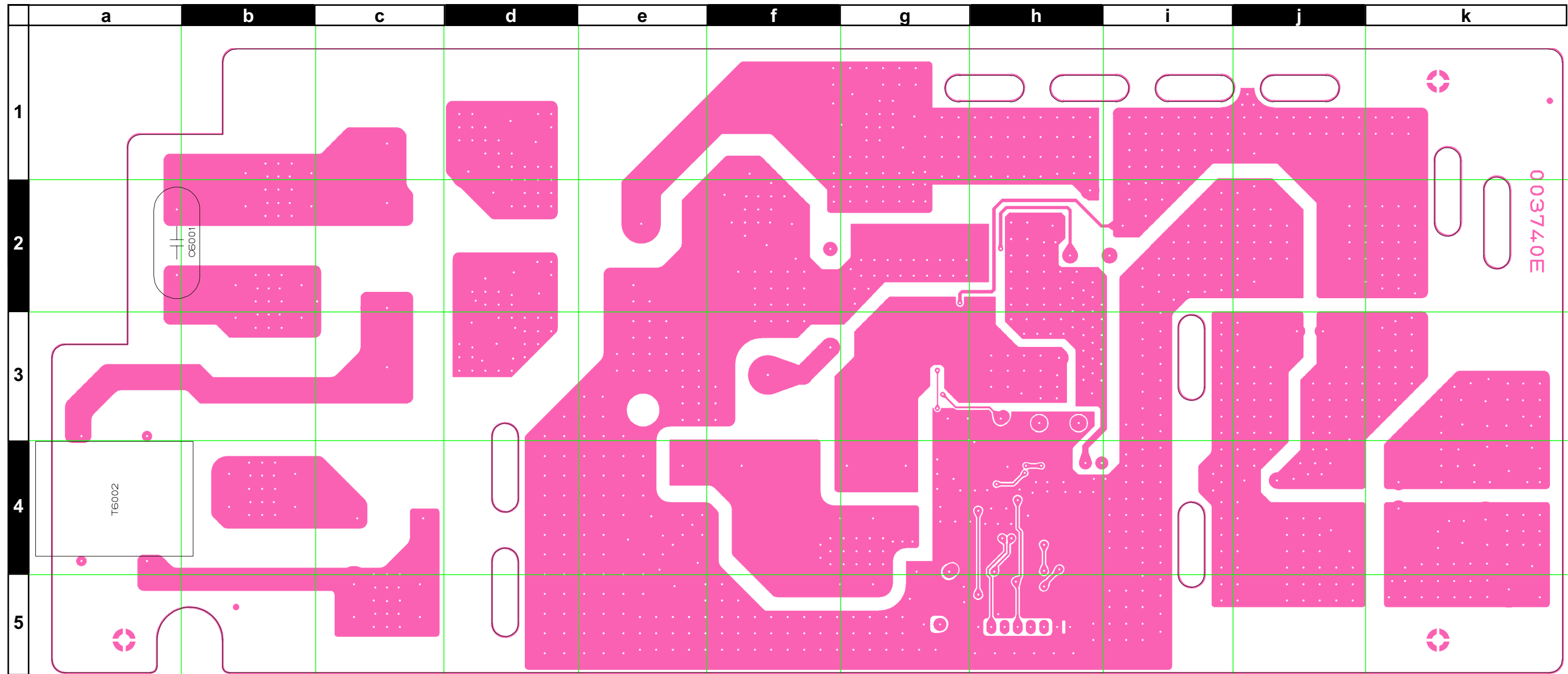

Side B

Filter Unit

Parts List

REF.	DESCRIPTION	VALUE	V/W	TOL.	MFR'S DESIG	VXSTD P/N	VERS.	LOT.	SIDE	LAYADR
*** FILTER UNIT ***										
PCB with Components (w/o F6001 & F6002)						CS1644001				
	Printed Circuit Board					FR003740D		1-		
	Printed Circuit Board					FR003740E		6-		
C 6001	CERAMIC CAP.	0.01uF	2.6KV	F	ECKATS103MF	K13359001	VTX(USA)	1-18	B	a2
C 6002	CHIP CAP.	1uF	25V	W5R	CM32W5R105K25AT	K22145801		1-	A	A4
C 6002	CHIP CAP.	1uF	50V	B	GRM42-2B105K50PT	K22175801		19-	A	A4
C 6003	CHIP CAP.	1uF	25V	W5R	CM32W5R105K25AT	K22145801		1-	A	B4
C 6003	CHIP CAP.	1uF	50V	B	GRM42-2B105K50PT	K22175801		19-	A	B4
C 6004	AL.ELECTRO.CAP.	1000uF	25V		RJ3-25V102MI5#	K40149041		1-	A	C4
C 6005	CERAMIC CAP.	0.01uF	2.6KV	F	ECKATS103MF	K13359001	VTX(USA)	1-18	A	I4
C 6006	AL.ELECTRO.CAP.	1000uF	25V		RJ3-25V102MI5#	K40149041		1-	A	C2
C 6007	CHIP CAP.	1uF	25V	W5R	CM32W5R105K25AT	K22145801		1-	A	B2
C 6007	CHIP CAP.	1uF	50V	B	GRM42-2B105K50PT	K22175801		19-	A	B2
C 6008	CHIP CAP.	1uF	25V	W5R	CM32W5R105K25AT	K22145801		1-	A	D4
C 6008	CHIP CAP.	1uF	50V	B	GRM42-2B105K50PT	K22175801		19-	A	D4
C 6009	CHIP CAP.	1uF	25V	W5R	CM32W5R105K25AT	K22145801		1-	A	D4
C 6009	CHIP CAP.	1uF	50V	B	GRM42-2B105K50PT	K22175801		19-	A	D4
C 6010	CHIP CAP.	0.1uF	25V	B	GRM40B104M25PT	K22140811		1-	A	F4
C 6011	CHIP CAP.	0.01uF	50V	B	GRM40B103M50PT	K22170817		1-	A	F4
C 6012	AL.ELECTRO.CAP.	100uF	25V		RJ3-25V101MF3#-T2	K46140010		1-	A	E4
C 6013	AL.ELECTRO.CAP.	100uF	25V		RJ3-25V101MF3#-T2	K46140010		1-	A	E3
C 6014	CHIP CAP.	0.01uF	25V	B	GRM39B103M25PT	K22144802		72-	A	E4
C 6015	CHIP CAP.	470pF	50V	B	GRM188B11H471KA01D	K22174805		1-	A	E3
C 6016	CHIP CAP.	0.1uF	25V	B	GRM40B104M25PT	K22140811		1-	A	E3
C 6020	CHIP CAP.	0.01uF	50V	B	GRM40B103M50PT	K22170817		1-	A	D4
D 6001	DIODE				1SS355 TE-17	G2070470		1-	A	E5
D 6002	DIODE				DAN202K T146	G2070182		1-	A	D2
D 6004	DIODE				DSA3A1	G2090445		1-	A	F3
D 6005	DIODE				DAN202K T146	G2070182		1-	A	D4
D 6006	DIODE				1SS355 TE-17	G2070470		1-	A	D4
D 6007	DIODE				1SS355 TE-17	G2070470		1-	A	D4
D 6008	DIODE				1SS355 TE-17	G2070470		1-	A	E3
F 6001	FUSE	5A			MF60NR250V 5A	Q0000005		1-	A	F2
F 6002	FUSE	20A			AF20A 20A	Q0000079		1-		
FH6001	FUSE CLIP				S-N5051#01	P2000059		1-	A	I4
FH6002	FUSE CLIP				S-N5051#01	P2000059		1-	A	F4
J 6001	TERMINAL				Y106	S5000179		1-	A	F1
J 6002	TERMINAL				Y106	S5000179		1-	A	G2
J 6003	TERMINAL				Y106	S5000179		1-	A	A3
J 6004	TERMINAL				Y106	S5000179		1-	A	A4
J 6005	TERMINAL				Y106	S5000179		1-	A	J2
J 6006	TERMINAL				Y106	S5000179		1-	A	J2
J 6007	TERMINAL				Y106	S5000179		1-	A	I1
J 6008	TERMINAL				Y106	S5000179		1-	A	I2
J 6009	TERMINAL				Y106	S5000179		1-	A	J4
J 6010	TERMINAL				Y106	S5000179		1-	A	H2
J 6011	CONNECTOR				SC25-02WS	P0090621		1-	A	D4
J 6012	CONNECTOR				B2B-EH	P0090666		1-	A	E5
J 6014	TERMINAL				Y106	S5000179		1-	A	F4
J 6015	TERMINAL				Y106	S5000179		1-	A	G4
JP6001	WIRE ASSY				A1367+	T9206789		1-	A	D5
JP6051	WIRE ASSY				GRN 20 2/2	T50502000		3-5		
Q 6001	TRANSISTOR				2SA1179M6-TA	G3111797F		1-	A	E3
Q 6002	TRANSISTOR				UN5213-(TX)	G3070192		1-	A	E2
Q 6003	TRANSISTOR				XN1213-(TX)	G3070194		1-	A	E5
Q 6004	TRANSISTOR				2SC2812L6-TA	G3328127F		1-	A	E2
Q 6004	TRANSISTOR				2SC2812NL6-TB	G3328128F		18-	A	E2
Q 6006	IC				NJM2904M-TE2	G1093091		1-	A	D4
Q 6007	TRANSISTOR				IMX1 T110	G3070024		1-	A	E4
Q 6008	TRANSISTOR				2SC2812L6-TA	G3328127F		1-	A	E4
Q 6008	TRANSISTOR				2SC2812NL6-TB	G3328128F		18-	A	E4
R 6001	CHIP RES.	22k	1/16W	5%	RMC1/16 223JATP	J24185223		1-	A	E3
R 6002	CHIP RES.	22k	1/16W	5%	RMC1/16 223JATP	J24185223		1-	A	E3
R 6003	CHIP RES.	220k	1/16W	5%	RMC1/16 224JATP	J24185224		1-	A	E3
R 6004	CHIP RES.	10k	1/16W	5%	RMC1/16 103JATP	J24185103		1-	A	E2
R 6005	CHIP RES.	22	1/10W	5%	RMC1/10T 220J	J24205220		1-	A	D2

Filter Unit

Parts List

REF.	DESCRIPTION	VALUE	V/W	TOL.	MFR'S DESIG	VXSTD P/N	VERS.	LOT.	SIDE	LAYADR
R 6006	CHIP RES.	22k	1/16W	5%	RMC1/16 223JATP	J24185223		1-	A	E2
R 6007	CHIP RES.	22k	1/16W	5%	RMC1/16 223JATP	J24185223		1-	A	E2
R 6011	CHIP RES.	22k	1/16W	5%	RMC1/16 223JATP	J24185223		1-	A	E5
R 6012	CEMENT RES.	5.6	5W	10%	ERF-5AK5R6	J30376569		1-	A	H2
R 6013	CHIP RES.	22	1/10W	5%	RMC1/10T 220J	J24205220		1-	A	D3
R 6015	CHIP RES.	10k	1/16W	5%	RMC1/16 103JATP	J24185103		1-	A	D5
R 6016	CHIP RES.	68k	1/16W	5%	RMC1/16 683JATP	J24185683		1-	A	D5
R 6018	CHIP RES.	18k	1/16W	1%	RMC1/16 183FTP	J24183183		1-	A	D5
R 6019	CHIP RES.	100k	1/16W	1%	RMC1/16 104FTP	J24183104		1-	A	D5
R 6020	CHIP RES.	10k	1/16W	5%	RMC1/16 103JATP	J24185103		1-	A	E4
R 6021	CHIP RES.	10k	1/16W	5%	RMC1/16 103JATP	J24185103		1-	A	E4
R 6022	CHIP RES.	18	1/2W	5%	RMC1/2 180JTE	J24275180		1-	A	E4
R 6023	CHIP RES.	56k	1/16W	5%	RMC1/16 563JATP	J24185563		1-	A	E3
R 6024	CHIP RES.	22k	1/16W	5%	RMC1/16 223JATP	J24185223		1-	A	E3
R 6025	CHIP RES.	180	1/16W	5%	RMC1/16 181JATP	J24185181		1-	A	E4
R 6026	CHIP RES.	3.3k	1/16W	5%	RMC1/16 332JATP	J24185332		1-	A	E3
R 6027	CHIP RES.	1.8k	1/16W	5%	RMC1/16 182JATP	J24185182		1-	A	E3
R 6028	CHIP RES.	10k	1/16W	5%	RMC1/16 103JATP	J24185103		1-	A	E4
R 6029	CHIP RES.	2.2k	1/16W	5%	RMC1/16 222JATP	J24185222		1-	A	E4
R 6030	CHIP RES.	22k	1/16W	5%	RMC1/16 223JATP	J24185223		1-	A	E4
R 6031	CHIP RES.	22k	1/16W	5%	RMC1/16 223JATP	J24185223		1-	A	E4
R 6033	CHIP RES.	100k	1/8W	5%	RMC1/8T 104J	J24215104		1-	A	D4
R 6034	CHIP RES.	0	1/16W	5%	RMC1/16 000JATP	J24185000		1-5		
RL6001	RELAY		DC12V		ACP131 DC12V	M1190152		1-	A	D2
RL6003	RELAY		DC12V		ACP131 DC12V	M1190152		1-	A	D3
T 6001	TOROIDAL COIL				D12A RI16X8X8	L0022119	VTX(USA)	1-18	A	B4
T 6002	TOROIDAL COIL				SC-05-100	L2190031		1-18	B	a3
T 6003	TOROIDAL COIL				D12A RI16X8X8	L0022119		1-18	A	B3
	RUBBER					RA0217100		17-		

Circuit Diagram

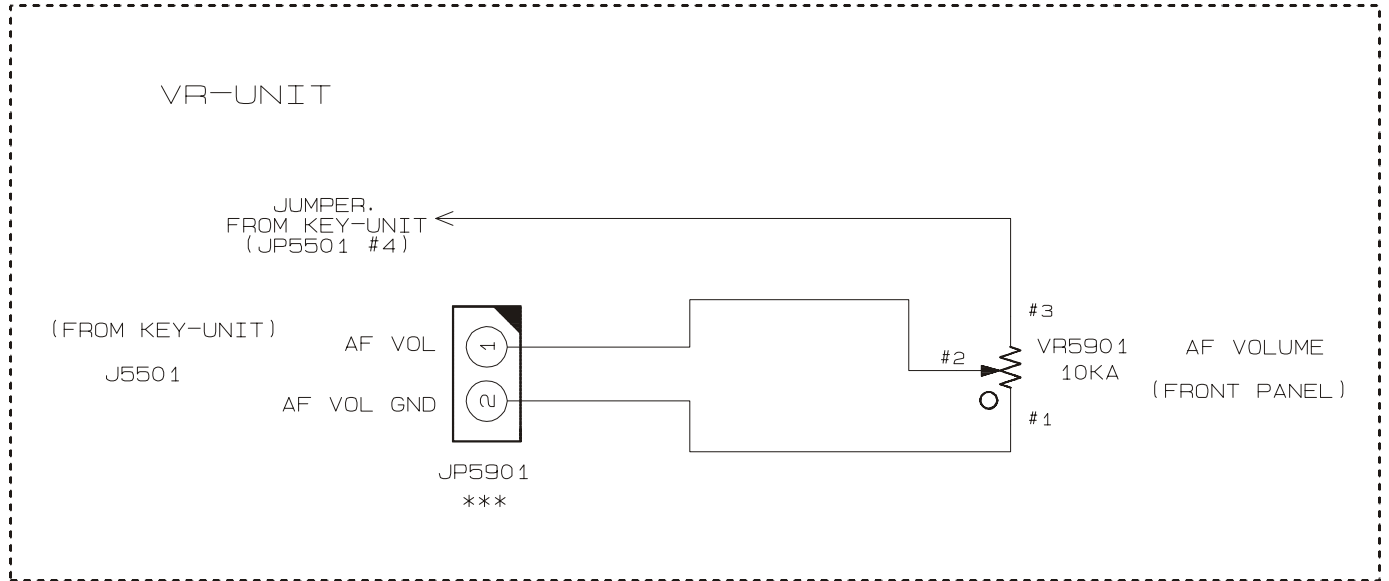

Parts Layout

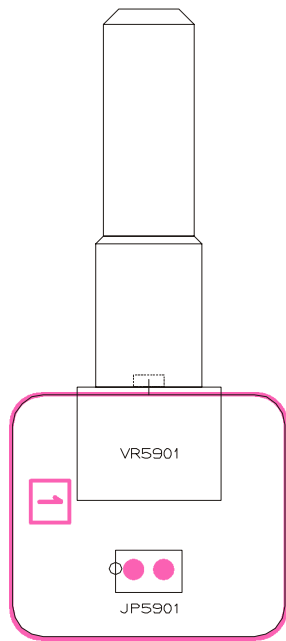

Side A



Side B

VR Unit (Lot. 6~)

Circuit Diagram

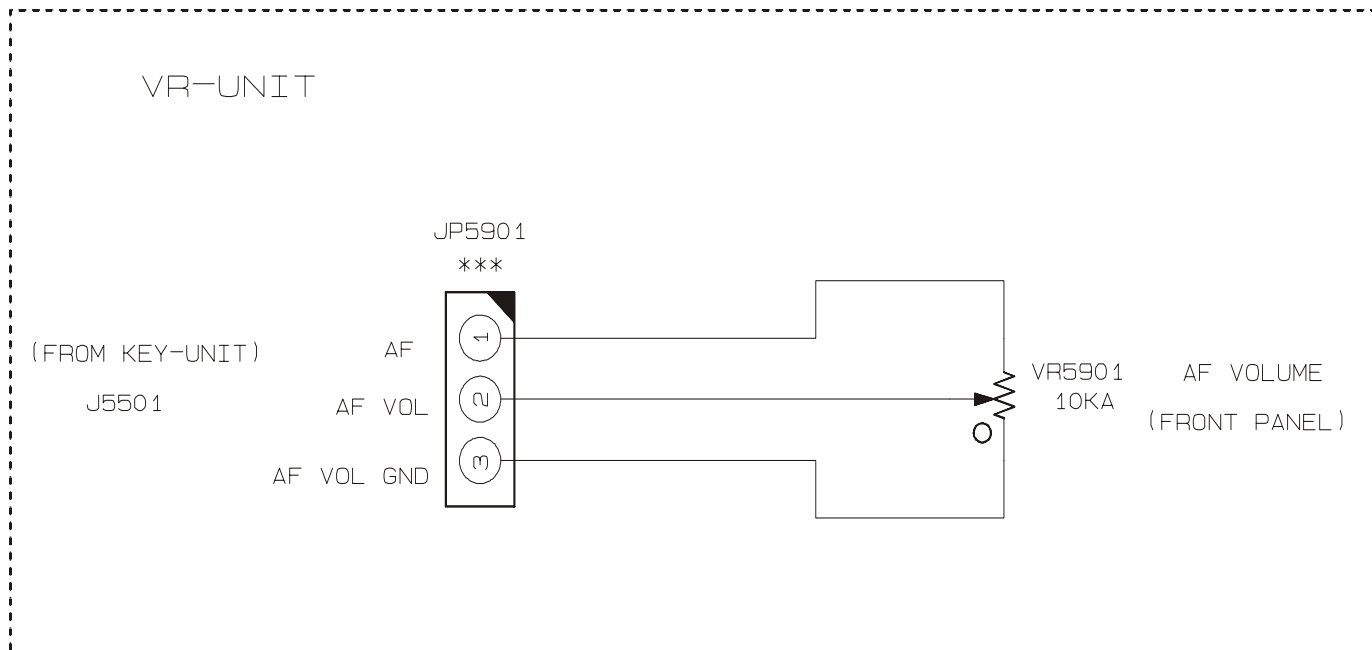

Parts Layout

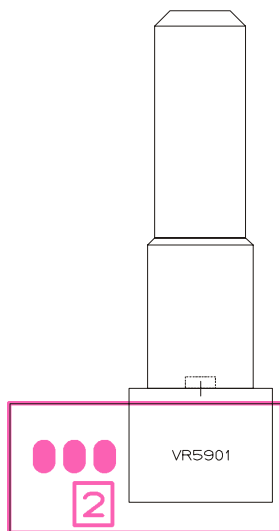

Side A

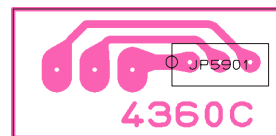

Side B

Parts List

REF.	DESCRIPTION	VALUE	V/W	TOL.	MFR'S DESIG	VXSTD P/N	VERS.	LOT.	SIDE
	PCB with Components					CS1648001			
	Printed Circuit Board					FR004360B		1-	
						FR004360C		6-	
VR5901	POT.				RK0971110 10KA(L=25)	J60800241		1-	A

Circuit Diagram

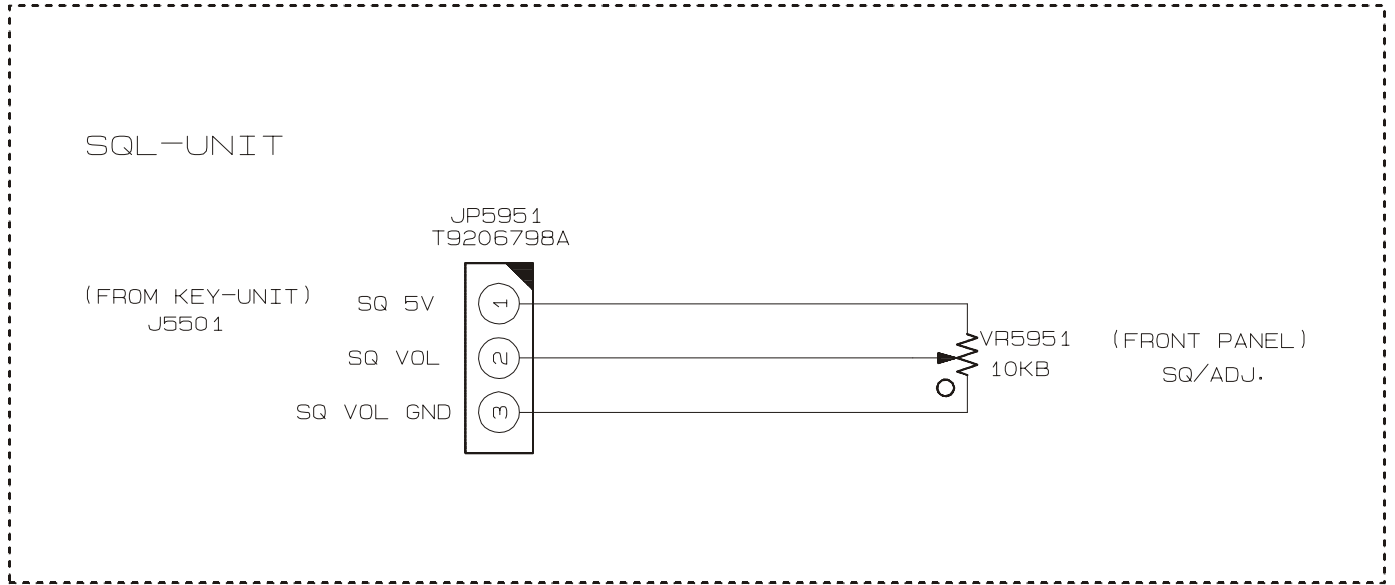

Parts Layout

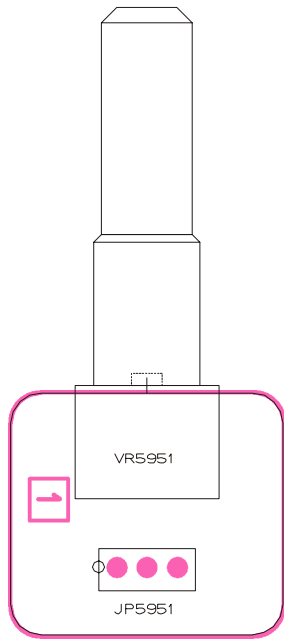

Side A

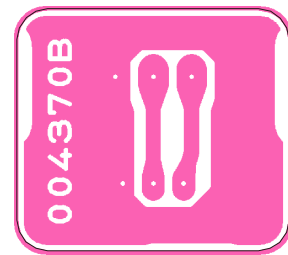

Side B

SQL Unit (Lot. 6~)

Circuit Diagram

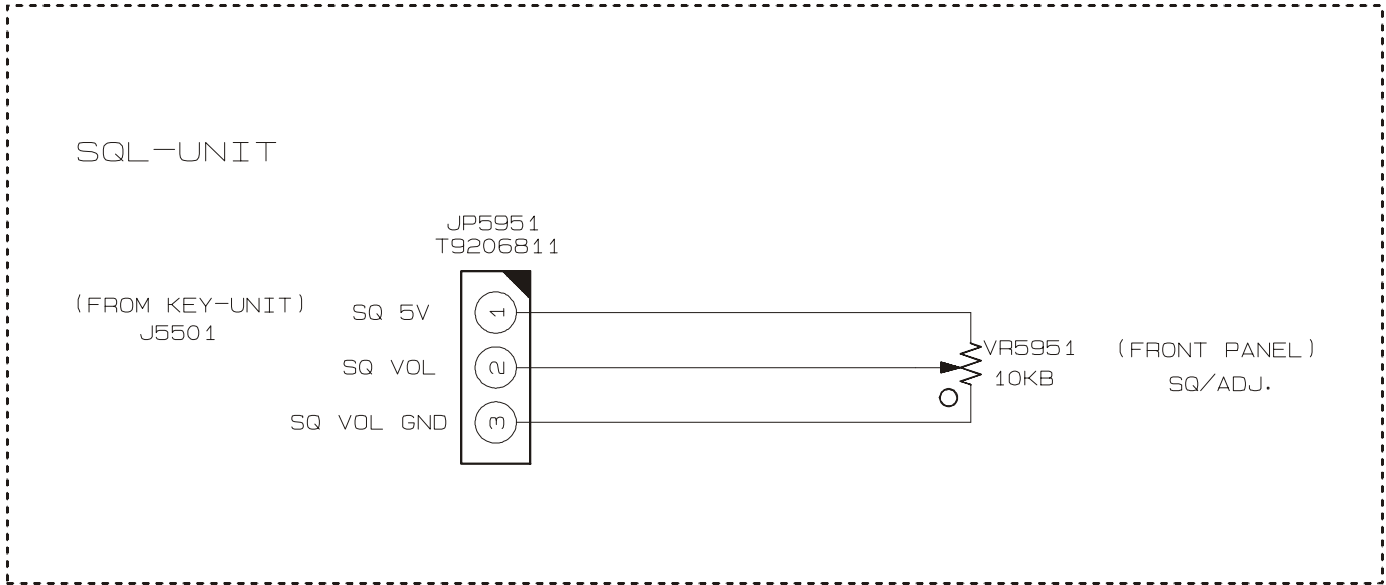

Parts Layout

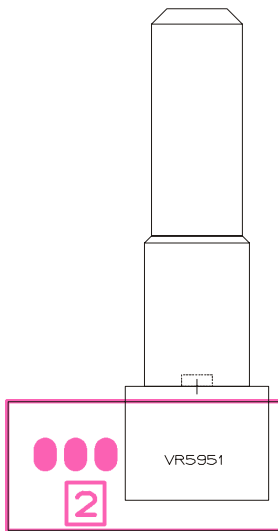

Side A

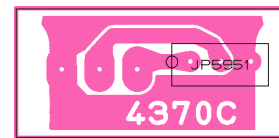

Side B

Parts List

REF.	DESCRIPTION	VALUE	V/W	TOL.	MFR'S DESIG	VXSTD P/N	VERS.	LOT.	SIDE
PCB with Components						CS1649001			
Printed Circuit Board						FR004370B		1-	
						FR004370C		6-	
JP5951	WIRE ASSY				A1367+	T9206798A		1-	A
JP5951	WIRE ASSY				A1367+	T9206811		6-	A
VR5951	POT.				RK0971110 10KB(L=25)	J60800242		1-	A

Circuit Diagram

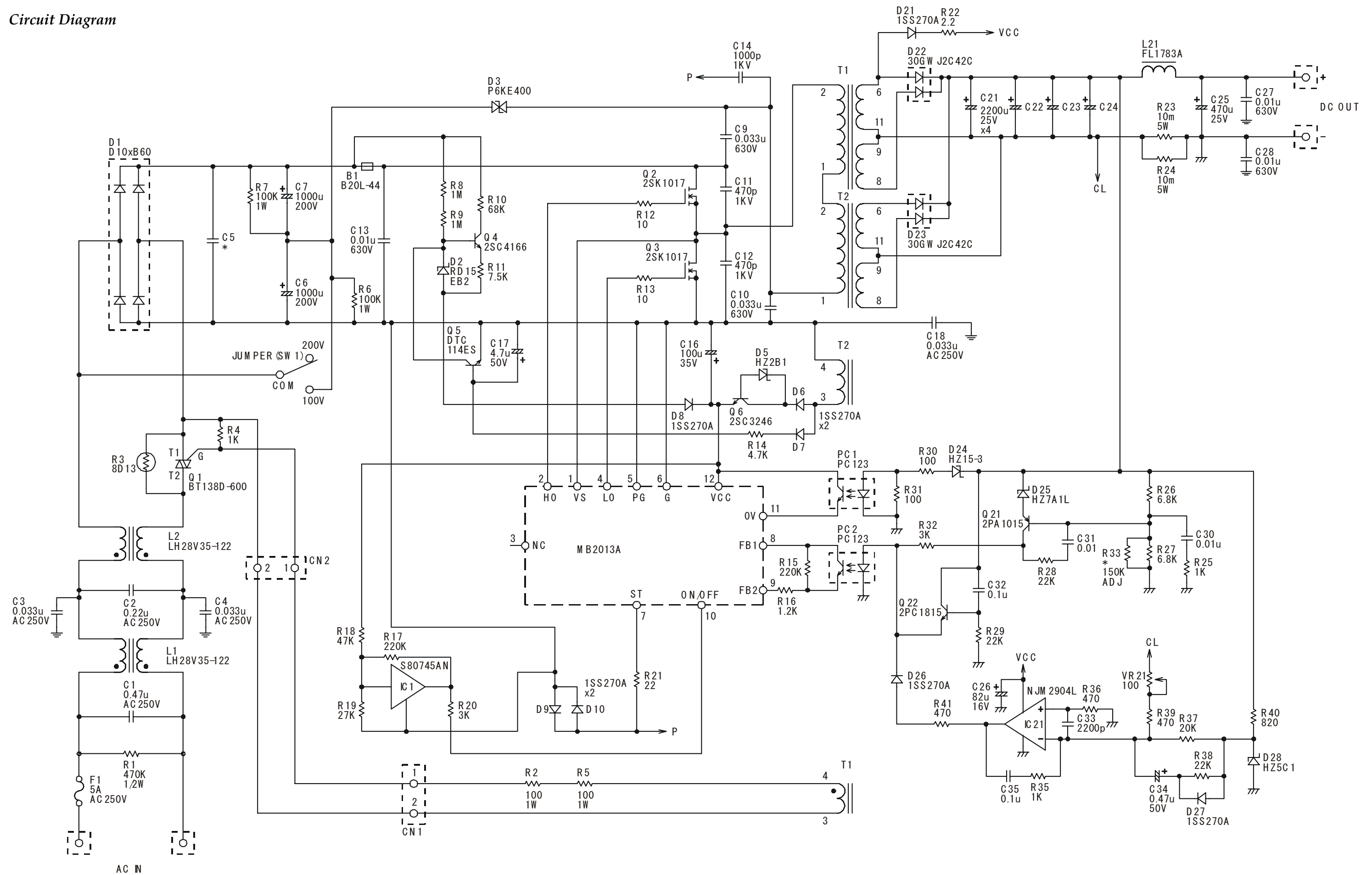

PS Unit

Parts Layout

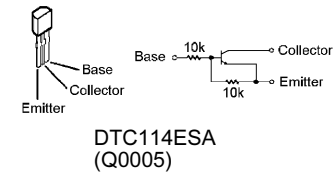
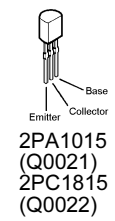
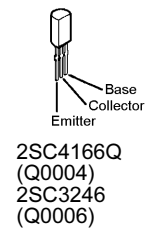
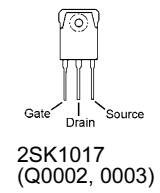
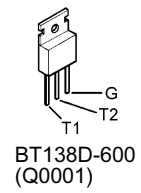
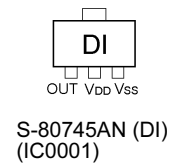
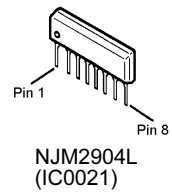
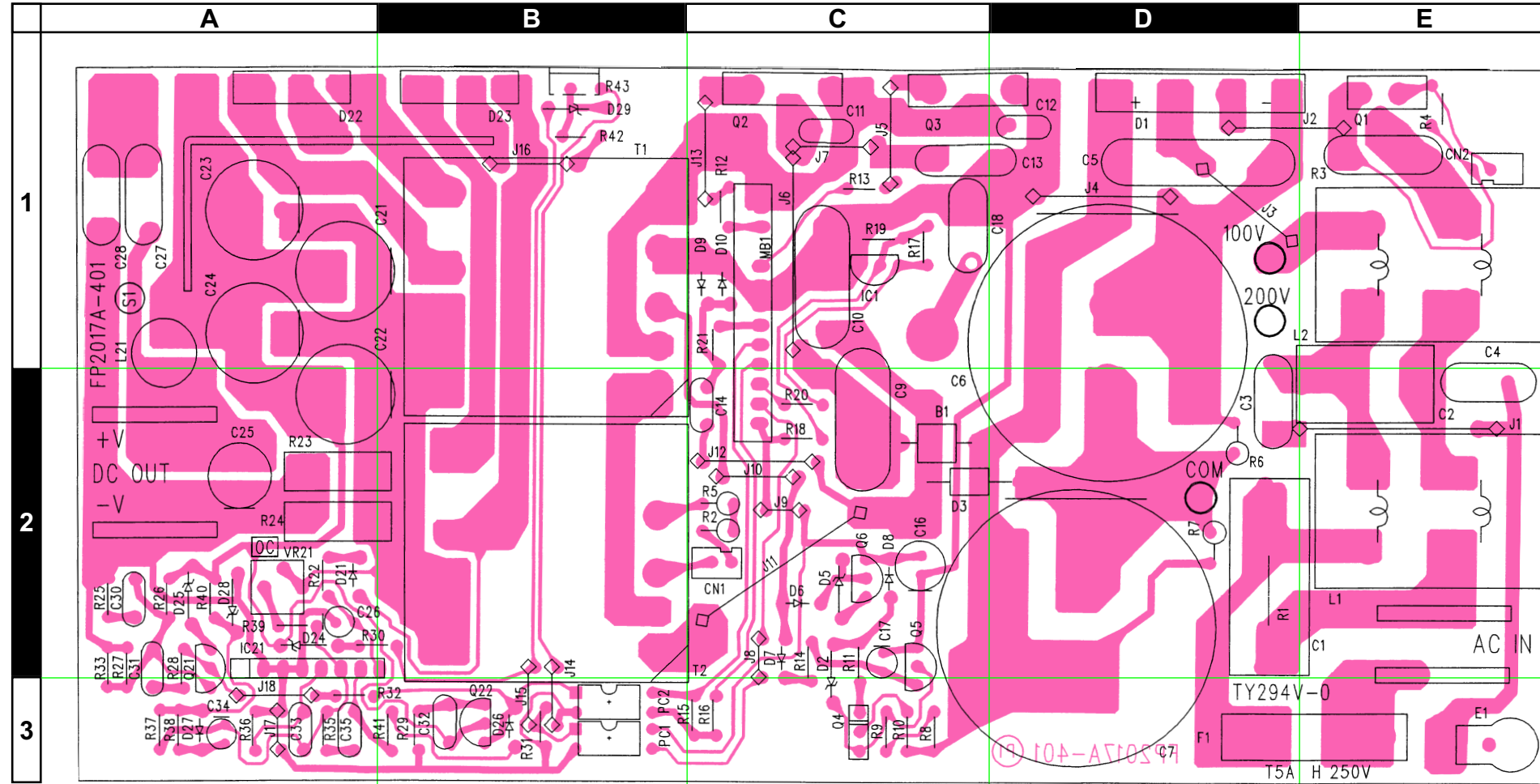

Parts List

REF.	DESCRIPTION	VALUE	V/W	TOL.	MFR'S DESIG	VXSTD P/N	VERS.	LOT.	SIDE
B 0001	FERRITE BEADS				B-20L-44	L9190120		1-	C2
C 0001	FILM CAP.	0.47uF	250V		ECQU2A474MG	K52240008		1-	D2
C 0002	FILM CAP.	0.22uF	250V		ECQU2A224MG	K52240007		1-	E2
C 0003	CERAMIC CAP.	0.0033uF		E	ECKDRS332MEY	K12269003		1-	D2
C 0004	CERAMIC CAP.	0.0033uF		E	ECKDRS332MEY	K12269003		1-	E2
C 0006	AL.ELECTRO.CAP.	1000uF	200V		KMM200VNSN1000M30D	K40239006		1-	D1
C 0007	AL.ELECTRO.CAP.	1000uF	200V		KMM200VNSN1000M30D	K40239006		1-	D2
C 0009	FILM CAP.	0.033uF	800V		QXF2K333JRPT	K52290001		1-	C2
C 0010	FILM CAP.	0.033uF	800V		QXF2K333JRPT	K52290001		1-	C1
C 0011	CERAMIC CAP.	470pF	1kV	R	DE0705R471K1K	K10309002		1-	C1
C 0012	CERAMIC CAP.	470pF	1kV	R	DE0705R471K1K	K10309002		1-	C1
C 0013	FILM CAP.	0.01uF	630V		MMC103K-630	K52280009		1-	C1
C 0014	CERAMIC CAP.	0.001uF	1kV	B	ECKD3A102KBP	K10309001		1-	C2
C 0016	AL.ELECTRO.CAP.	100uF	35V		ECA1VHG101	K40169036		1-	C2
C 0017	AL.ELECTRO.CAP.	4.7uF	50V		ECA1HHG4R7	K40179074		1-	C2
C 0018	CERAMIC CAP.	0.0033uF		E	ECKDRS332MEY	K12269003		1-	C1
C 0021	AL.ELECTRO.CAP.	2200uF	25V		EEUFC1E222	K40149063		1-	A1
C 0022	AL.ELECTRO.CAP.	2200uF	25V		EEUFC1E222	K40149063		1-	A2
C 0023	AL.ELECTRO.CAP.	2200uF	25V		EEUFC1E222	K40149063		1-	A1
C 0024	AL.ELECTRO.CAP.	2200uF	25V		EEUFC1E222	K40149063		1-	A1
C 0025	AL.ELECTRO.CAP.	470uF	25V		EEUFC1E471L	K40149064		1-	A2
C 0026	AL.ELECTRO.CAP.	82uF	16V		EEUFC1C820	K40129094		1-	A2
C 0027	FILM CAP.	0.01uF	630V		MMC103K630	K52280009		1-	A1
C 0028	FILM CAP.	0.01uF	630V		MMC103K630	K52280009		1-	A1
C 0030	FILM CAP.	0.01uF	50V		ECQB1H103KF	K50170102		1-	A2
C 0031	FILM CAP.	0.01uF	50V		ECQB1H103KF	K50170102		1-	A2
C 0032	FILM CAP.	0.1uF	50V		ECQV1H104JL	K52170020		1-	B3
C 0033	FILM CAP.	0.0022uF	50V		ECQB1H222KF	K50170103		1-	A3
C 0034	AL.ELECTRO.CAP.	0.47uF	50V		ECA1HHGR47	K40179075		1-	A3
C 0035	FILM CAP.	0.1uF	50V		ECQV1H104JL	K52170020		1-	A3
D 0001	DIODE				D10XB60	G2090753		1-	D1
D 0002	DIODE				RD15EB2	G2090507		1-	C2
D 0003	DIODE				P6KE400C	G2090759		1-	C2
D 0005	DIODE				HZ2B1	G2090755		1-	C2
D 0006	DIODE				1SS270A	G2090754		1-	C2
D 0007	DIODE				1SS270A	G2090754		1-	C2
D 0008	DIODE				1SS270A	G2090754		1-	C2
D 0009	DIODE				1SS270A	G2090754		1-	C1
D 0010	DIODE				1SS270A	G2090754		1-	C1
D 0021	DIODE				1SS270A	G2090754		1-	A2
D 0022	DIODE				30GWJ2C42C	G2090758		1-	A1
D 0023	DIODE				30GWJ2C42C	G2090758		1-	B1
D 0024	DIODE				HZ15-3	G2090756		1-	A2
D 0025	DIODE				HZ7A1L	G2090757		1-	A2
D 0026	DIODE				1SS270A	G2090754		1-	B3
D 0027	DIODE				1SS270A	G2090754		1-	A3
D 0028	DIODE				HZ5C1	G2090188		1-	A2
F 0001	FUSE				215005	Q0000092		1-	E3
IC0001	IC				S-80745AN-D9-T1	G1092610		1-	C1
IC0021	IC				NJM2904L	G1093156		1-	A2
L 0001	LINE FILTER				LH28V35-122	S8100821		1-	E2
L 0002	LINE FILTER				LH28V35-122	S8100821		1-	E2
L 0021	RFC				FL1783A	S8100206		1-	A1
L 0022	RFC				FL1783A	S8100206		1-	A
PC0001	PHOTO COUPLER				PC123FY2	G0090036		1-	B3
PC0002	PHOTO COUPLER				PC123FY2	G0090036		1-	B3
Q 0001	TRIAC				BT138D-600	G3090129		1-	E1
Q 0002	FET				2SK1017	G3810170		1-	C1
Q 0003	FET				2SK1017	G3810170		1-	C1
Q 0004	TRANSISTOR				2SC4166-Q	G3341660Q		1-	C3

PS Unit

REF.	DESCRIPTION	VALUE	V/W	TOL.	MFR'S DESIG	VXSTD P/N	VERS.	LOT.	SIDE
Q 0005	TRANSISTOR				DTC114ESA	G3090130		1-	C2
Q 0006	TRANSISTOR				2SC3246H	G3332460H		1-	C2
Q 0021	TRANSISTOR				2PA1015Y	G3090131		1-	A2
Q 0022	TRANSISTOR				2PC1815Y	G3090132		1-	B3
R 0001	CARBON FILM RES.	470k	1/2W	5%	RD50SS470K J	J01279001		1-	D2
R 0002	METAL FILM RES.	100	1W	5%	ERG-1SJ101	J22305101		1-	C2
R 0003	THERMISTOR				8D-13	G9090130		1-	E1
R 0004	CARBON FILM RES.	1k	1/6W	5%	RD16PJ	J01225102		1-	E1
R 0005	METAL FILM RES.	100	1W	5%	ERG-1SJ101	J22305101		1-	C2
R 0006	METAL FILM RES.	100k	1W	5%	ERG-1SJ104	J22309049		1-	D2
R 0007	METAL FILM RES.	100k	1W	5%	ERG-1SJ104	J22309049		1-	D2
R 0008	CARBON FILM RES.	1M	1/6W	5%	RD16PJ105	J01225105		1-	C3
R 0009	CARBON FILM RES.	1M	1/6W	5%	RD16PJ105	J01225105		1-	C3
R 0010	CARBON FILM RES.	68k	1/6W	5%	RD16PJ683	J01225683		1-	C3
R 0011	CARBON FILM RES.	7.5k	1/6W	5%	RD16PJ752	J01225752		1-	C2
R 0012	CARBON FILM RES.	10	1/6W	5%	RD16PJ100	J01225100		1-	C1
R 0013	CARBON FILM RES.	10	1/6W	5%	RD16PJ100	J01225100		1-	C1
R 0014	CARBON FILM RES.	4.7k	1/6W	5%	RD16PJ472	J01225472		1-	C2
R 0015	CARBON FILM RES.	220k	1/6W	5%	RD16PJ224	J01225224		1-	C3
R 0016	CARBON FILM RES.	1.2k	1/6W	5%	RD16PJ122	J01225122		1-	C3
R 0017	CARBON FILM RES.	220k	1/6W	5%	RD16PJ224	J01225224		1-	C1
R 0018	CARBON FILM RES.	47k	1/6W	5%	RD16PJ473	J01225473		1-	C2
R 0019	CARBON FILM RES.	27k	1/6W	5%	RD16PJ273	J01225273		1-	C1
R 0020	CARBON FILM RES.	3k	1/6W	5%	RD16PJ302	J01225302		1-	C2
R 0021	CARBON FILM RES.	22	1/6W	5%	RD16PJ220	J01225220		1-	C1
R 0022	CARBON FILM RES.	2.2	1/6W	5%	RD16PJ2R2	J01225229		1-	A2
R 0023	CEMENT RES.	0.01	5W	10%	MPC75 0.01 K	J30379003		1-	A2
R 0024	CEMENT RES.	0.01	5W	10%	MPC75 0.01 K	J30379003		1-	A2
R 0025	CARBON FILM RES.	1k	1/6W	5%	RD16PJ102	J01225102		1-	A2
R 0026	CARBON FILM RES.	6.8k	1/6W	5%	RD16PJ682	J01225682		1-	A2
R 0027	CARBON FILM RES.	6.8k	1/6W	5%	RD16PJ682	J01225682		1-	A2
R 0028	CARBON FILM RES.	22k	1/6W	5%	RD16PJ223	J01225223		1-	A2
R 0029	CARBON FILM RES.	22k	1/6W	5%	RD16PJ223	J01225223		1-	B3
R 0030	CARBON FILM RES.	100	1/6W	5%	RD16PJ101	J01225101		1-	A2
R 0031	CARBON FILM RES.	100	1/6W	5%	RD16PJ101	J01225101		1-	A3
R 0032	CARBON FILM RES.	3k	1/6W	5%	RD16PJ302	J01225302		1-	A3
R 0033	CARBON FILM RES.	150k	1/6W	5%	RD16PJ154	J01225154		1-	A2
R 0035	CARBON FILM RES.	1k	1/6W	5%	RD16PJ102	J01225102		1-	A3
R 0036	CARBON FILM RES.	470	1/6W	5%	RD16PJ471	J01225471		1-	A3
R 0037	CARBON FILM RES.	20k	1/6W	5%	RD16PJ203	J01225203		1-	A3
R 0038	CARBON FILM RES.	22k	1/6W	5%	RD16PJ223	J01225223		1-	A3
R 0039	CARBON FILM RES.	470	1/6W	5%	RD16PJ471	J01225471		1-	A2
R 0040	CARBON FILM RES.	820	1/6W	5%	RD16PJ821	J01225821		1-	A2
R 0041	CARBON FILM RES.	470	1/6W	5%	RD16PJ471	J01225471		1-	B3
T 0001	CONVERTER TRANS.				FP2017A-501	S8100822		1-	B1
T 0002	CONVERTER TRANS.				FP2017A-501	S8100822		1-	B2
	TERMINAL (4pcs)				P91250 TAB	Q5000154		1-	
	FUSE CLIP (2pcs)				F220P	P2000064		1-	
	AC SELECTER				SK1019A-B	S8100823		1-	
	TERMINAL (2pcs)				RT-01N-2.3A	Q5000153		1-	
	MODULE				MB2013A	S8100824		1-	
	CABLE ASSY(B)				FP2017A-802	S8100825		1-	
	CABLE ASSY(C)				FP2017A-803	S8100826		1-	
	CABLE ASSY(D)				FP2017A-804	S8100827		1-	
	CABLE ASSY(E)				FP2017A-805	S8100828		1-	
	CABLE ASSY(F)				FP2017A-806	S8100829		1-	
	HEATSINK				FP2017A-611	S8001785		1-	
	HEATSINK(S)				FP2017A-613	S8001787		1-	
	FITTING A				FP2017A-614	S8001788		1-	
	FITTING B				FP2017A-615	S8001789		1-	

REF.	DESCRIPTION	VALUE	V/W	TOL.	MFR'S DESIG	VXSTD P/N	VERS.	LOT.	SIDE
	THERMAL CONDUCTER				FP2017A-701	S8001790		1-	
	THERMAL CONDUCTER				FB419	S8001781		1-	
	THERMAL CONDUCTER	(4pcs)			TC45A-(CP-T0-3P)	S8001782		1-	
	THERMAL CONDUCTER				TC45A-(CP-T0-220)	S8001783		1-	
	FITTING (5pcs)				FR336A	S8001784		1-	
	FITTING				FR309A	S8000030		1-	
	SPACER (5pcs)				8MM	S8001794		1-	
	COVER				FP2017A-612	S8001786		1-	



Copyright 2006
VERTEX STANDARD CO., LTD.
All rights reserved

No portion of this manual
may be reproduced without
the permission of
VERTEX STANDARD CO., LTD.

